



Part No: GF1003M

Date: 9/20/2006

Unit: mm

Description: speaker

Page No: 1 of 2



Specifications

Nominal Size	100 mm (4.00 in)	(See attached drawing)
Impedance	8 Ohm \pm 15%	at 800 Hz 1 V
Resonant frequency	250 Hz \pm 50 Hz	at 1 V
Sound pressure level	93 dB/w \pm 3 dB	1 w 50 cm ave. at 0.5K, 0.6K, 0.8K, 1.0K Hz
Response	Fo Hz ~ 13 KHz max 10 dB	
Input power	Nominal 3 W	Handling capacity 5 W
Operation	must be normal at program source 3 W	
Buzz, rattle, etc.	must be normal at sine wave 4.89 V	
Magnet	Size: 45 x 22 x 8 mm	
Load test	White noise 3 W	for 48 hours
Heat test	70 \pm 2° C	20-50% R.H. 48 hours
Humidity test	40 \pm 2° C	90-95% R.H. 48 hours

Frequency Response Curve

Potentiometer range	50 dB
Rectifier	RMS
Lower limit frequency	20 Hz
Wr. speed	100 mm/sec

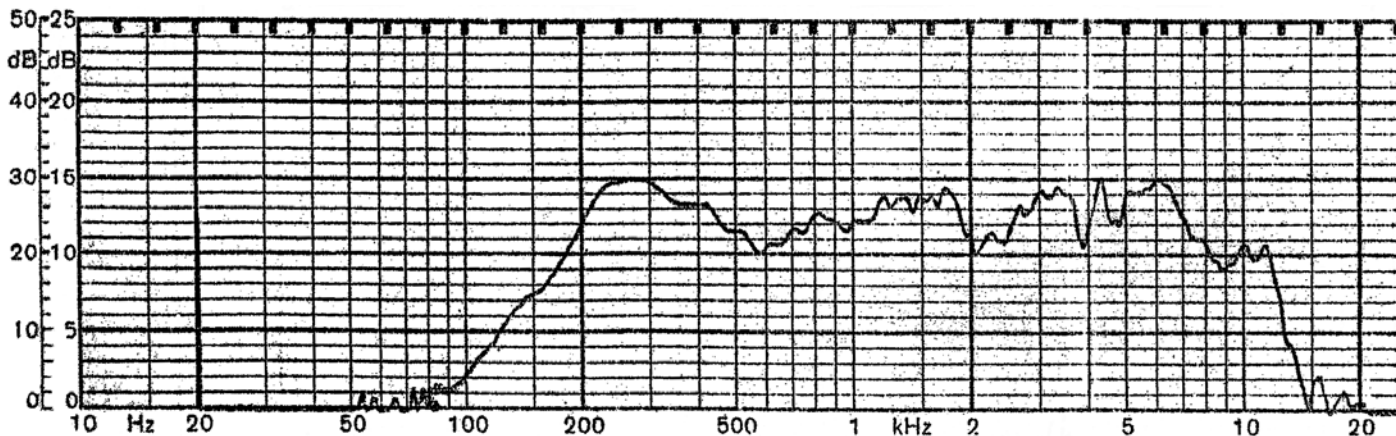

Zero level 70 dB

REV.	DESCRIPTION	DATE
A	NEW DRAWING	8/8/2006

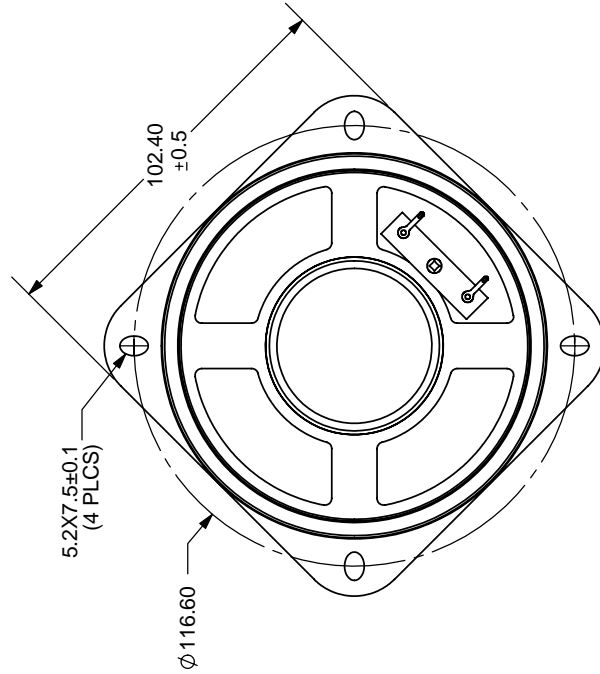
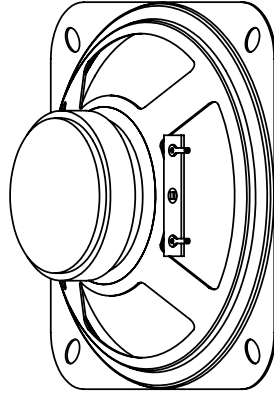
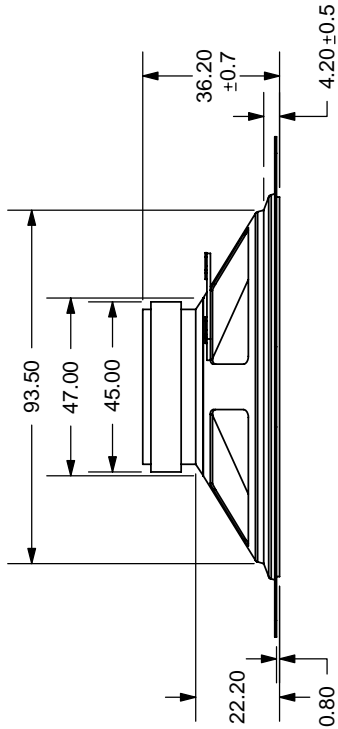

TOLERANCE:
±0.5mm UNLESS OTHERWISE
SPECIFIED



CUI INC

20050 SW 112th Ave.
Tualatin, OR 97062
Phone: 503-643-4899
800-275-4899
Fax: 503-372-1266
Website: www.cui.com

TITLE: Square frame mylar cone - ferrite magnet	REV: A
PART NO: GF1003M	UNITS: MM [INCHES]
DRAWN BY: ZRJ	APPROVED BY:
	SCALE: 1:2