

## BCD-TO-DECIMAL DECODER

- BCD-TO-DECIMAL DECODING OR BINARY-TO-OCTAL DECODING
- HIGH DECODED OUTPUT DRIVE CAPABILITY
- "POSITIVE LOGIC" INPUTS AND OUTPUTS : DECODED OUTPUTS GO HIGH ON SELECTION
- MEDIUM-SPEED OPERATION :  $t_{PHL}$ ,  $t_{PLH}$  = 80ns (typ.) @  $V_{DD} = 10V$
- STANDARDIZED SYMMETRICAL OUTPUT CHARACTERISTICS
- QUIESCENT CURRENT SPECIFIED TO 20V FOR HCC DEVICE
- 5V, 10V, AND 15V PARAMETRIC RATINGS
- INPUT CURRENT OF 100nA AT 18V AND 25°C FOR HCC DEVICE
- 100% TESTED FOR QUIESCENT CURRENT
- MEETS ALL REQUIREMENTS OF JEDEC TENTATIVE STANDARD N° 13A, "STANDARD SPECIFICATIONS FOR DESCRIPTION OF "B" SERIES CMOS DEVICES"

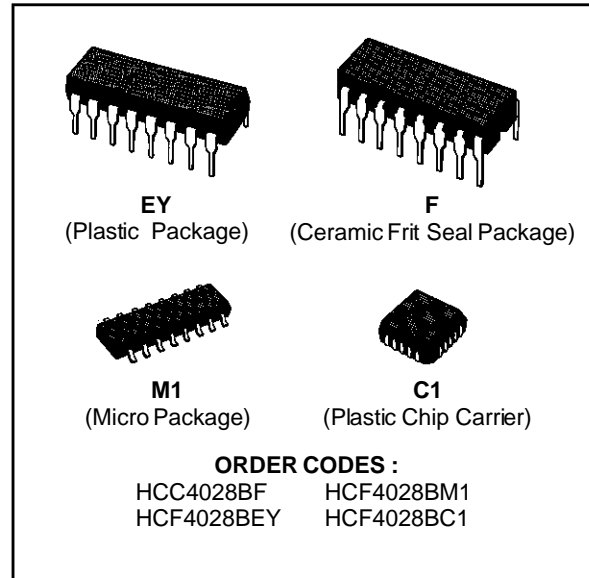

### DESCRIPTION

The **HCC4028B** (extended temperature range) and **HCF4028B** (intermediate temperature range) are monolithic integrated circuit, available in 16-lead dual in-line plastic or ceramic package and plastic micropackage.

The **HCC/HCF4028B** types are BCD-to-decimal or binary-to-octal decoders consisting of buffering on all 4 inputs, decoding-logic gates, and 10 output buffers. A BCD code applied to the four inputs, A to D, results in a high level at the selected one of 10 decimal decoded outputs. Similarly, a 3-bit binary code applied to inputs A through C is decoded in octal code at output 0 to 7 if D = "0". High drive capability is provided at all outputs to enhance dc and dynamic performance in high fan-out applications.

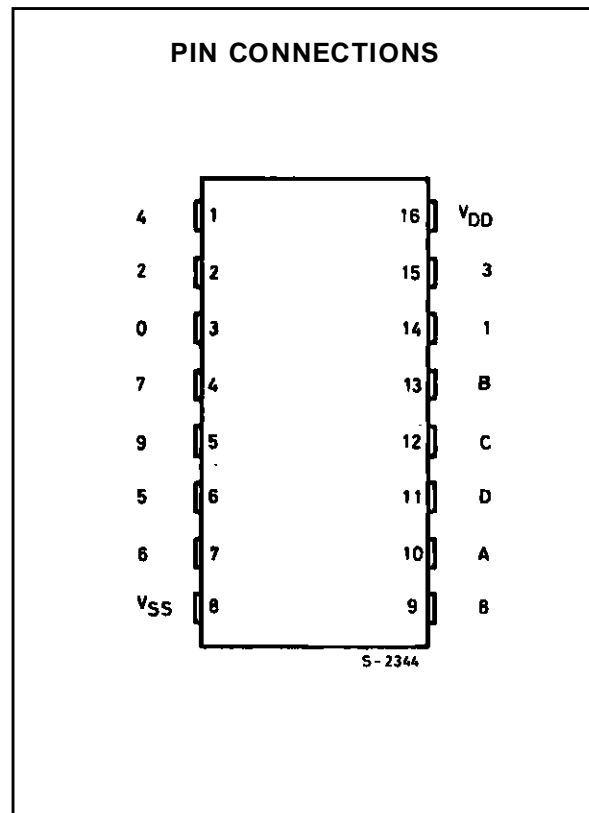

# HCC/HCF4028B

## FUNCTIONAL DIAGRAM

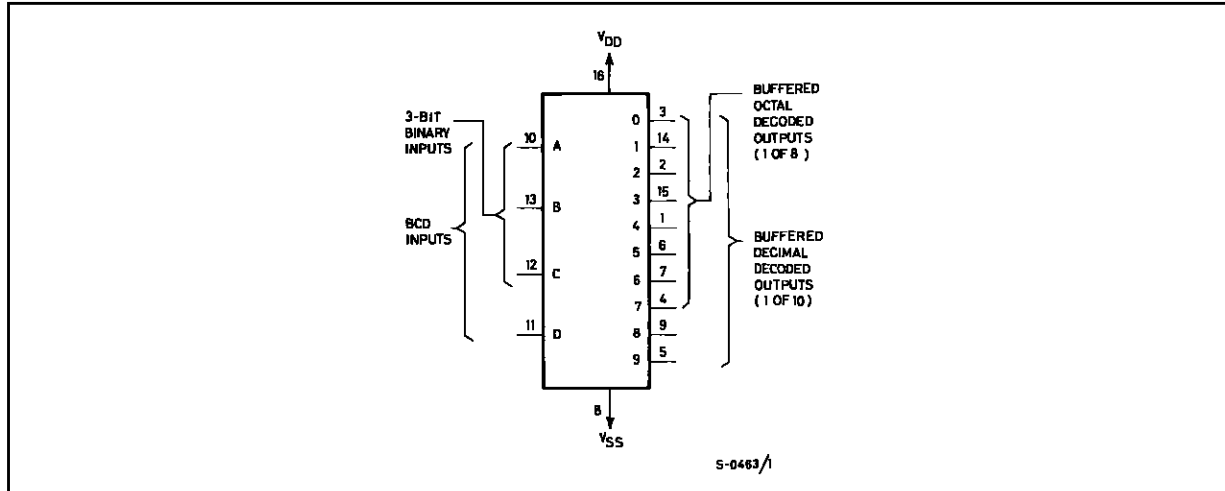

## ABSOLUTE MAXIMUM RATINGS

Symbol	Parameter	Value	Unit
$V_{DD}^*$	Supply Voltage : <b>HCC</b> Types <b>HCF</b> Types	- 0.5 to + 20	V
		- 0.5 to + 18	V
$V_i$	Input Voltage	- 0.5 to $V_{DD} + 0.5$	V
$I_i$	DC Input Current (any one input)	$\pm 10$	mA
$P_{tot}$	Total Power Dissipation (per package) Dissipation per Output Transistor for $T_{op} =$ Full Package-temperature Range	200	mW
		100	mW
$T_{op}$	Operating Temperature : <b>HCC</b> Types <b>HCF</b> Types	- 55 to + 125	$^{\circ}C$
		- 40 to + 85	$^{\circ}C$
$T_{stg}$	Storage Temperature	- 65 to + 150	$^{\circ}C$

Stresses above those listed under "Absolute Maximum Ratings" may cause permanent damage to the device. This is a stress rating only and functional operation of the device at these or any other conditions above those indicated in the operational sections of this specification is not implied. Exposure to absolute maximum rating conditions for external periods may affect device reliability.

\* All voltage values are referred to  $V_{SS}$  pin voltage.

## RECOMMENDED OPERATING CONDITIONS

Symbol	Parameter	Value	Unit
$V_{DD}$	Supply Voltage : <b>HCC</b> Types <b>HCF</b> Types	3 to 18	V
		3 to 15	V
$V_i$	Input Voltage	0 to $V_{DD}$	V
$T_{op}$	Operating Temperature : <b>HCC</b> Types <b>HCF</b> Types	- 55 to + 125	$^{\circ}C$
		- 40 to + 85	$^{\circ}C$

LOGIC DIAGRAM AND TRUTH TABLE

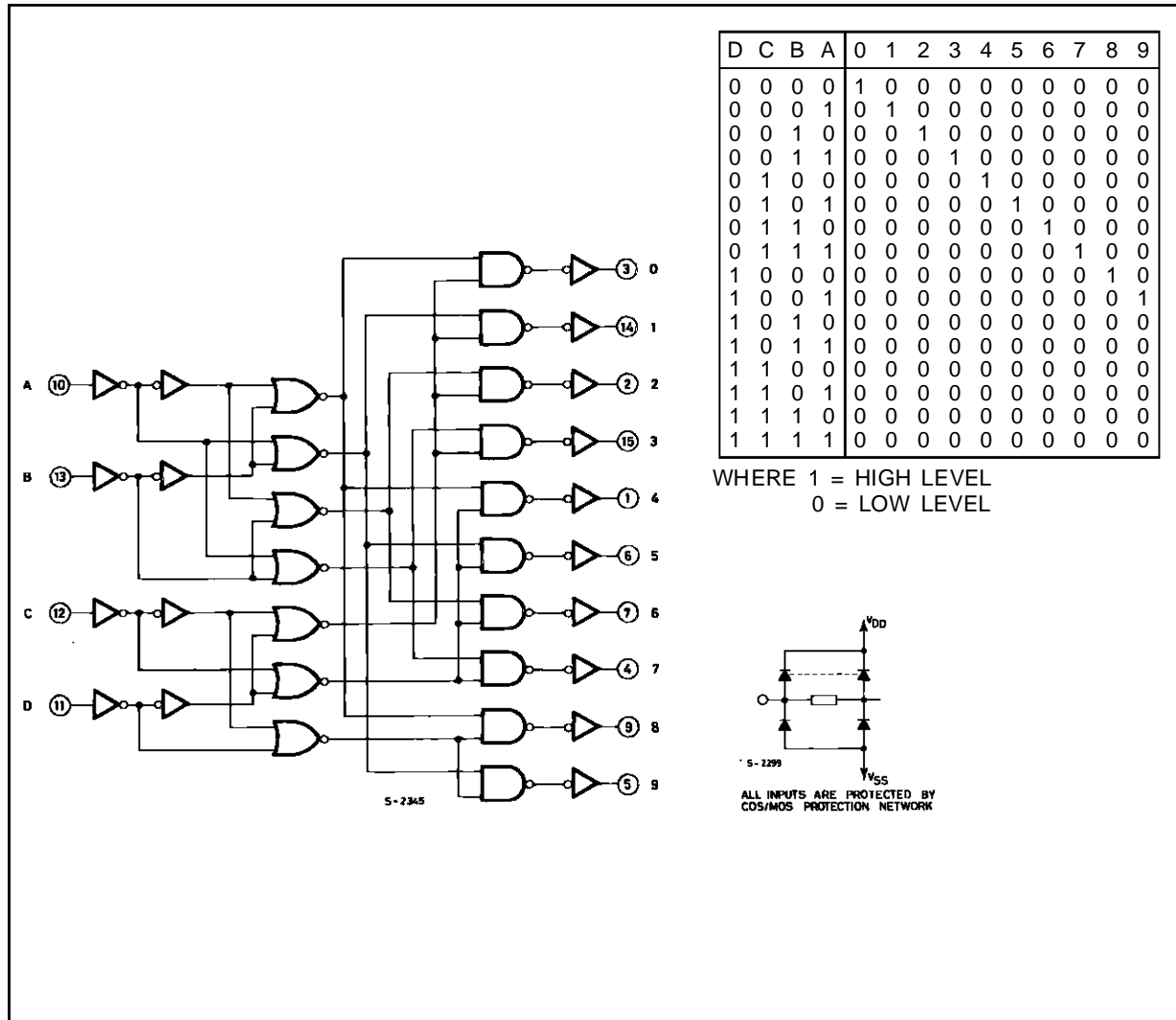

D	C	B	A	0	1	2	3	4	5	6	7	8	9
0	0	0	0	1	0	0	0	0	0	0	0	0	0
0	0	0	1	0	1	0	0	0	0	0	0	0	0
0	0	1	0	0	0	1	0	0	0	0	0	0	0
0	0	1	1	0	0	0	1	0	0	0	0	0	0
0	1	0	0	0	0	0	0	1	0	0	0	0	0
0	1	0	1	0	0	0	0	0	1	0	0	0	0
0	1	1	0	0	0	0	0	0	0	1	0	0	0
0	1	1	1	0	0	0	0	0	0	0	1	0	0
1	0	0	0	0	0	0	0	0	0	0	0	1	0
1	0	0	1	0	0	0	0	0	0	0	0	0	1
1	0	1	0	0	0	0	0	0	0	0	0	0	0
1	0	1	1	0	0	0	0	0	0	0	0	0	0
1	1	0	0	0	0	0	0	0	0	0	0	0	0
1	1	0	1	0	0	0	0	0	0	0	0	0	0
1	1	1	0	0	0	0	0	0	0	0	0	0	0
1	1	1	1	0	0	0	0	0	0	0	0	0	0

WHERE 1 = HIGH LEVEL  
0 = LOW LEVEL

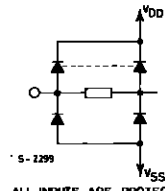

ALL INPUTS ARE PROTECTED BY CDS/MOS PROTECTION NETWORK

# HCC/HCF4028B

## STATIC ELECTRICAL CHARACTERISTICS (over recommended operating conditions)

Symbol	Parameter		Test Conditions				Value						Unit	
			V <sub>I</sub> (V)	V <sub>O</sub> (V)	I <sub>O</sub>   ( $\mu$ A)	V <sub>DD</sub> (V)	T <sub>Low</sub> *		25°C			T <sub>High</sub> *		
							Min.	Max.	Min.	Typ.	Max.	Min.		Max.
I <sub>L</sub>	Quiescent Current	HCC Types	0/ 5			5		5		0.04	5		150	$\mu$ A
			0/10			10		10		0.04	10		300	
			0/15			15		20		0.04	20		600	
			0/20			20		100		0.08	100		3000	
		HCF Types	0/ 5			5		20		0.04	20		150	
			0/10			10		40		0.04	40		300	
V <sub>OH</sub>	Output High Voltage		0/ 5		< 1	5	4.95		4.95		4.95		V	
			0/10		< 1	10	9.95		9.95		9.95			
			0/15		< 1	15	14.95		14.95		14.95			
V <sub>OL</sub>	Output Low Voltage		5/0		< 1	5		0.05		0.05		0.05	V	
			10/0		< 1	10		0.05		0.05		0.05		
			15/0		< 1	15		0.05		0.05		0.05		
V <sub>IH</sub>	Input High Voltage			0.5/4.5	< 1	5	3.5		3.5		3.5		V	
				1/9	< 1	10	7		7		7			
				1.5/13.5	< 1	15	11		11		11			
V <sub>IL</sub>	Input Low Voltage			4.5/0.5	< 1	5		1.5		1.5		1.5	V	
				9/1	< 1	10		3		3		3		
				13.5/1.5	< 1	15		4		4		4		
I <sub>OH</sub>	Output Drive Current	HCC Types	0/5	2.5		5	- 2		- 1.6	- 3.2		- 1.15	mA	
			0/5	4.6		5	- 0.64		- 0.51	- 1		- 0.36		
			0/10	9.5		10	- 1.6		- 1.3	- 2.6		- 0.9		
			0/15	13.5		15	- 4.2		- 3.4	- 6.8		- 2.4		
		HCF Types	0/5	2.5		5	- 1.53		- 1.36	- 3.2		- 1.1		
			0/5	4.6		5	- 0.52		- 0.44	- 1		- 0.36		
			0/10	9.5		10	- 1.3		- 1.1	- 2.6		- 0.9		
			0/15	13.5		15	- 3.6		- 3.0	- 6.8		- 2.4		
I <sub>OL</sub>	Output Sink Current	HCC Types	0/5	0.4		5	0.64		0.51	1		0.36	mA	
			0/10	0.5		10	1.6		1.3	2.6		0.9		
			0/15	1.5		15	4.2		3.4	6.8		2.4		
		HCF Types	0/5	0.4		5	0.52		0.44	1		0.36		
			0/10	0.5		10	1.3		1.1	2.6		0.9		
			0/15	1.5		15	3.6		3.0	6.8		2.4		
I <sub>IH</sub> , I <sub>IL</sub>	Input Leakage Current	HCC Types	0/18	Any Input		18		$\pm$ 0.1		$\pm$ 10 <sup>-5</sup>	$\pm$ 0.1		$\pm$ 1	$\mu$ A
		HCF Types	0/15			15		$\pm$ 0.3		$\pm$ 10 <sup>-5</sup>	$\pm$ 0.3		$\pm$ 1	
C <sub>I</sub>	Input Capacitance		Any Input						5	7.5			pF	

\* T<sub>Low</sub> = - 55°C for HCC device : - 40°C for HCF device.

\* T<sub>High</sub> = + 125°C for HCC device : + 85°C for HCF device.

The Noise Margin for both "1" and "0" levels is : 1V min. with V<sub>DD</sub> = 5V, 2V min. with V<sub>DD</sub> = 10V, 2.5 V min. with V<sub>DD</sub> = 15V.

**DYNAMIC ELECTRICAL CHARACTERISTICS** ( $T_{amb} = 25^{\circ}\text{C}$ ,  $C_L = 50\text{pF}$ ,  $R_L = 200\text{k}\Omega$ , typical temperature coefficient for all  $V_{DD}$  values is  $0.3\%/^{\circ}\text{C}$ , all input rise and fall times =  $20\text{ns}$ )

Symbol	Parameter	Test Conditions		Value			Unit
			$V_{DD}$ (V)	Min.	Typ.	Max.	
$t_{PHL}$ , $t_{PLH}$	Propagation Delay Time (clock to "out")		5		175	350	ns
			10		80	160	
			15		60	120	
$t_{THL}$ , $t_{TLH}$	Transition Time		5		100	200	ns
			10		50	100	
			15		40	80	

Minimum Output High (source) Current Characteristics.

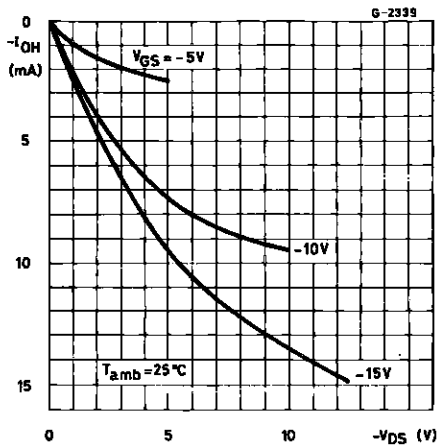

Typical Output Low (sink) Current.

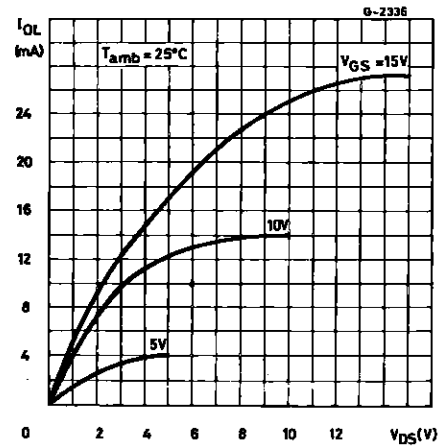

Minimum Output Low (Sink) Current Characteristics.

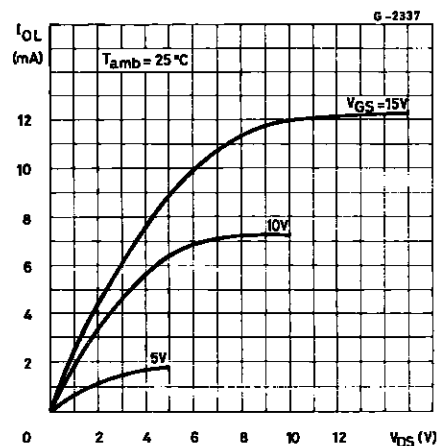

Typical Output High (source) Current Characteristics.

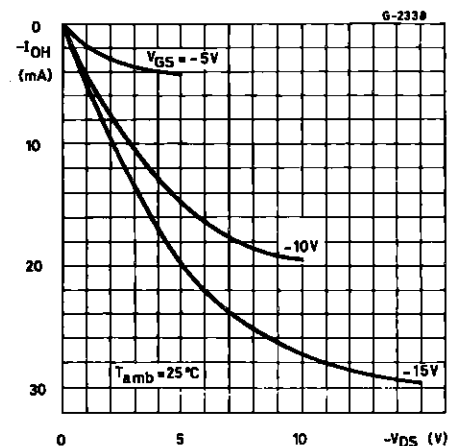

# HCC/HCF4028B

Typical Propagation Delay Time as a Function load Capacitance.

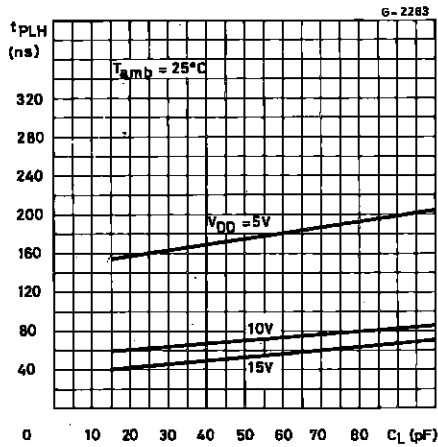

Typical Dynamic Power Dissipation as a Function of Input Frequency .

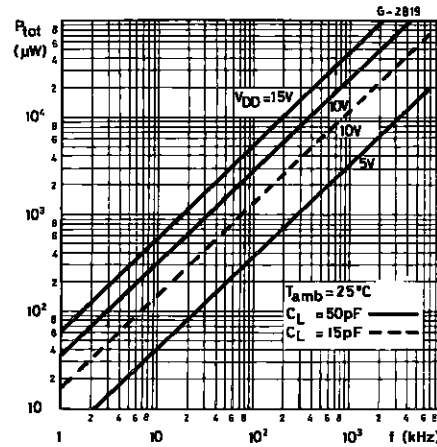

## TYPICAL APPLICATIONS

The circuit shown in fig. 1 converts any 4-bit code to a decimal or hexadecimal code Fig 2 shows a number of codes and the decimal or hexadecimal number in these codes which must be applied to the input pins of the HCC/HCF4028B to select a particu-

lar output. For example : in order to get a "high" on output n8 the input must be either an 8 expressed in 4-bit binary code, a 15 expressed in 4-bit gray code, or a 5 expressed in excess-3code.

Figure 1 : Code Conversion Circuit.

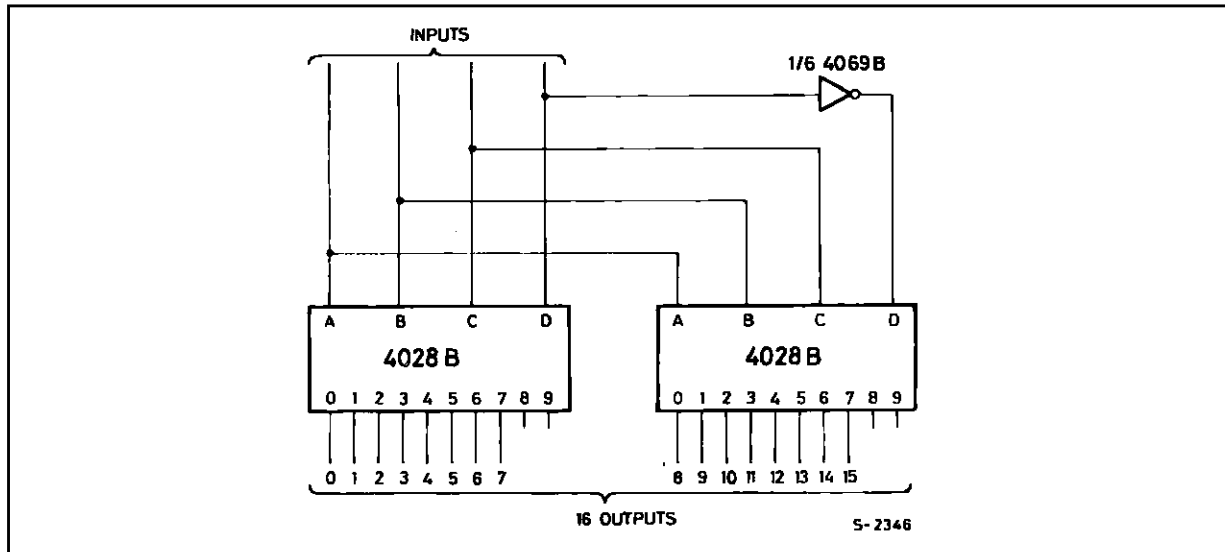

Figure 2 : Code Conversion Chart.

INPUTS	INPUT CODES					OUTPUT NUMBER																	
	Hexa Decimal		Decimal			4221	0	1	2	3	4	5	6	7	8	9	10	11	12	13	14	15	
	4 BIT BINARY	4 BIT GRAY	EXCESS 3	EXCESS 3 GRAY	AIKEN																		
D C B A	0 0 0 0	0 0 0 0	0	0	0	0	0	0	0	0	0	0	0	0	0	0	0	0	0	0	0	0	0
	0 0 0 1	0 0 0 1	1	1	1	1	0	1	0	0	0	0	0	0	0	0	0	0	0	0	0	0	0
	0 0 1 0	0 0 1 0	2	3	2	2	0	2	0	1	0	0	0	0	0	0	0	0	0	0	0	0	0
	0 0 1 1	0 0 1 1	3	2	3	3	0	3	0	1	0	0	0	0	0	0	0	0	0	0	0	0	0
	0 1 0 0	0 1 0 0	4	7	4	4	1	4	0	0	1	0	0	0	0	0	0	0	0	0	0	0	0
	0 1 0 1	0 1 0 1	5	6	5	3	2	3	0	0	1	0	0	0	0	0	0	0	0	0	0	0	0
	0 1 1 0	0 1 1 0	6	4	6	4	3	4	0	0	0	1	0	0	0	0	0	0	0	0	0	0	0
	0 1 1 1	0 1 1 1	7	5	7	5	4	5	0	0	0	0	1	0	0	0	0	0	0	0	0	0	0
	1 0 0 0	1 0 0 0	8	15	8	6	5	6	0	0	0	0	0	0	1	0	0	0	0	0	0	0	0
	1 0 0 1	1 0 0 1	9	14	9	7	6	7	0	0	0	0	0	0	1	0	0	0	0	0	0	0	0
	1 0 1 0	1 0 1 0	10	12	10	7	7	8	0	0	0	0	0	0	0	0	1	0	0	0	0	0	0
	1 0 1 1	1 0 1 1	11	13	11	8	8	9	0	0	0	0	0	0	0	0	0	1	0	0	0	0	0
	1 1 0 0	1 1 0 0	12	8	12	9	9	5	0	0	0	0	0	0	0	0	0	0	1	0	0	0	0
	1 1 0 1	1 1 0 1	13	9	13	6	6	7	0	0	0	0	0	0	0	0	0	0	0	1	0	0	0
	1 1 1 0	1 1 1 0	14	11	14	8	8	8	0	0	0	0	0	0	0	0	0	0	0	0	0	1	0
	1 1 1 1	1 1 1 1	15	10	15	7	7	9	0	0	0	0	0	0	0	0	0	0	0	0	0	0	1

# HCC/HCF4028B

## TYPICAL APPLICATIONS (continued)

Figure 3 : 6-bit binary to 1 of 64 Address Decoder.

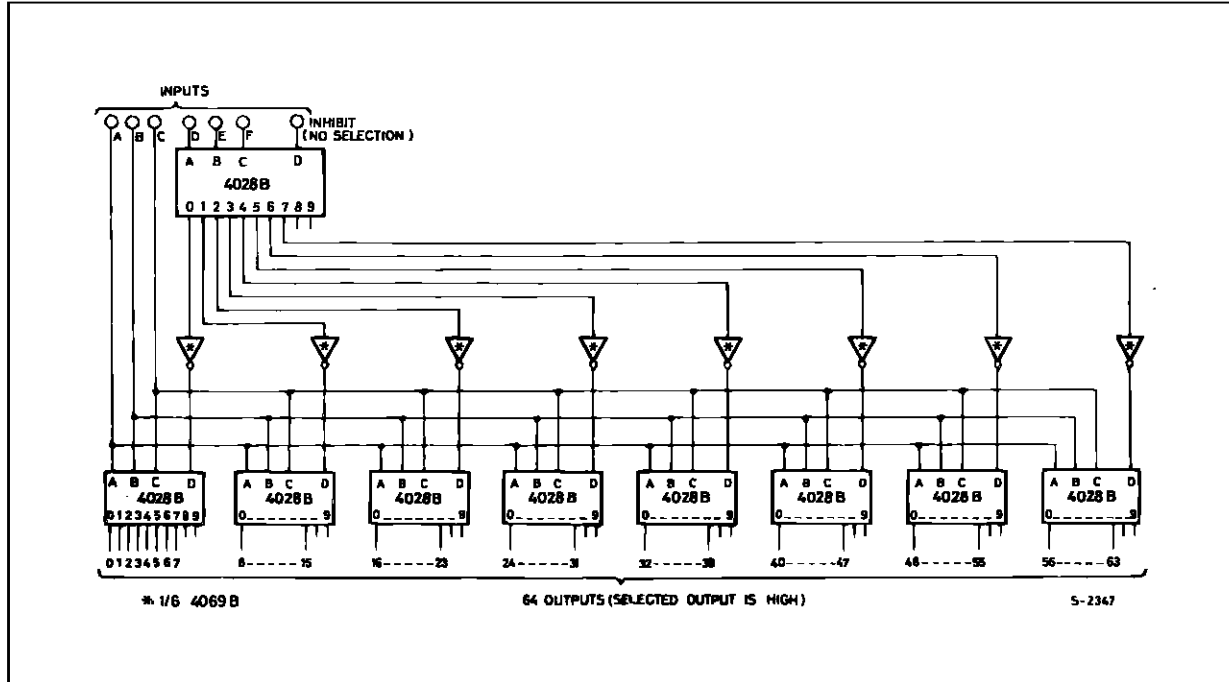
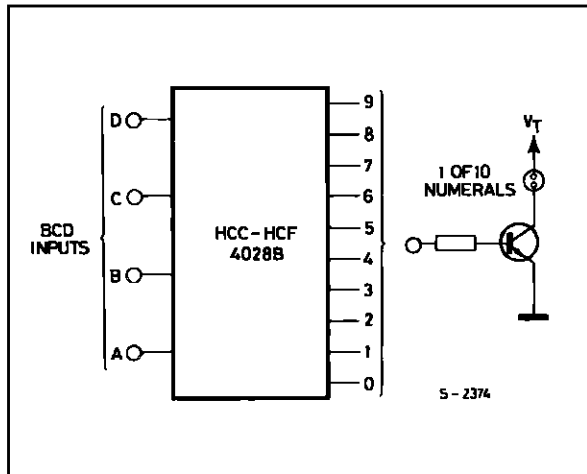

Figure 4 : Neon Readout (nixie tube) Display Application.





TEST CIRCUITS

Quiescent Device Current.

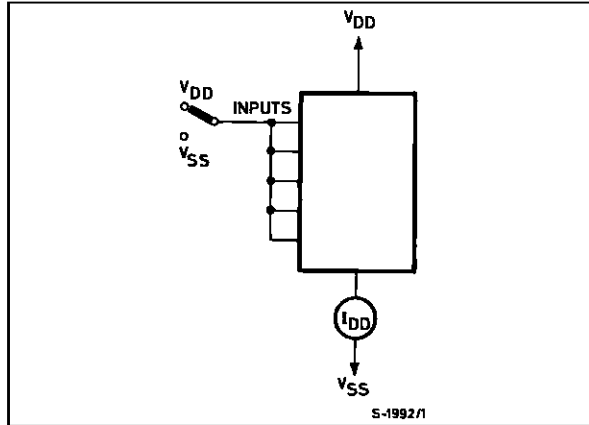

Noise Immunity.

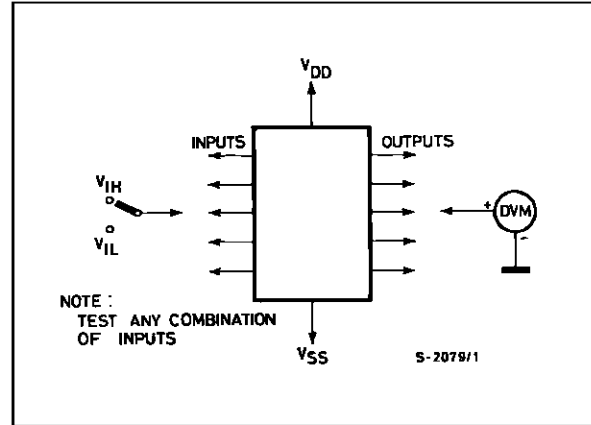

Input Leakage Current.

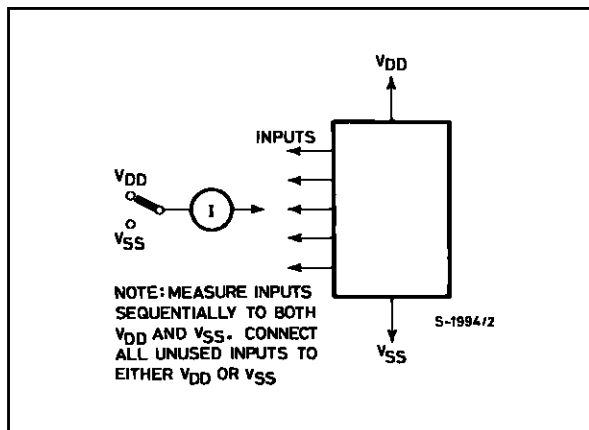

Dynamic Power Dissipation.

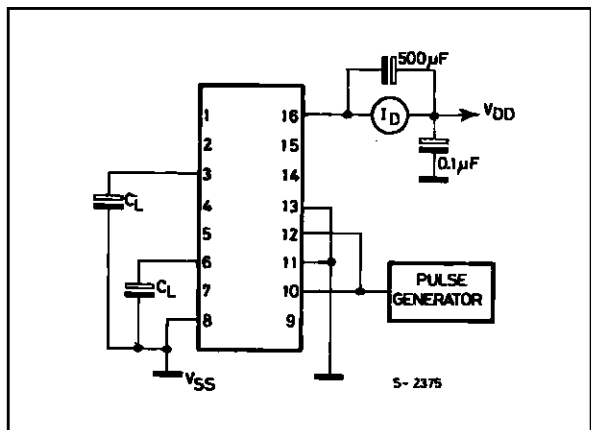

Typical Transition Time vs. Load Capacitance.

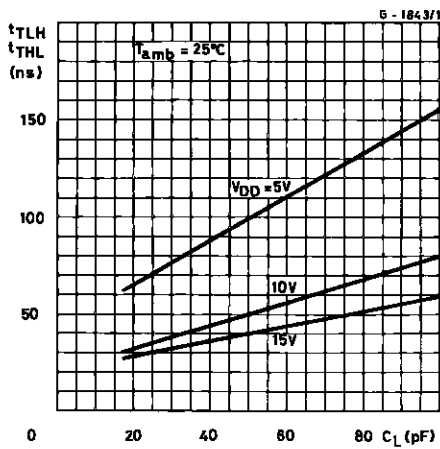

**Plastic DIP16 (0.25) MECHANICAL DATA**

DIM.	mm			inch		
	MIN.	TYP.	MAX.	MIN.	TYP.	MAX.
a1	0.51			0.020		
B	0.77		1.65	0.030		0.065
b		0.5			0.020	
b1		0.25			0.010	
D			20			0.787
E		8.5			0.335	
e		2.54			0.100	
e3		17.78			0.700	
F			7.1			0.280
I			5.1			0.201
L		3.3			0.130	
Z			1.27			0.050



P001C

Ceramic DIP16/1 MECHANICAL DATA

DIM.	mm			inch		
	MIN.	TYP.	MAX.	MIN.	TYP.	MAX.
A			20			0.787
B			7			0.276
D		3.3			0.130	
E	0.38			0.015		
e3		17.78			0.700	
F	2.29		2.79	0.090		0.110
G	0.4		0.55	0.016		0.022
H	1.17		1.52	0.046		0.060
L	0.22		0.31	0.009		0.012
M	0.51		1.27	0.020		0.050
N			10.3			0.406
P	7.8		8.05	0.307		0.317
Q			5.08			0.200



**SO16 (Narrow) MECHANICAL DATA**

DIM.	mm			inch		
	MIN.	TYP.	MAX.	MIN.	TYP.	MAX.
A			1.75			0.068
a1	0.1		0.2	0.004		0.007
a2			1.65			0.064
b	0.35		0.46	0.013		0.018
b1	0.19		0.25	0.007		0.010
C		0.5			0.019	
c1	45° (typ.)					
D	9.8		10	0.385		0.393
E	5.8		6.2	0.228		0.244
e		1.27			0.050	
e3		8.89			0.350	
F	3.8		4.0	0.149		0.157
G	4.6		5.3	0.181		0.208
L	0.5		1.27	0.019		0.050
M			0.62			0.024
S	8° (max.)					



P013H

**PLCC20 MECHANICAL DATA**

DIM.	mm			inch		
	MIN.	TYP.	MAX.	MIN.	TYP.	MAX.
A	9.78		10.03	0.385		0.395
B	8.89		9.04	0.350		0.356
D	4.2		4.57	0.165		0.180
d1		2.54			0.100	
d2		0.56			0.022	
E	7.37		8.38	0.290		0.330
e		1.27			0.050	
e3		5.08			0.200	
F		0.38			0.015	
G			0.101			0.004
M		1.27			0.050	
M1		1.14			0.045	



Information furnished is believed to be accurate and reliable. However, SGS-THOMSON Microelectronics assumes no responsibility for the consequences of use of such information nor for any infringement of patents or other rights of third parties which may result from its use. No license is granted by implication or otherwise under any patent or patent rights of SGS-THOMSON Microelectronics. Specifications mentioned in this publication are subject to change without notice. This publication supersedes and replaces all information previously supplied. SGS-THOMSON Microelectronics products are not authorized for use as critical components in life support devices or systems without express written approval of SGS-THOMSON Microelectronics.

© 1994 SGS-THOMSON Microelectronics - All Rights Reserved

SGS-THOMSON Microelectronics GROUP OF COMPANIES

Australia - Brazil - France - Germany - Hong Kong - Italy - Japan - Korea - Malaysia - Malta - Morocco - The Netherlands -  
Singapore - Spain - Sweden - Switzerland - Taiwan - Thailand - United Kingdom - U.S.A