

STANDARD RECOVERY DIODES

Stud Version

Features

- High surge current capability
- Designed for a wide range of applications
- Stud cathode and stud anode version
- Leaded version available
- Types up to 1600V V_{RRM}

40A

Typical Applications

- Battery charges
- Converters
- Power supplies
- Machine tool controls

Major Ratings and Characteristics

Parameters	40HF(R)		Units
	10 to 120	140 to 160	
$I_{F(AV)}$	40	40	A
@ T_C	140	110	°C
$I_{F(RMS)}$	62		A
I_{FSM}	@ 50Hz	570	A
	@ 60Hz	595	A
I^2t	@ 50Hz	1600	A ² s
	@ 60Hz	1450	A ² s
V_{RRM} range	100 to 1200	1400 to 1600	V
T_J range	- 65 to 190	- 65 to 160	°C



40HF(R) Series

Bulletin I20201 rev. A 09/98

International
IR Rectifier

ELECTRICAL SPECIFICATIONS

Voltage Ratings

Type number	Voltage Code	V_{RRM} : maximum repetitive peak reverse voltage V	V_{RSM} : maximum non-repetitive peak reverse voltage V	$V_{R(BR)}$: minimum avalanche voltage V (1)	I_{RRM} max. @ $T_J = T_J$ max. mA
40HF(R)	10	100	200	--	15
	20	200	300	--	
	40	400	500	500	
	60	600	720	725	9
	80	800	960	950	
	100	1000	1200	1150	
	120	1200	1440	1350	
	140	1400	1650	1550	4.5
160	1600	1900	1750		

(1) Avalanche version only available from V_{RRM} 400V to 1600V.

Forward Conduction

Parameter	40HF(R)		Units	Conditions
	10 to 120	140 to 160		
$I_{F(AV)}$ Max. average forward current @ Case temperature	40	40	A	180° conduction, half sine wave
	140	110	°C	
$I_{F(RMS)}$ Max. RMS forward current	62		A	
P_R Maximum non-repetitive peak reverse power	11		K · W	10µs square pulse, $T_J = T_J$ max. see note (2)
I_{FSM} Max. peak, one-cycle forward, non-repetitive surge current	570	A	t = 10ms	Sinusoidal half wave, Initial $T_J = T_J$ max.
	595		t = 8.3ms	
	480		t = 10ms	
	500		t = 8.3ms	
I^2t Maximum I^2t for fusing	1600	A ² s	t = 10ms	No voltage reappplied
	1450		t = 8.3ms	
	1150		t = 10ms	
	1050		t = 8.3ms	
$I^2\sqrt{t}$ Maximum $I^2\sqrt{t}$ for fusing	16000		A ² √s	t = 0.1 to 10ms, no voltage reappplied
$V_{F(TO)1}$ Low level value of threshold voltage	0.65	V	(16.7% × π × $I_{F(AV)}$ < I < π × $I_{F(AV)}$), $T_J = T_J$ max.	
$V_{F(TO)2}$ High level value of threshold voltage	0.70		(I > π × $I_{F(AV)}$), $T_J = T_J$ max.	
r_{f1} Low level value of forward slope resistance	4.29	mΩ	(16.7% × π × $I_{F(AV)}$ < I < π × $I_{F(AV)}$), $T_J = T_J$ max.	
r_{f2} High level value of forward slope resistance	3.98		(I > π × $I_{F(AV)}$), $T_J = T_J$ max.	
V_{FM} Max. forward voltage drop	1.30	V	$I_{pk} = 125A$, $T_J = 25^\circ C$, $t_p = 400\mu s$ rectangular wave	

(2) Available only for Avalanche version, all other parameters the same as 40HF.

Thermal and Mechanical Specifications

Parameter	40HF(R)		Units	Conditions
	10 to 120	140 to 160		
T _J Max. junction operating temperature range	-65 to 190	-65 to 160	°C	
T _{stg} Max. storage temperature range	-65 to 190	-65 to 160		
R _{thJC} Max. thermal resistance, junction to case	1.0		K/W	DC operation
R _{thCS} Max. thermal resistance, case to heatsink	0.25			Mounting surface, smooth, flat and greased
T Max. allowed mounting torque ±10%	2.3 - 3.4		Nm	Not lubricated threads
	20 - 30		lbf·in	
wt Approximate weight	17 (0.6)		g (oz)	
Case style	DO-203AB (DO5)			See Outline Table

ΔR_{thJC} Conduction

(The following table shows the increment of thermal resistance R_{thJC} when devices operate at different conduction angles than DC)

Conduction angle	Sinusoidal conduction	Rectangular conduction	Units	Conditions
180°	0.14	0.10	K/W	T _J = T _J max.
120°	0.16	0.17		
90°	0.21	0.22		
60°	0.30	0.31		
30°	0.50	0.50		

Ordering Information Table

Device Code											
<table border="1" style="margin: auto;"> <tr> <td style="padding: 5px;">40</td> <td style="padding: 5px;">HF</td> <td style="padding: 5px;">R</td> <td style="padding: 5px;">160</td> <td style="padding: 5px;">M</td> </tr> <tr> <td style="text-align: center;">①</td> <td style="text-align: center;">②</td> <td style="text-align: center;">③</td> <td style="text-align: center;">④</td> <td style="text-align: center;">⑤</td> </tr> </table>	40	HF	R	160	M	①	②	③	④	⑤	<p>1 - 40 = Standard device 41 = Not isolated lead 42 = Isolated lead with silicone sleeve (Red = Reverse polarity) (Blue = Normal polarity)</p> <p>2 - HF = Standard diode HA = Avalanche diode</p> <p>3 - None = Stud Normal Polarity (Cathode to Stud) R = Stud Reverse Polarity (Anode to Stud)</p> <p>4 - Voltage code: Code x 10 = V_{RRM} (See Voltage Ratings table)</p> <p>5 - None = Stud base DO-203AB (DO-5) 1/4" 28UNF-2A M = Stud base DO-203AB (DO-5) M6 X 1 - (Not available for Avalanche diodes)</p>
40	HF	R	160	M							
①	②	③	④	⑤							

40HF(R) Series

Bulletin I20201 rev. A 09/98

Outlines Table

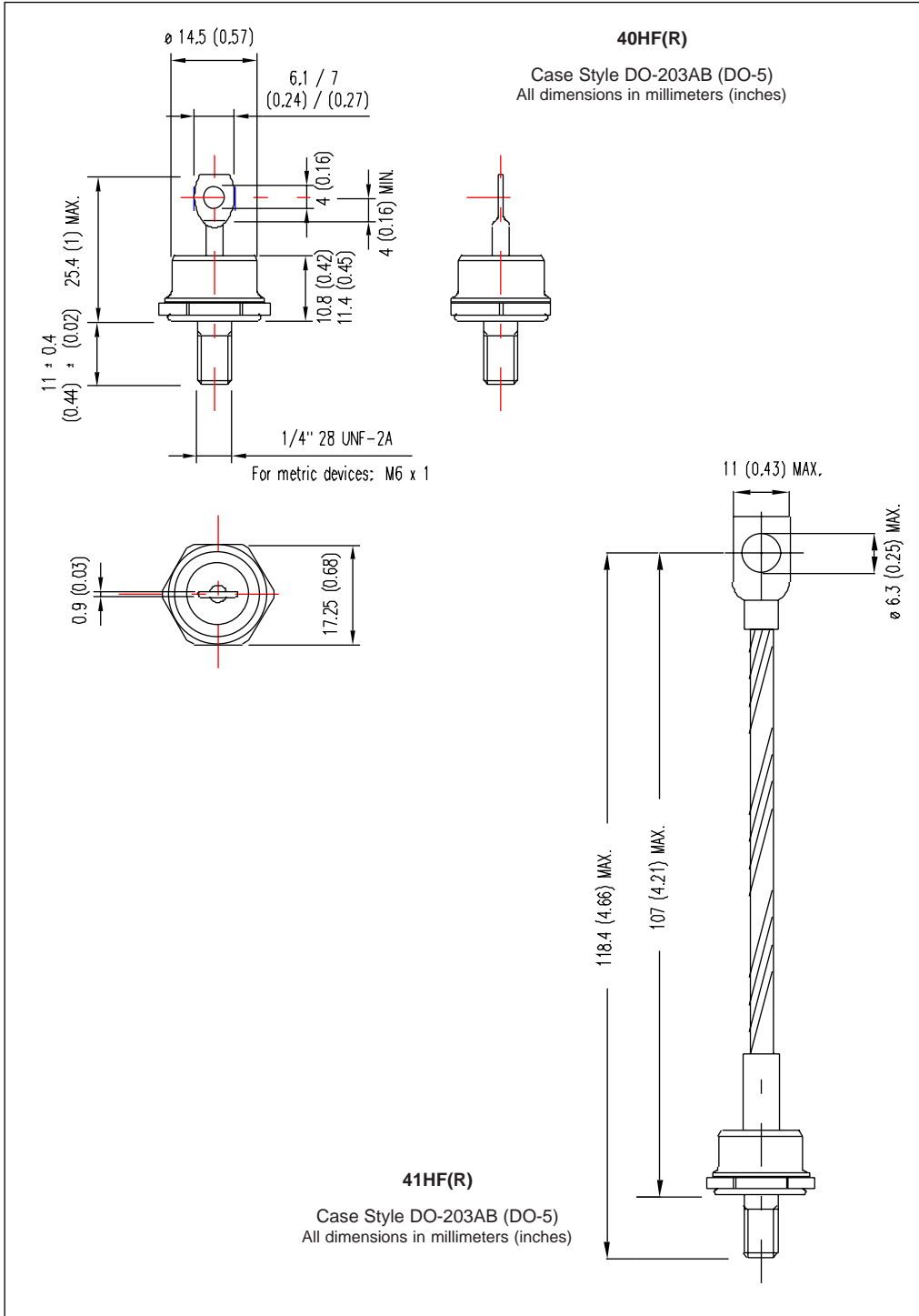

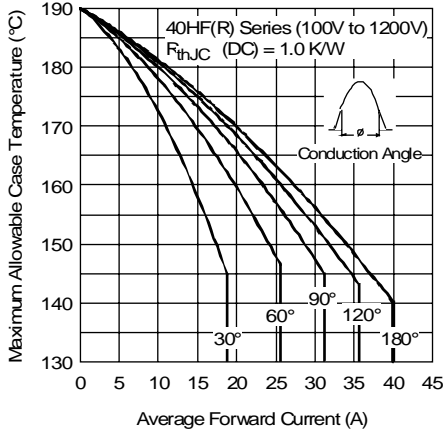

Fig. 1 - Current Ratings Characteristics

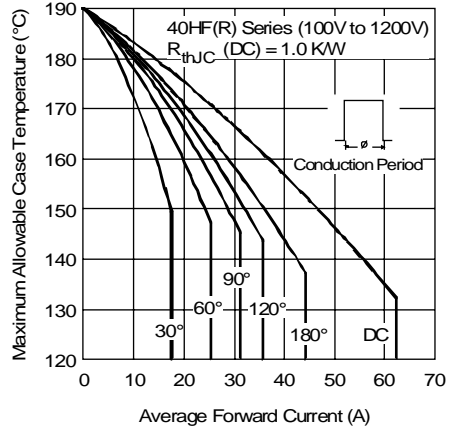

Fig. 2 - Current Ratings Characteristics

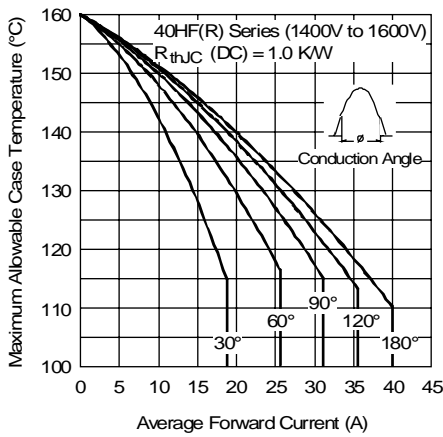

Fig. 3 - Current Ratings Characteristics

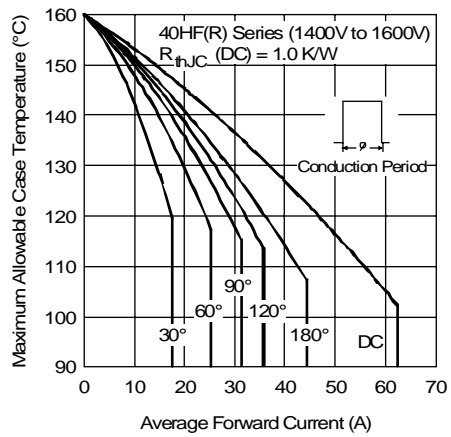

Fig. 4 - Current Ratings Characteristics

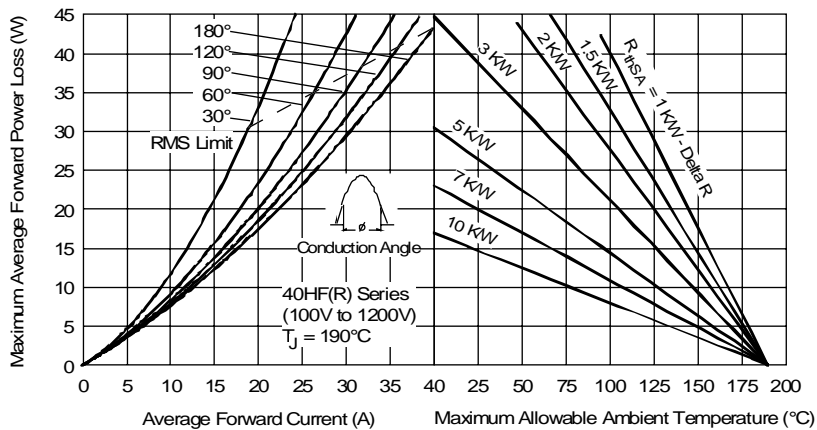

Fig. 5 - Forward Power Loss Characteristics

40HF(R) Series

Bulletin I20201 rev. A 09/98

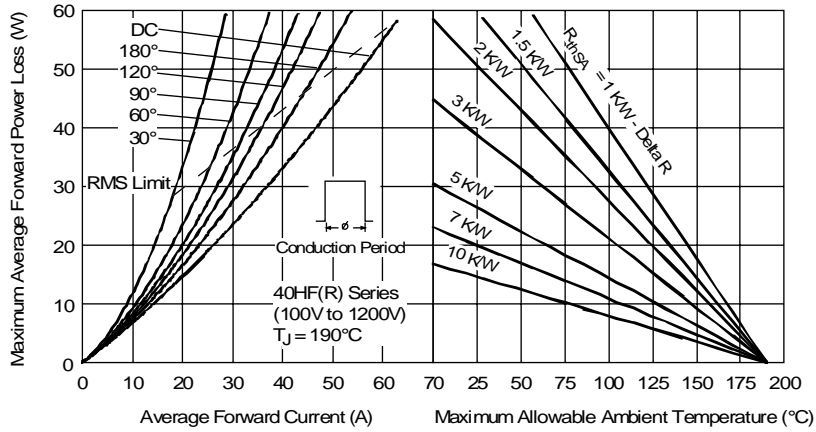

Fig. 6 - Forward Power Loss Characteristics

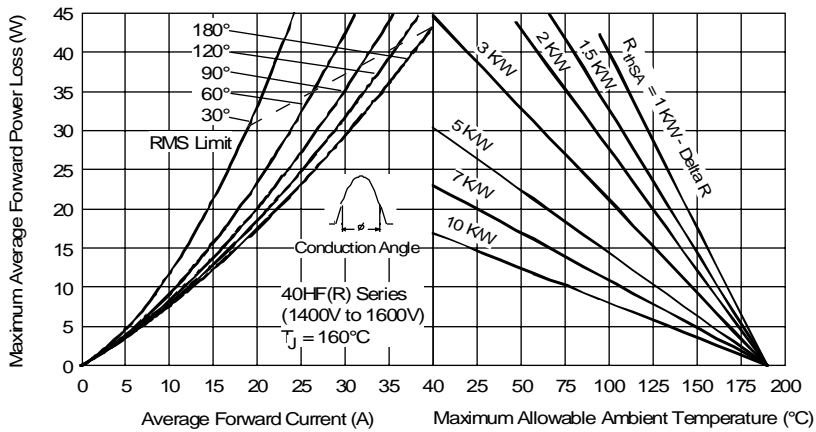

Fig. 7 - Forward Power Loss Characteristics

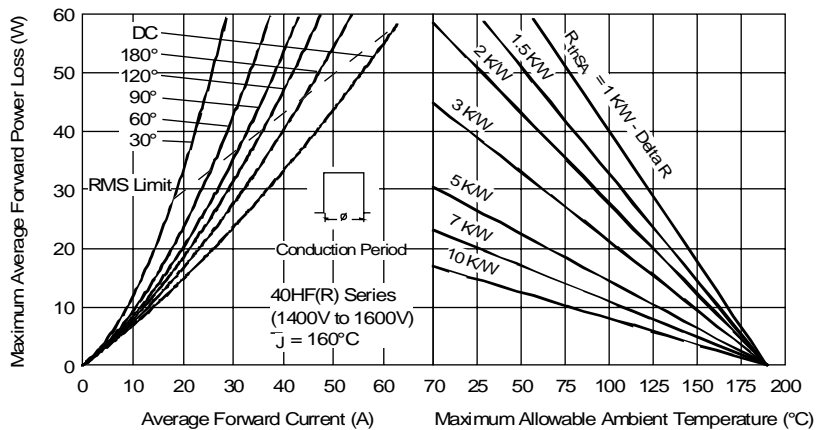

Fig. 8 - Forward Power Loss Characteristics

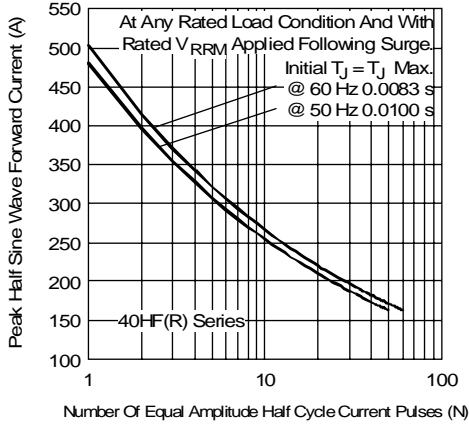

Fig. 9 - Maximum Non-Repetitive Surge Current

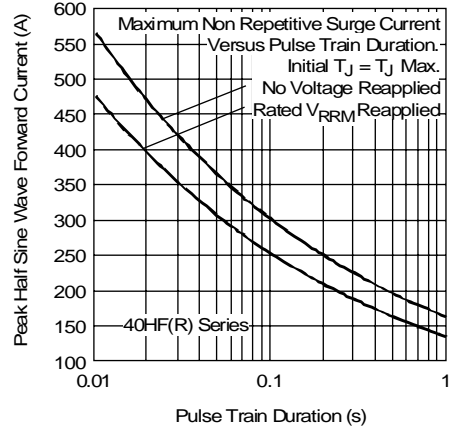

Fig. 10 - Maximum Non-Repetitive Surge Current

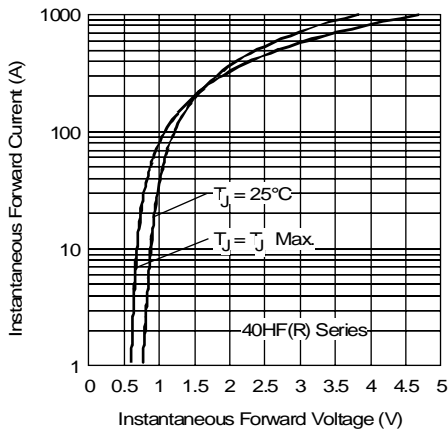

Fig. 11 - Forward Voltage Drop Characteristics

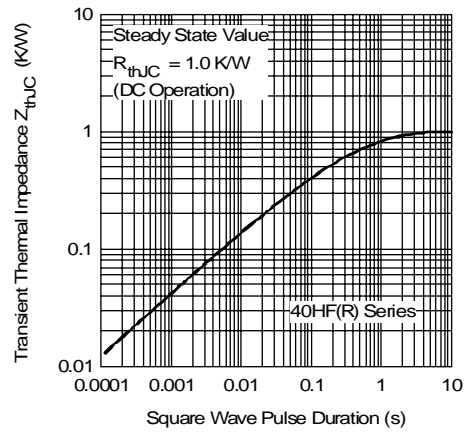

Fig. 12 - Thermal Impedance Z_{thJC} Characteristics