



54ACT/74ACT323

8-Bit Universal Shift/Storage Register

with Synchronous Reset and Common I/O Pins

General Description

The 'ACT323 is an 8-bit universal shift/storage register with TRI-STATE® outputs. Parallel load inputs and flip-flop outputs are multiplexed to minimize pin count. Separate serial inputs and outputs are provided for Q₀ and Q₇ to allow easy cascading. Four operation modes are possible: hold (store), shift left, shift right and parallel load.

Features

- Common parallel I/O for reduced pin count
- Additional serial inputs and outputs for expansion
- Four operating modes: shift left, shift right, load and store
- TRI-STATE outputs for bus-oriented applications
- Outputs source/sink 24 mA
- TTL-compatible inputs

Ordering Code: See Section 8

Logic Symbols

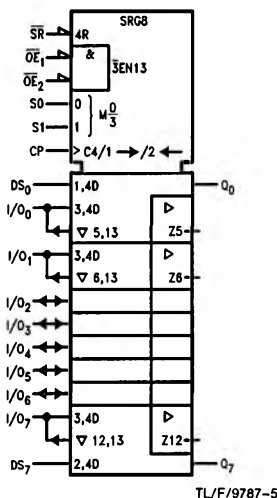
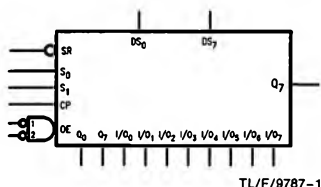

Connection Diagrams

Pin Assignment for DIP, SOIC and Flatpak

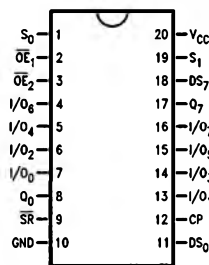

Pin Assignment for LCC

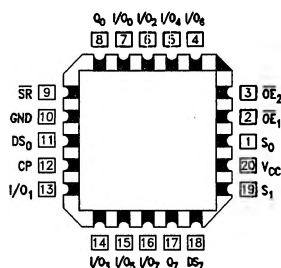

Pin Name	Description
CP	Clock Pulse Input
DS ₀	Serial Data Input for Right Shift
DS ₇	Serial Data Input for Left Shift
S ₀ , S ₁	Mode Select Inputs
SR	Synchronous Reset Input
OE ₁ , OE ₂	TRI-STATE Output Enable Inputs
I/O ₀ -I/O ₇	Multiplexed Parallel Data Inputs or TRI-STATE Parallel Data Outputs
Q ₀ , Q ₇	Serial Outputs

Functional Description





The 'ACT323 contains eight edge-triggered D-type flip-flops and the interstage logic necessary to perform synchronous reset, shift left, shift right, parallel load and hold operations. The type of operation is determined by S_0 and S_1 as shown in the Mode Select Table. All flip-flop outputs are brought out through TRI-STATE buffers to separate I/O pins that also serve as data inputs in the parallel load mode. Q_0 and Q_7 are also brought out on other pins for expansion in serial shifting of longer words.

A LOW signal on \overline{SR} overrides the Select inputs and allows the flip-flops to be reset by the next rising edge of CP.

All other state changes are also initiated by the LOW-to-HIGH CP transition. Inputs can change when the clock is in either state provided only that the recommended setup and hold times, relative to the rising edge of CP, are observed.

A HIGH signal on either \overline{OE}_1 or \overline{OE}_2 disables the TRI-STATE buffers and puts the I/O pins in the high impedance state. In this condition the shift, load, hold and reset operations can still occur. The TRI-STATE buffers are also disabled by HIGH signals on both S_0 and S_1 in preparation for a parallel load operation.

Mode Select Table

Inputs				Response
\overline{SR}	S_1	S_0	CP	
L	X	X		Synchronous Reset; $Q_0-Q_7 = \text{LOW}$
H	H	H		Parallel Load; $I/O_n \rightarrow Q_n$
H	L	H		Shift Right; $DS_0 \rightarrow Q_0, Q_0 \rightarrow Q_1, \text{etc.}$
H	H	L		Shift Left; $DS_7 \rightarrow Q_7, Q_7 \rightarrow Q_6, \text{etc.}$
H	L	L	X	Hold

H = HIGH Voltage Level

L = LOW Voltage Level

X = Immaterial

 = LOW-to-HIGH Clock Transition

Logic Diagram

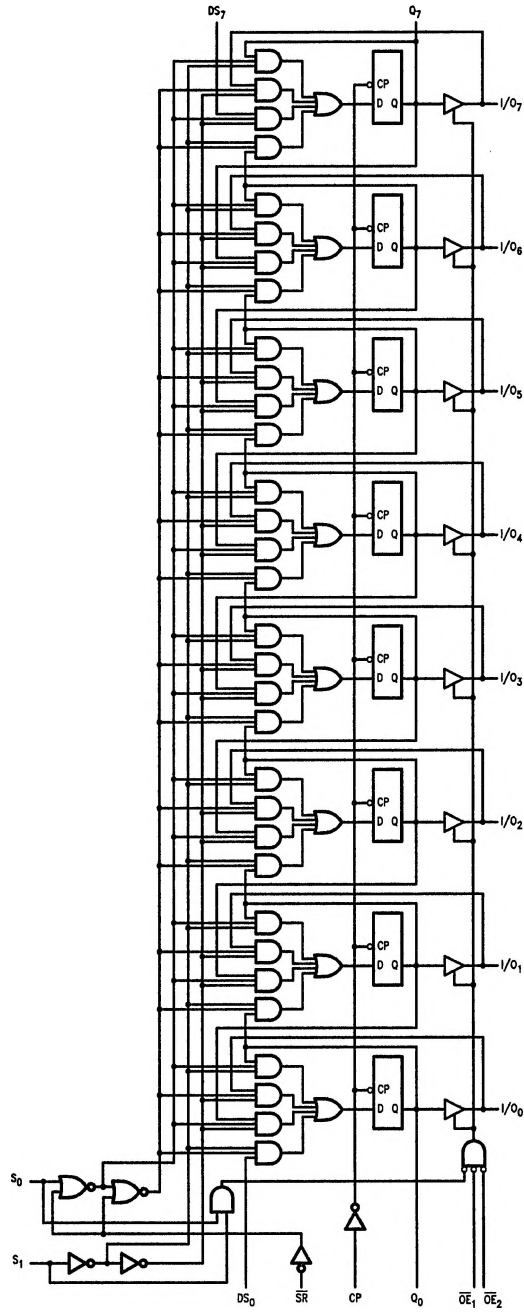

TL/F/9787-4

Please note that this diagram is provided only for the understanding of logic operations and should not be used to estimate propagation delays.

Absolute Maximum Ratings (Note 1)

If Military/Aerospace specified devices are required, please contact the National Semiconductor Sales Office/Distributors for availability and specifications.

Supply Voltage (V _{CC})	-0.5V to +7.0V
DC Input Diode Current (I _{IK})	
V _I = -0.5V	-20 mA
V _I = V _{CC} + 0.5V	+20 mA
DC Input Voltage (V _I)	-0.5V to V _{CC} + 0.5V
DC Output Diode Current (I _{OK})	
V _O = -0.5V	-20 mA
V _O = V _{CC} + 0.5V	+20 mA
DC Output Voltage (V _O)	-0.5V to V _{CC} + 0.5V
DC Output Source or Sink Current (I _O)	±50 mA
DC V _{CC} or Ground Current Per Output Pin (I _{CC} or I _{GND})	±50 mA
Storage Temperature (T _{STG})	-65°C to +150°C
Junction Temperature (T _J)	
CDIP	175°C
PDIP	140°C

Note 1: Absolute maximum ratings are those values beyond which damage to the device may occur. The databook specifications should be met, without exception, to ensure that the system design is reliable over its power supply, temperature, and output/input loading variables. National does not recommend operation of FACT™ circuits outside databook specifications.

Recommended Operating Conditions

Supply Voltage (V _{CC})	
'AC	2.0V to 6.0V
'ACT	4.5V to 5.5V
Input Voltage (V _I)	0V to V _{CC}
Output Voltage (V _O)	0V to V _{CC}
Operating Temperature (T _A)	
74AC/ACT	-40°C to +85°C
54AC/ACT	-55°C to +125°C
Minimum Input Edge Rate (ΔV/Δt)	
'AC Devices	
V _{IN} from 30% to 70% of V _{CC}	
V _{CC} @ 3.3V, 4.5V, 5.5V	125 mV/ns
Minimum Input Edge Rate (ΔV/Δt)	
'ACT Devices	
V _{IN} from 0.8V to 2.0V	
V _{CC} @ 4.5V, 5.5V	125 mV/ns

DC Electrical Characteristics For 'ACT Family Devices

Symbol	Parameter	V _{CC} (V)	74ACT			54ACT		74ACT		Units	Conditions
			T _A = +25°C			T _A = -55°C to +125°C		T _A = -40°C to +85°C			
			Typ	Guaranteed Limits							
V _{IH}	Minimum High Level Input Voltage	4.5	1.5	2.0	2.0	2.0	2.0	2.0	V	V _{OUT} = 0.1V or V _{CC} - 0.1V	
		5.5	1.5	2.0	2.0	2.0	2.0				
V _{IL}	Maximum Low Level Input Voltage	4.5	1.5	0.8	0.8	0.8	0.8	0.8	V	V _{OUT} = 0.1V or V _{CC} - 0.1V	
		5.5	1.5	0.8	0.8	0.8	0.8				
V _{OH}	Minimum High Level Output Voltage	4.5	4.49	4.4	4.4	4.4	4.4	4.4	V	I _{OUT} = -50 μA	
		5.5	5.49	5.4	5.4	5.4	5.4				
		4.5		3.86	3.70	3.76		V	*V _{IN} = V _{IL} or V _{IH} I _{OH} = -24 mA -24 mA		
		5.5		4.86	4.70	4.76					
V _{OL}	Maximum Low Level Output Voltage	4.5	0.001	0.1	0.1	0.1	0.1	0.1	V	I _{OUT} = 50 μA	
		5.5	0.001	0.1	0.1	0.1	0.1				
		4.5		0.36	0.50	0.44		V	*V _{IN} = V _{IL} or V _{IH} I _{OL} = -24 mA -24 mA		
		5.5		0.36	0.50	0.44					
I _{IN}	Maximum Input Leakage Current	5.5		±0.1	±1.0		±1.0	μA	V _I = V _{CC} , GND		
I _{OZ}	Maximum TRI-STATE Current	5.5		±0.5	±10.0		±5.0	μA	V _I = V _{IL} , V _{IH} V _O = V _{CC} , GND		
I _{OZT}	Maximum I/O Leakage Current	5.5		±0.6	±11.0		±6.0	μA	V _{I/O} = V _{CC} or GND V _{IN} = V _{IH} , V _{IL}		
I _{CC1}	Maximum I _{CC} /Input	5.5	0.6		1.6		1.5	mA	V _I = V _{CC} - 2.1V		
I _{OLD}	†Minimum Dynamic Output Current	5.5			50		75	mA	V _{OLD} = 1.65V Max		
		5.5			-50		-75	mA	V _{OHD} = 3.85V Min		
I _{CC}	Maximum Quiescent Supply Current	5.5		8.0	160		80	μA	V _{IN} = V _{CC} or GND		

*All outputs loaded; thresholds on input associated with output under test.

†Maximum test duration 2.0 ms, one output loaded at a time.

Note: I_{CC} for 54ACT is identical to 74ACT @ 25°C.

AC Electrical Characteristics: See Section 2 for Waveforms

Symbol	Parameter	V _{CC} * (V)	74ACT			54ACT		74ACT		Units	Fig. No.
			T _A = 25°C C _L = 50 pF			T _A = -55°C to +125°C C _L = 50 pF		T _A = -40°C to +85°C C _L = 50 pF			
			Min	Typ	Max	Min	Max	Min	Max		
f _{max}	Maximum Input Frequency	5.0	120	125		95		110	MHz		
t _{PLH}	Propagation Delay CP to Q ₀ or Q ₇	5.0	5.0	9.0	12.5	1.0	16.5	4.0	14.0	ns	2-3, 4
t _{PHL}	Propagation Delay CP to Q ₀ or Q ₇	5.0	5.0	9.0	13.5	1.0	17.0	4.5	15.0	ns	2-3, 4
t _{PLH}	Propagation Delay CP to I/O _n	5.0	5.0	8.5	12.5	1.0	16.5	4.5	14.5	ns	2-3, 4
t _{PHL}	Propagation Delay CP to I/O _n	5.0	6.0	10.0	14.5	1.0	18.0	5.0	16.0	ns	2-3, 4
t _{pZH}	Output Enable Time	5.0	3.5	7.5	11.0	1.0	15.0	3.0	12.5	ns	2-5
t _{pZL}	Output Enable Time	5.0	3.5	7.5	11.5	1.0	15.5	3.0	13.0	ns	2-6
t _{pHZ}	Output Disable Time	5.0	4.0	8.5	12.5	1.0	15.5	3.0	13.5	ns	2-5
t _{pLZ}	Output Disable Time	5.0	3.0	8.0	11.5	1.0	15.0	2.5	12.5	ns	2-6

*Voltage Range 5.0 is 5.0V ±0.5V

AC Operating Requirements: See Section 2 for Waveforms

Symbol	Parameter	V _{CC} * (V)	74ACT		54ACT		74ACT		Units	Fig. No.
			T _A = 25°C C _L = 50 pF V _{CC} = +5.0V		T _A = -55°C to +125°C C _L = 50 pF V _{CC} = +5.0V		T _A = -40°C to +85°C C _L = 50 pF V _{CC} = +5.0V			
			Typ	Guaranteed Minimum						
t _s	Setup Time, HIGH or LOW S ₀ or S ₁ to CP	5.0	2.0	5.0		6.0		5.0	ns	2-7
t _h	Hold Time, HIGH or LOW S ₀ or S ₁ to CP	5.0	0	1.5		1.5		1.5	ns	2-7
t _s	Setup Time, HIGH or LOW I/O _n , DS ₀ , DS ₇ to CP	5.0	1.0	4.0		4.5		4.5	ns	2-7
t _h	Hold Time, HIGH or LOW I/O _n , DS ₀ , DS ₇ to CP	5.0	0	1.0		1.0		1.0	ns	2-7
t _s	Setup Time, HIGH or LOW SR to CP	5.0	1.0	2.5		3.0		2.5	ns	2-7
t _h	Hold Time, HIGH or LOW SR to CP	5.0	0	1.0		1.0		1.0	ns	2-7
t _w	CP Pulse Width HIGH or LOW	5.0	2.0	4.0		5.0		4.5	ns	2-3

*Voltage Range 5.0 is 5.0V ±0.5V

Capacitance

Symbol	Parameter	Typ	Units	Conditions
C _{IN}	Input Capacitance	4.5	pF	V _{CC} = 5.0V
C _{PD}	Power Dissipation Capacitance	170	pF	V _{CC} = 5.0V