

AN96A07K

Dynamic Focus Controller IC for CRT Monitor

■ Overview

The AN96A07K is a dynamic astigmatism and focus (DAF)IC for CRT monitor. It outputs parabola waves for focus control.

■ Features

- $f_H = 15$ to 90kHz, $f_V = 50$ to 120Hz
- Constant-amplitude parabola-wave output following input frequency
- Coefficient of parabola-wave is controlled by an external resistor

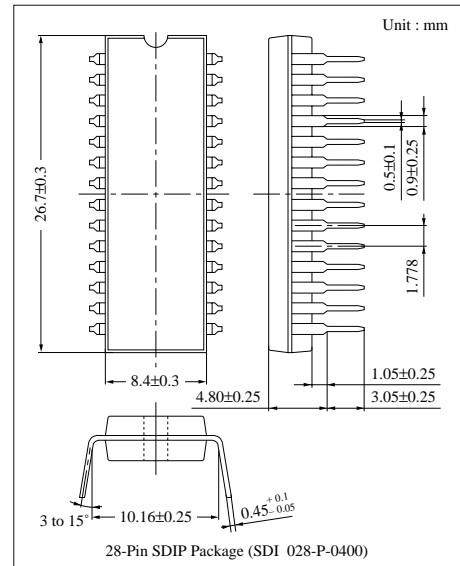

■ Block Diagram

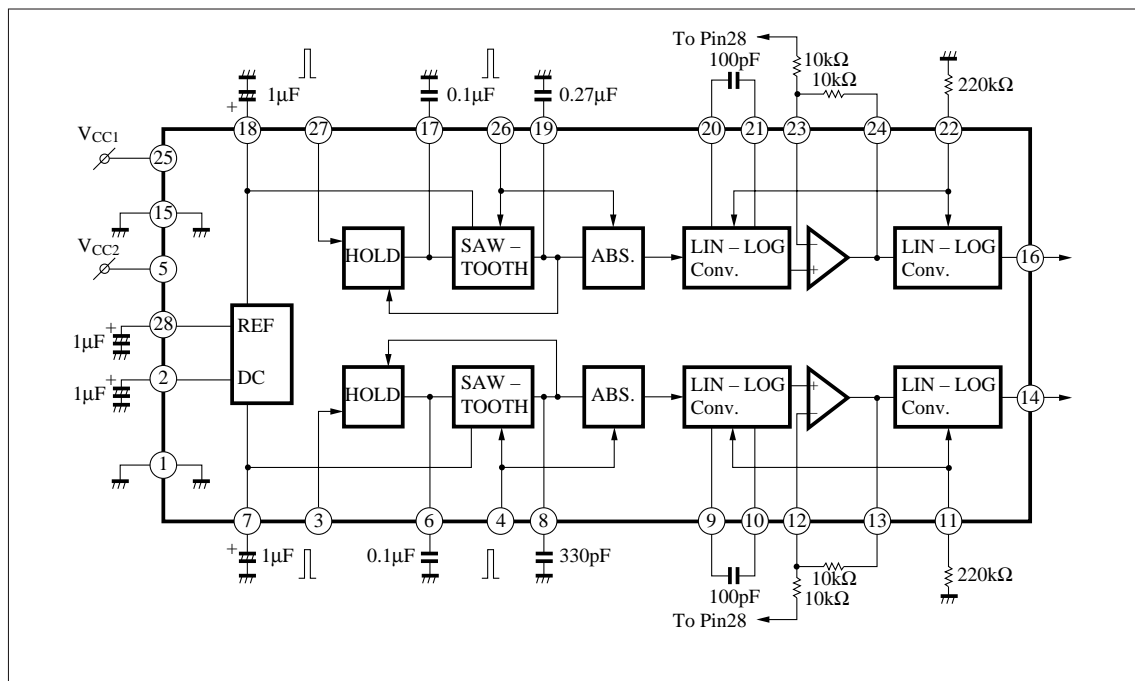

■ Pin Descriptions

Pin No.	Pin name	Pin No.	Pin name
1	GND	15	GND
2	Reference bias output (6V)	16	Ver. parabola output
3	Hor. sampling pulse input	17	Holding
4	Hor. phase shift pulse input	18	Ver. system reference bias output (2V)
5	V _{CC1} (12V)	19	Triangular waveform generation capacitor
6	Holding	20	Oscillation prevention capacitor
7	Hor. system reference bias output (2V)	21	Oscillation prevention capacitor
8	Triangular waveform generation capacitor	22	Ver. parabola output amplitude adj.
9	Oscillation prevention capacitor	23	Feedback input
10	Oscillation prevention capacitor	24	Feedback output
11	Hor. parabola output amplitude adj.	25	V _{CC2} (12V)
12	Feedback input	26	Ver. phase shift pulse input
13	Feedback output	27	Ver. sampling pulse input
14	Hor. parabola output	28	Reference bias output (4V)

■ Absolute Maximum Ratings

Parameter	Symbol	Rating	Unit
Supply voltage	V _{CC}	13.4	V
Supply current	I _{CC}	30	mA
Power dissipation ^{Note 2)}	P _D	402	mW
Operating ambient temperature ^{Note 1)}	T _{opr}	- 20 to + 75	°C
Storage temperature ^{Note 1)}	T _{stg}	- 55 to + 150	°C

Note 1) Ta= 25°C except operating ambient temperature and storage temperature.

Note 2) Allowable power dissipation of the package at Ta=75°C.

■ Recommended Operating Range (Ta= 25°C)

Parameter	Symbol	Range
Operating supply voltage range	V _{CC}	9.6V to 13.2V

■ Electrical Characteristics (Ta=25±2°C)

Parameter	Symbol	Condition	min	typ	max	Unit	
Circuit current	I _{CC}	See table 1	14	19	24	mA	
Circuit voltage	V _{2-1.15}		5.7	6.2	6.7	V	
Circuit voltage	V _{28-1.15}		3.7	4.2	4.7	V	
Circuit voltage	V _{7-1.15}		1.4	1.9	2.4	V	
Circuit voltage	V _{18-1.15}		1.4	1.9	2.4	V	
Hold charging current (1)	I _{6(C)}		-450	-370	-290	μA	
Hold charging current (2)	I _{17(C)}		-450	-370	-290	μA	
Hold discharging current (1)	I _{6(D)}		290	370	450	μA	
Hold discharging current (2)	I _{17(D)}		290	370	450	μA	
Hold leak voltage (1)	I _{6(L)}		-1.0	—	+1.0	μA	
Hold leak voltage (2)	I _{17(L)}		-1.0	—	+1.0	μA	
Triangular wave output voltage (1)	V ₈₋₇		—	—	0.2	V	
Triangular wave output voltage (2)	V ₁₉₋₁₈		—	—	0.2	V	
Triangular wave charging current (1)	I _{8(C1)}		-28	-20	-12	μA	
Triangular wave charging current (2)	I _{19(C1)}		-28	-20	-12	μA	
Triangular wave charging current (3)	I _{8(C2)}		-165	-135	-105	μA	
Triangular wave charging current (4)	I _{19(C2)}		-165	-135	-105	μA	
Triangular wave linearity (1)	ΔI _{8(R)}		-3	0	+3	μA	
Triangular wave linearity (2)	ΔI _{19(R)}		-3	0	+3	μA	
Triangular wave discharging current (1)	I _{8(D)}		7.0	8.5	9.5	mA	
Triangular wave discharging current (2)	I _{19(D)}		7.0	8.5	9.5	mA	
Parabola output voltage (1)	V ₁₄₍₁₎		3.7	4.2	4.7	V	
Parabola output voltage (2)	V ₁₄₍₂₎		8.0	9.5	11.0	V	
Parabola output voltage (3)	ΔV ₁₄₍₃₎		-0.3	0	+0.3	V	
Parabola output voltage (4)	ΔV ₁₄₍₄₎		-4.5	-3.5	-2.5	V	
Parabola output voltage (5)	V ₁₆₍₅₎		3.7	4.2	4.7	V	
Parabola output voltage (6)	V ₁₆₍₆₎		8.0	9.5	11.0	V	
Parabola output voltage (7)	ΔV ₁₆₍₇₎		-0.3	0	+0.3	V	
Parabola output voltage (8)	ΔV ₁₆₍₈₎		-4.5	-3.5	-2.5	V	
Clamp output voltage (1)	V _{14(CL)}		10.2	10.7	11.2	V	
Clamp output voltage (2)	V _{16(CL)}		10.2	10.7	11.2	V	
Horizontal operation frequency (max.)	f _{H(max.)}		Operable upper limit frequency	—	(100)	—	kHz
Vertical operation frequency (max.)	f _{V(max.)}		Operable upper limit frequency	—	(150)	—	Hz
Horizontal triangular wave output amplitude	e ₁		f _H =15 to 90kHz	—	(4)	—	V _{P-P}
Vertical triangular wave output amplitude	e ₂		f _V = 50 to 120Hz	—	(4)	—	V _{P-P}
Horizontal parabola wave output amplitude	e ₃		f _H = 64kHz I ₁₁ = -20μA	—	(4)	—	V _{P-P}
Vertical parabola wave output amplitude	e ₄		f _V = 90Hz I ₂₂ = -20μA	—	(4)	—	V _{P-P}
Parabola wave exponential coefficient (horizontal)	α _H		10kΩ between Pin12 to 13 10kΩ between Pin12 to 28	—	(2)	—	—
Parabola wave exponential coefficient (vertical)	α _V		10kΩ between Pin23 to 24 10kΩ between Pin23 to 28	—	(2)	—	—

Note) The value in the above characteristics is not a guaranteed value, but reference one on design.

Table 1 (cont.)

No.	Parameter	Symbol	Measure- ment pin No.	Pin No.																														
				1	2	3	4	5	6	7	8	9	10	11	12	13	14	15	16	17	18	19	20	21	22	23	24	25	26	27	28			
20	Triangle waveform discharging current (1)	$I_{8(D)}$	8	0V		0V	2.5V	12V	6V	180Ω to 1	6V					0V		6V		6V								to 5	to 4	to 3				
21	Triangle waveform discharging current (2)	$I_{19(D)}$	19	0V		0V	2.5V	12V	6V		6V					0V		6V	180Ω to 1	6V								to 5	to 4	to 3				
22	Parabola output voltage (1)	$V_{14(1)}$	14	0V		0V	0V	12V	0V		0μA			-20μA	10k to 28	10k to 12		0V		0V								to 5	0V	0V	20k to 8			
23	Parabola output voltage (2)	$V_{14(2)}$	14	0V		0V	0V	12V	0V		100μA			-20μA	10k to 28	10k to 12		0V		0V								to 5	0V	0V	20k to 8			
24	Parabola output voltage (3)	$\Delta V_{14(3)}$	14	0V		0V	0V	12V	0V		100μA ↓ -100 μA			-20μA	10k to 28	10k to 12		0V		0V								to 5	0V	0V	20k to 8			
25	Parabola output voltage (4)	$\Delta V_{14(4)}$	14	0V		0V	0V	12V	0V		100μA			-20μA ↓ -150 μA		10k to 12		0V		0V								to 5	0V	0V	20k to 8			
26	Parabola output voltage (5)	$V_{16(5)}$	16	0V		0V	0V	12V	0V									0V		0V				0μA			-20μA	10k to 28	10k to 23	to 5	0V	0V	20k to 19	
27	Parabola output voltage (6)	$V_{16(6)}$	16	0V		0V	0V	12V	0V									0V		0V				100μA			-20μA	10k to 28	10k to 23	to 5	0V	0V	20k to 19	
28	Parabola output voltage (7)	$\Delta V_{16(7)}$	16	0V		0V	0V	12V	0V									0V		0V				100μA ↓ -100 μA			-20μA	10k to 28	10k to 23	to 5	0V	0V	20k to 19	
29	Parabola output voltage (8)	$\Delta V_{16(8)}$	16	0V		0V	0V	12V	0V									0V		0V				100μA			-20μA ↓ -150 μA	10k to 28	10k to 23	to 5	0V	0V	20k to 19	
30	Clamp output voltage (1)	$V_{14(CL)}$	14	0V		0V	2.5V	12V	0V		0μA				-20μA	10k to 28	10k to 12		0V		0V								to 5	to 4	0V	20k to 8		
31	Clamp output voltage (2)	$V_{16(CL)}$	16	0V		0V	2.5V	12V	0V									0V		0V				0μA				-20μA	10k to 28	10k to 23	to 5	to 4	0V	20k to 19



■ Pin Descriptions

Pin No.	Pin name	Waveform	Equivalent circuit	Function
1	GND	0V		GND for horizontal system
2	Reference bias output (6V)	DC (6.0V)		Reference bias output (6V)
3	Hor. sampling pulse input			Input of sampling pulse (0.1 to 0.2μs) for detecting triangular waveform amplitude
4	Hor. phase shift pulse input			Pulse input (0.5 to 2μs) for discharging triangular waveform voltage
5	V _{CC1} (12V)	12V		Power supply for horizontal system
6	Holding			Determines the charging current of triangular waveform. Dynamically variable with f_M .
7	Hor. system reference bias output (2V)	DC (2.0V)		Reference bias for horizontal system (2V)
8	Triangular waveform generation capacitor			Triangular waveform generation capacitor The discharging current of triangular waveform sinks into the 2V-reference-voltage source (Pin7).

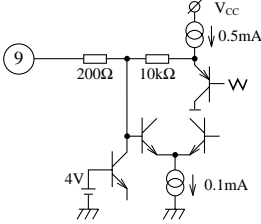
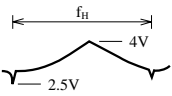
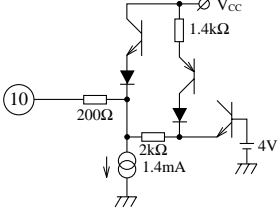
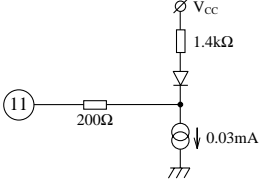
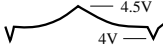
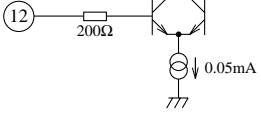
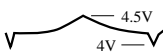
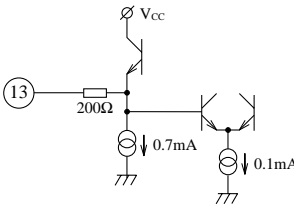
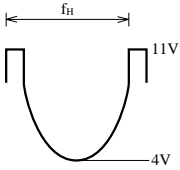
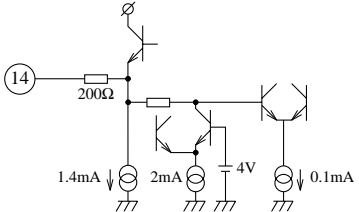
■ Pin Descriptions (cont.)

Pin No.	Pin name	Waveform	Equivalent circuit	Function
9	Oscillation prevention capacitor			Oscillation prevention capacitor If the parabola output oscillates, a capacitor of several 10pF must be connected between this pin and Pin10.
10	Oscillation prevention capacitor			Oscillation prevention capacitor If the parabola output oscillates, capacitor of several 10 pF must be connected between this pin and Pin9.
11	Hor. parabola output amplitude adjustment	DC (11.2V)		Control pin of the amplitude of horizontal parabola output. If the current is increased by inserting a resistor between this pin and GND, the amplitude decrease.
12	Feedback input			Feedback input for gain adjustment
13	Feedback output			Feedback output-pin for gain adjustment The gain is set by a resistor which is connected between Pins12 and 28.
14	Hor. parabola output			Output of horizontal parabola waveform
15	GND	0V		GND for vertical system

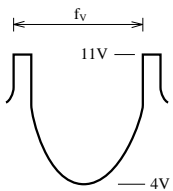
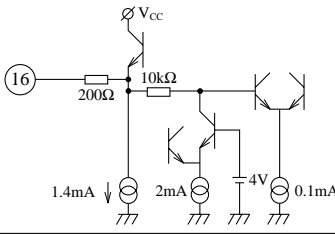
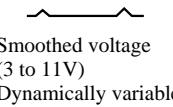
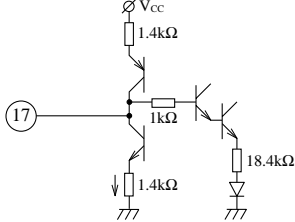
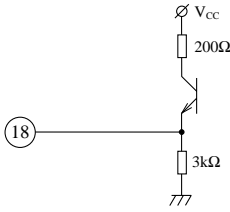
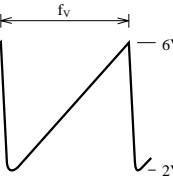
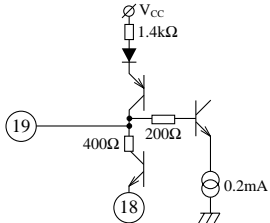
■ Pin Descriptions (cont.)

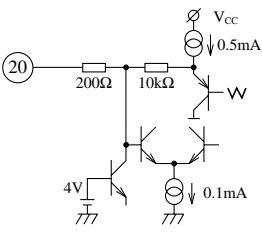
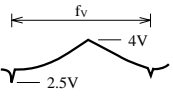
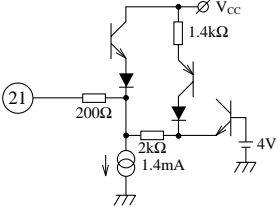
Pin No.	Pin name	Waveform	Equivalent circuit	Function
16	Ver. parabola output			Output of vertical parabola waveform
17	Holding	 Smoothed voltage (3 to 11V) Dynamically variable		Control pin of the charging current of vertical-system triangular-waveform Dynamically changable with f_v .
18	Ver. system reference bias output	DC (2.0V)		Reference bias of vertical system (2V)
19	Triangular generation capacitor			Triangular waveform-generation capacitor The discharging current of triangular waveform sinks into the 2V reference voltage source (Pin18).
20	Oscillation prevention capacitor			Oscillation-prevention capacitor If the parabola output oscillates, a capacitor of several 10pF must be connected between this pin and Pin21.
21	Oscillation prevention capacitor			Oscillation-prevention capacitor If the parabola output oscillates, a capacitor of several 10pF must be connected between this pin and Pin20.

■ Pin Descriptions (cont.)

Pin No.	Pin name	Waveform	Equivalent circuit	Function
22	Ver. parabola output amplitude adj.	DC (11.2V)		Control pin of the amplitude of vertical parabola output When the current is increased by inserting a resistor between this pin and GND, the amplitude decrease.
23	Feedback input			Feedback input for gain adjustment
24	Feedback output			Feedback output for gain adjustment The gain is set by the value of a resistor which is connected between Pins23 and 28.
25	V _{CC2} (12V)	12V		Ver. system power supply
26	Ver. phase shift pulse input			Pulse (200 to 700μs) input for discharging triangular waveform
27	Ver. Sampling pulse input			Input of sampling pulse (50 to 80μs) which detects the amplitude of triangular waveform
28	Reference bias output (4V)	DC (4.0V)		Output for reference bias (4V)

