

2-channel PRE/REC amplifier with auto-tracking interface

BA7182AS

The BA7182AS is a PRE/REC amplifier developed for use in video cassette recorders. It has been designed for use in two-head decks and features built-in FB damping, two preamplifiers, a chroma output amplifier, an FM output amplifier (with AGC), an envelope detector, a constant-current BTL-drive REC amplifier (with AGC) and built-in channel and REC/PB switches on a single monolithic IC.

●Applications

VCRs

●Features

- 1) The playback amplifier has a total gain of 59dB (Typ.), and has a low-noise preamplifier. Designed for VHS-band operation with low external parts count. The IC has 2 circuits for 2-head VCR applications.
- 2) Two playback output systems (through output and AGC output). The AGC output level is 270mV_{P-P} (Typ.); suitable for FM brightness signal output.
- 3) Auto-tracking interface for automated tracking adjustment. An integrate and hold detector is used to reduce the load on the microcontroller.
- 4) The recording amplifier uses constant-current BLT drive that handles load variations (i.e. head impedance) well, and gives stable recording characteristics. A single circuit is provided for 2-head VCR use.
- 5) Built-in recording level AGC means adjustment of FM recording current is not necessary.
- 6) Head switches for 2-channel PRE/REC system provided.
- 7) Operates off a single 5V power supply, with low power dissipation.

●Absolute maximum ratings (Ta=25°C)

Parameter	Symbol	Limits	Unit
Applied voltage	V _{CC}	7.0	V
Power dissipation	P _d	1100 *	mW
Operating temperature	T _{opr}	-20~75	°C
Storage temperature	T _{stg}	-55~125	°C

* Reduced by 11mW for each increase in Ta of 1°C over 25°C (free air).

●Recommended operating conditions (Ta=25°C)

Parameter	Symbol	Min.	Typ.	Max.	Unit	Conditions
Playback/recording	V _{CC}	4.5	5.0	5.5	V	12pin

© Not designed for radiation resistance.

●Block diagram

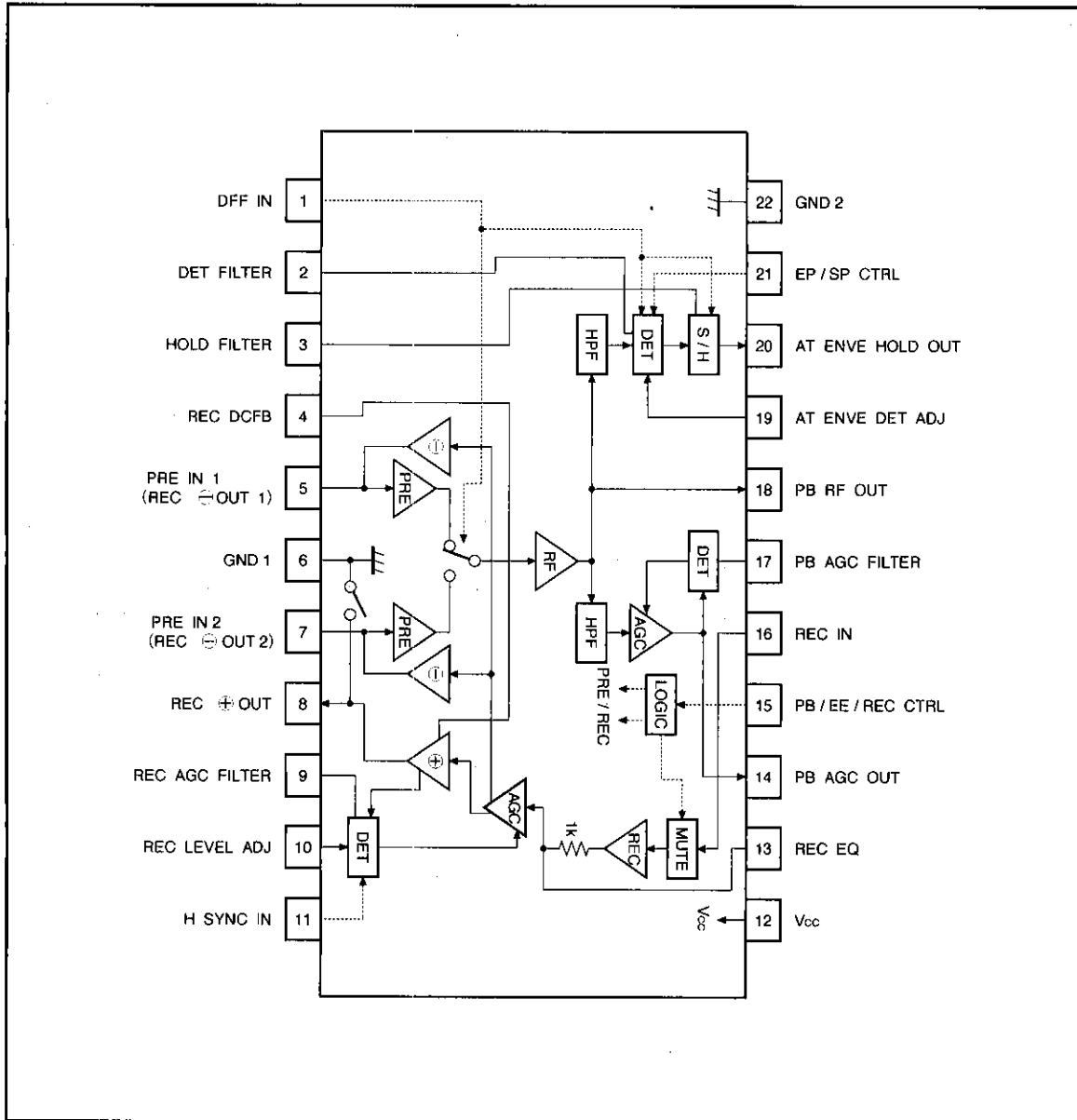

●Electrical characteristics (Unless otherwise specified, Ta=25°C, Vcc=5.0V and f=4.0MHz)

Parameter	Symbol	Min.	Typ.	Max.	Unit	Conditions	Measurement Circuit
(Playback system)						Pin 15: H	
Quiescent current	I_q (P)	—	26	42	mA	No signal	Fig.1
Voltage gain CH-1	G_{VP1}	56.5	59	61.5	dB	Pin 5 input = 0.3mV _{P-P} , pin 1: L, pin 18 output measurement	Fig.1
Voltage gain CH-2	G_{VP2}	56.5	59	61.5	dB	Pin 7 input = 0.3mV _{P-P} , pin 1: H, pin 18 output measurement	Fig.1
Voltage gain differential	ΔG_{VP}	-1	0	1	dB	$\Delta G_{VP} = G_{VP1} - G_{VP2}$	Fig.1
Frequency characteristic	ΔG_{VI}	-6	-3	-1	dB	Difference in pin 18 output level for f = 8.0/1.0MHz, $V_{IN} = 0.3mV_{P-P}$	Fig.1
2nd harmonic distortion	2HDP	—	-45	-35	dBc	$V_{IN} = 0.3mV_{P-P}$, 8.0MHz spurious	Fig.1
3rd harmonic distortion	3HDP	—	-50	-35	dBc	$V_{IN} = 0.3mV_{P-P}$, 12.0MHz spurious, guaranteed design value.	Fig.1
Maximum output level	V_{OMP}	1.0	1.5	—	V _{P-P}	When pin 18 output 2nd harmonic distortion is -30dBc	Fig.1
Crosstalk	CTP	—	-38	-33	dBc	Difference in pin 18 output level for pin 1: H/L.	Fig.1
Output DC offset	ΔV_{ODC}	-150	0	150	mV _{P-P}	Pin 18 output DC offset for pin 1: H/L.	Fig.1
Input conversion noise	V_{NIN}	—	0.25	1.0	μV_{rms}	$R_g = 10\Omega$, input conversion of pin 18 output noise, guaranteed design value.	Fig.1
AGC output level	V_{AGC}	220	270	320	mV _{P-P}	$V_{IN} = 0.3mV_{P-P}$ Pin 14 output measurement	Fig.1
AGC control sensitivity	ΔV_{AGC}	—	0.3	2	dB	Pin 14 output level difference for $V_{IN} = 0.15$ and $0.6mV_{P-P}$	Fig.1
AGC frequency characteristic	ΔG_{VAF}	-2	0.5	2	dB	Difference in pin 14 output level for f = 8.0/1.0MHz $V_{IN} = 0.3mV_{P-P}$.	Fig.1
PB switch ON resistance	R_{ON8}	—	5	10	Ω	Pin 8 impedance	Fig.1
PRE CH 2 threshold voltage	V_{THH}	3.5	—	V_{CC}	V	Pin 1 DC voltage for CH 2 operation	Fig.1
PRE CH 1 threshold voltage	V_{THL}	0	—	1.2	V	Pin 1 DC voltage for CH 1 operation	Fig.1
ENVE output level SP-2	V_{EN-S2}	1.4	2.2	3.0	V	Pin 20 output measurement when pin 21 = L and pin 18 output = 250mV _{P-P}	Fig.1
ENVE sensitivity curve	P_{CRV}	150	200	250	%		Fig.1
ENVE saturation voltage	V_{EN-SA}	4.6	4.9	—	V	Pin 21 = L, Pin 20 output measurement for large signal	Fig.1
ENVE residual voltage	V_{EN-SI}	—	0.1	0.4	V	Pin 21 = L, Pin 20 output measurement for no signal	Fig.1
EP mode threshold voltage	V_{TH2H}	3.5	—	V_{CC}	V	Pin 21 DC voltage for EP mode	Fig.1
SP mode threshold voltage	V_{TH2L}	0	—	1.2	V	Pin 21 DC voltage for SP mode	Fig.1

PRE/REC amplifiers

VCR components

● Electrical characteristics (Unless otherwise specified, $T_a=25^\circ\text{C}$, $V_{CC}=5.0\text{V}$, $f=4.0\text{MHz}$ and $I_{OAR}=36\text{mA}_{P-P}$)

Parameter	Symbol	Min.	Typ.	Max.	Unit	Conditions	Measurement Circuit
(Recording system)						Pin 15: L	
Quiescent current	$I_q (R)$	—	72	108	mA	No signal	Fig.2
Recording AGC level	I_{OAR}	30	36	42	mA_{P-P}	Pin 16 input = 400mV_{P-P} , pin 8 output measurement	Fig.2
AGC control sensitivity	ΔI_{OAR}	—	0.15	2	dB	Pin 8 output level difference for $f = 4.0\text{MHz}$, pin 16 input = 225mV_{P-P} and 800mV_{P-P} .	Fig.2
AGC frequency characteristic	ΔI_{OAF}	-2	0	2	dB	Pin 8 output level difference for $f = 8.0/1.0\text{MHz}$, pin 16 input = 400mV_{P-P}	Fig.2
2nd harmonic distortion	2HDr	—	-41	-35	dBc	Pin 16 input = 400mV_{P-P} , 8.0MHz spurious.	Fig.2
3rd harmonic distortion	3HDr	—	-50	-40	dBc	Pin 16 input = 400mV_{P-P} , 12.0MHz spurious, guaranteed design value.	Fig.2
Cross modulation distortion	CMDr	—	-43	-38	dBc	4.0MHz \pm 630kHz spurious, guaranteed design value.	Fig.2
Maximum output level	I_{OMR}	42	50	—	mA_{P-P}	When pin 8 output 2nd harmonic distortion is -30dB	Fig.2
Recording current load characteristic	ΔI_{ORL}	-2	-0.35	—	dB	Pin 8 output level difference for load L: $8.2 \sim 12 \mu\text{H}$	Fig.2
Mute attenuation ratio	MUR	—	-44	-38	dBc	Pin 8 output level difference for pin 15: M/H.	Fig.2
Frequency characteristic	ΔI_{OEQ}	-5.3	-7.8	-10.3	dB	Pin 8 output level difference for $f = 8.0/1.0\text{MHz}$, AGC OFF	Fig.2
AGC mode threshold voltage	V_{TH1H}	2.7	—	V_{CC}	V	Pin 11 DC voltage to maintain recording AGC operation	Fig.2
AGC mode threshold voltage	V_{TH1L}	0	—	1.2	V	Pin 11 DC voltage to maintain recording AGC stopped	Fig.2
PB mode threshold voltage	V_{TH15H}	3.8	—	V_{CC}	V	Pin 15 DC voltage for PB mode	Fig.2
EE mode threshold voltage	V_{TH15M}	2.2	—	2.8	V	Pin 15 DC voltage for REC MUTE mode	Fig.2
REC mode threshold voltage	V_{TH15L}	0	—	1.2	V	Pin 15 DC voltage for REC mode	Fig.2

* Note: dBc: dB below carrier (used to express relative level from carrier reference for convenience sake)

● Measurement circuit
Playback system

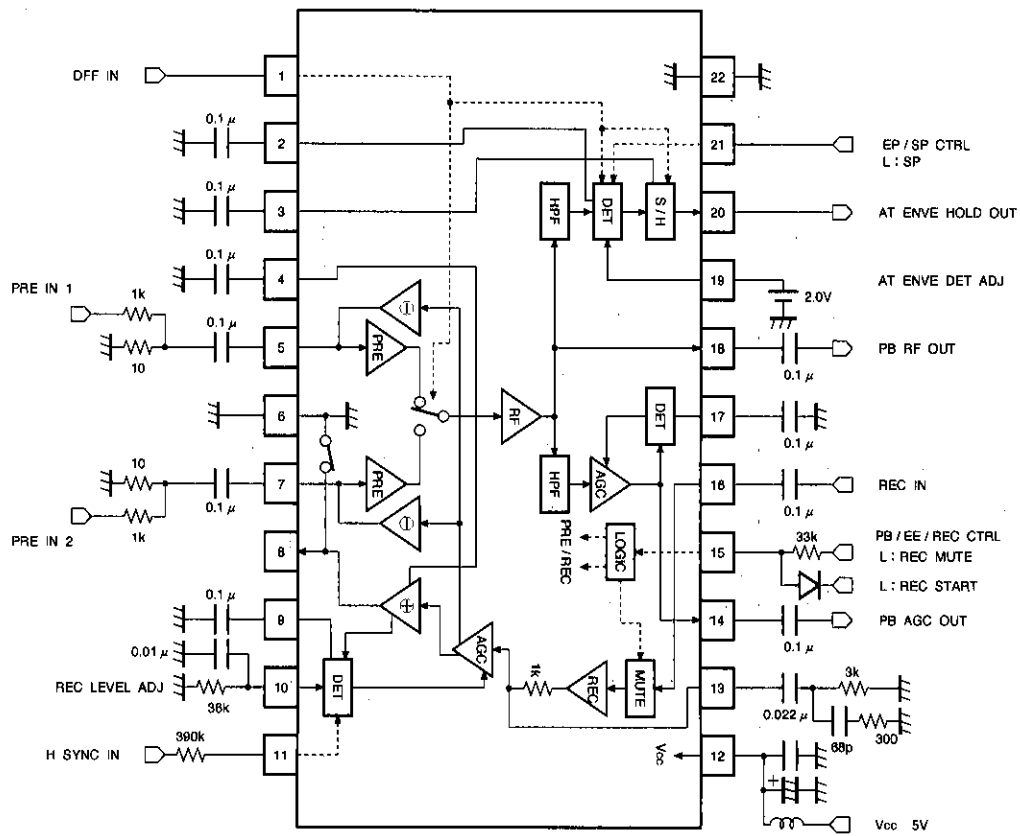

Unit : R [Ω]
C [F]
L [H]

Fig.1

VCR components



PRE/REC amplifiers

Recording system

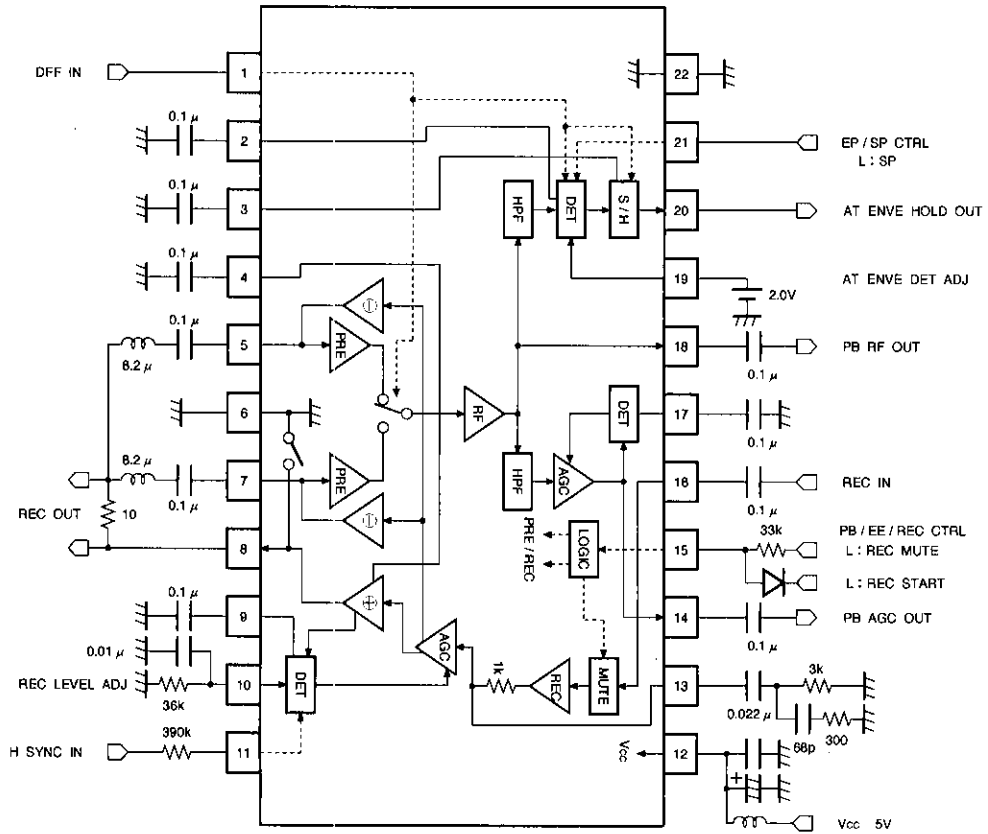

Fig.2

● Control mode table

(1) DFF IN (pin1)

- Playback input selection (head switching)
- Playback output envelope detection timing control (integrate and hold one frame)

Control pin	Function		Control voltage V _{CTRL1} [V]
DFF IN	Selected playback input	Envelope detect	
H	CH2 (PRE IN2 7pin)	Reset on rising edge	3.5 ~ V _{CC}
L	CH1 (PRE IN1 5pin)	—	0.0 ~ 1.2

(2) H SYNC IN (pin11)

- Controls recording AGC detector block operation.

Control pin	Function	Control voltage V _{CTRL11} [V]
H SYNC	AGC detect	
H	ON	2.7 ~ V _{CC}
L	OFF	0.0 ~ 1.2

(3) PB/EE/REC CTRL (pin15)

- Playback/recording mute/recording mode switching

Control pin	Mode	Function				Control voltage V _{CTRL15} [V]
		PRE AMP	AT ENVE	REC MUTE	REC AMP	
H	PB	ON	ON	OFF	OFF	3.8 ~ V _{CC}
M	REC MUTE	OFF	OFF	ON	ON	2.2 ~ 2.8
L	REC	OFF	OFF	OFF	ON	0.0 ~ 1.2

• Pin 15 is pulled up to V_{CC} via a 33kΩ resistor.

(4) EP/SP CTRL (pin21)

- Switching for the detector gain of the playback envelope detector

Control pin	Function	Control voltage V _{CTRL21} [V]
EP / SP	AT ENVE gain	
H	Typ. +6dB	3.5 ~ V _{CC}
L	Typ.	0.0 ~ 1.2

• Pin 21 is pulled up to V_{CC} via a 50kΩ resistor.

●Application example

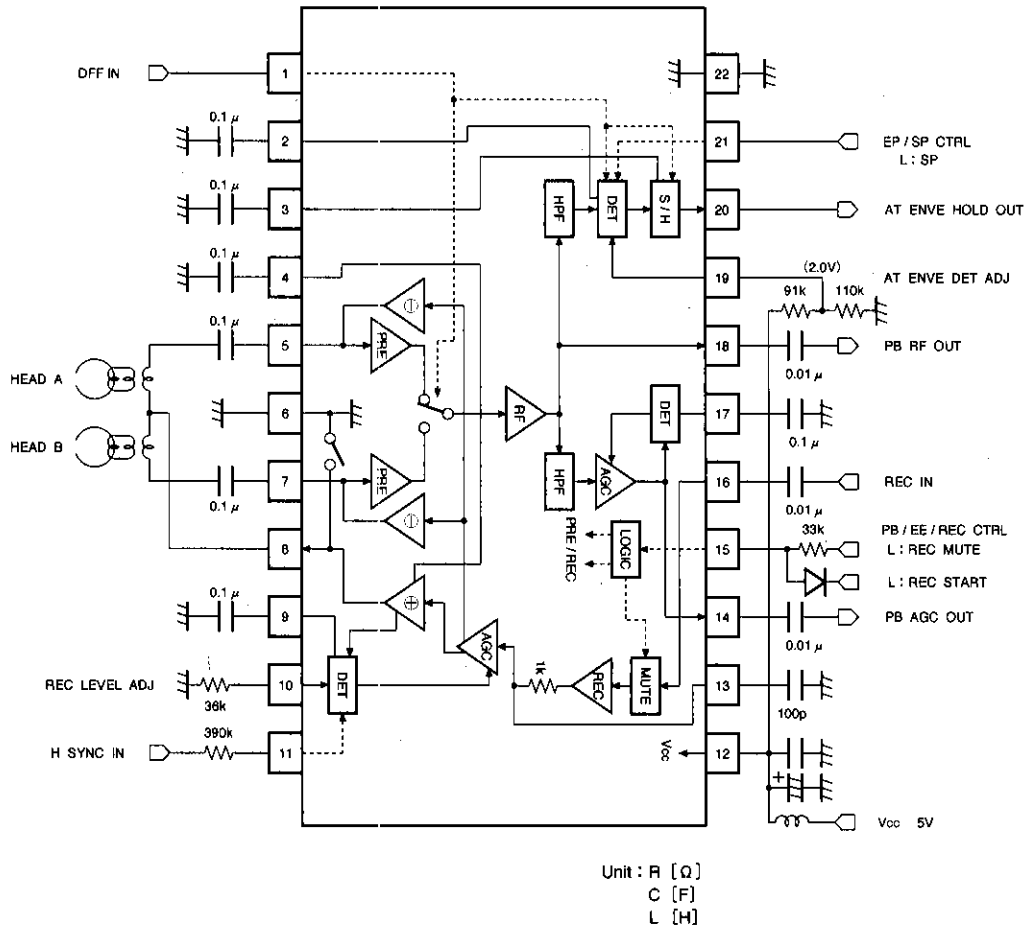
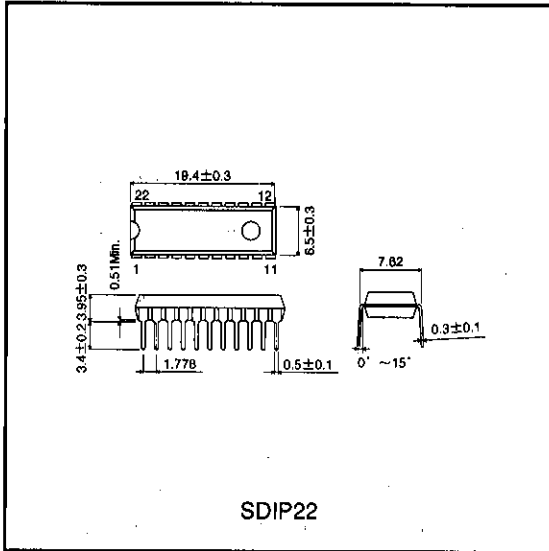

Fig.3

●External dimensions (Units: mm)



PRE/REC amplifiers

VCR components