

High-voltage audio head selection switch

BA7755A/BA7755AF

The normal audio circuits of video cassette recorders and the recording circuits of tape decks use AC bias recording to record the audio signal onto the tape. This bias voltage is some tens of volts, and a high-capacity bias-side switch is required to electronically switch the head when in playback or record mode.

The BA7755A and BA7755AF are high-voltage switching ICs designed to switch voltages as high as $\pm 65\text{Vdc}$ or $\text{AC}120\text{Vp-p}$ ($f=70\text{Hz}$).

Two control systems, one for current control, and one for voltage control are provided, so the ICs can be used in circuits that employ either method.

By combining the BA7755A or BA7755AF with the BA7751ALS recording/playback amplifier is possible to construct a compact recording/playback audio circuit. In addition, the BA7755A and BA7755AF are an excellent choice for a wide variety of other high-voltage switching applications.

●Applications

Video cassette recorders and tape decks

●Features

- 1) High withstanding voltage ($\pm 65\text{Vdc}$ (Min.), $\text{AC}120\text{Vp-p}$ (Min.), $f=70\text{Hz}$).
- 2) Circuits for either current control or voltage control are provided on the chip.
- 3) Compact SIP 5pin or SOP 8pin package.

●Block diagram

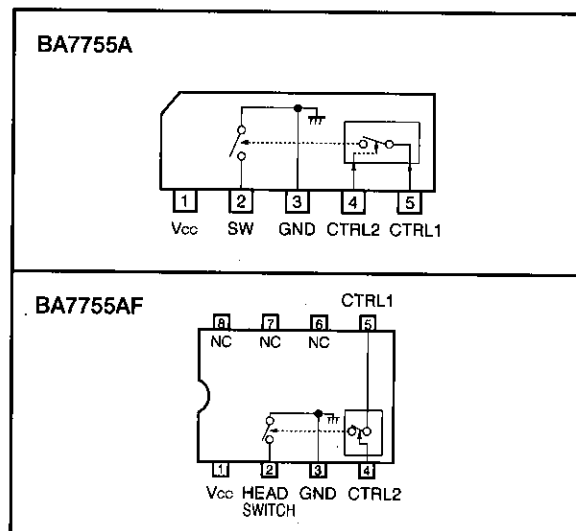

● Absolute maximum ratings (Ta=25°C)

Parameter	Symbol	Limits	Unit
Power supply voltage	V _{CC}	15	V
Power dissipation	P _d	400*1	mW
Operating temperature	T _{opr}	-10~65	°C
Storage temperature	T _{stg}	-55~125	°C
DC breakdown voltage of switch (pin 2)	BV _{CC2}	±65	V

* Reduced by 4mW for each increase in Ta of 1°C over 25°C.

● Recommended operating conditions (Ta=25°C)

Parameter	Symbol	Min.	Typ.	Max.	Unit
Operating voltage	V _{CC}	4	9	13	V

● Electrical characteristics (Unless otherwise specified Ta=25°C and V_{CC}=9V)

Parameter	Symbol	Min.	Typ.	Max.	Unit	Conditions
Circuit current	I _{CC1}	—	0	10	μA	4pin "L" or "OPEN" 5pin "OPEN"
Circuit current	I _{CC2}	2.4	3.9	5.6	mA	Pin 4 "L" or "OPEN" Pin 5 control current: 200 μA
Switch-on resistance	R _{ON}	—	8.0	15.0	Ω	Pin 4 "L" or "OPEN" Pin 5 control current: 200 μA
Switch leakage current	I _{LOFF}	—	0	10	μA	Pin 4 "H", "OPEN", or "L" Pin 5 "OPEN", pin 2 applied voltage ±65V
Switch AC breakdown voltage	BV _{AC}	120	160	—	V _{P-P}	f=70kHz
Switch offset voltage	V _{OS}	—	4.3	15.0	mV	Pin 4 "L" or "OPEN" Pin 5 control current: 200 μA
CTRL1 SW ON control current	I _{CTRL1 (ON)}	50	—	—	μA	—
CTRL1 SW OFF control current	I _{CTRL1 (OFF)}	—	—	1	μA	—
CTRL2 threshold voltage	V _{TH1}	1.70	2.15	2.60	V	—
CTRL2 input resistance	R _{CTRL2}	21.0	31.0	42.0	kΩ	—

High-voltage head selection switch

VCR components

● Switch control methods

1) Control with pins 4 and 5

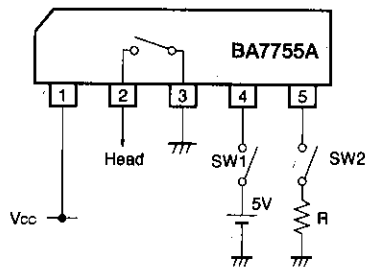

Fig.1

SW1	SW2	Between pins 2 and 3
OFF	OFF	High impedance
	ON	Low impedance
ON	OFF	High impedance
	ON	High impedance

$$R \approx \frac{V_{CC} - 1.4(V)}{200(\mu A)} \approx 10 [k\Omega]$$

When $V_{CC} = 9V$ (approx) $R \approx 28k\Omega$

2) Control with pin 4 only

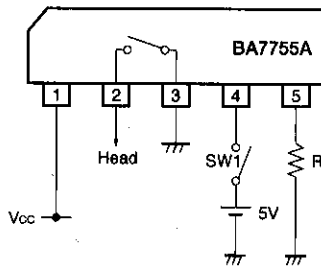

Fig.2

SW1	Between pins 2 and 3
OFF	Low impedance
ON	High impedance

3) When used with the BA7751ALS

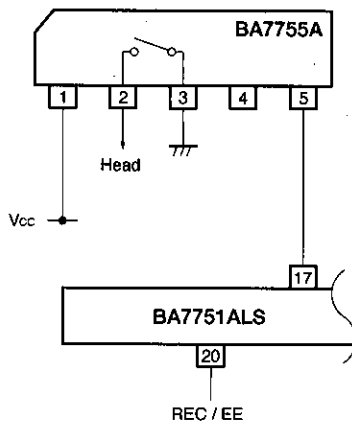
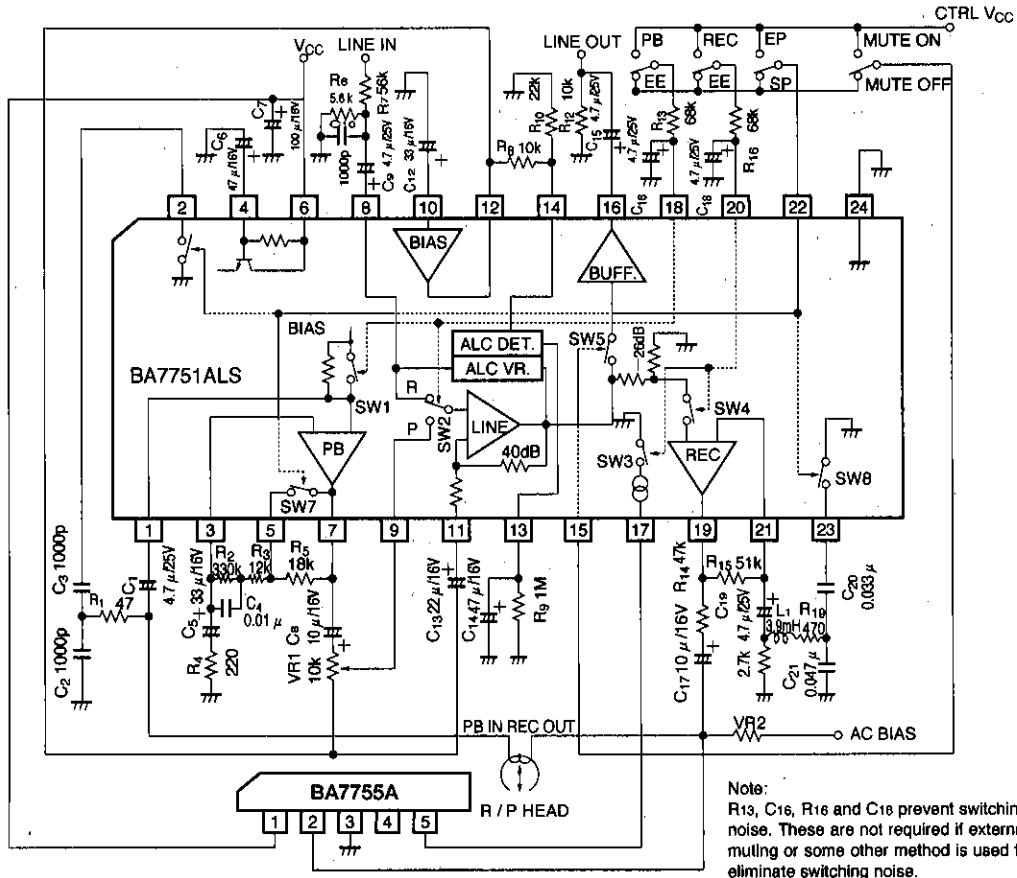

Fig.3

REC / EEE	Between pins 2 and 3
EE (L)	Low impedance
REC (H)	High impedance

●Application example



High-voltage head selection switch

VCR components

●External dimensions (Units: mm)

