



CD4018BM/CD4018BC Presettable Divide-by-N Counter

General Description

The CD4018B consists of 5 Johnson counter stages. A buffered \bar{Q} output from each stage, "CLOCK", "RESET", "DATA", "PRESET ENABLE", and 5 individual "JAM" inputs are provided. The counter is advanced one count at the positive clock signal transition. A high "RESET" signal clears the counters to an "ALL ZERO" condition. A high "PRESET ENABLE" signal allows information on the "JAM" inputs to preset the counter. Anti-lock gating is provided to assure the proper counting sequence.

Features

- Wide supply voltage range 3.0V to 15V
- High noise immunity 0.45V_{DD} (typ.)
- Low power TTL compatibility fan out of 2 driving 74L or 1 driving 74LS
- Fully static operation

Applications

- Fixed and programmable divide-by-10, 9, 8, 7, 6, 5, 4, 3, 2 counter
- Fixed and programmable counters greater than 10
- Programmable decade counters
- Divide by "N" counters/frequency synthesizers

Logic Diagram

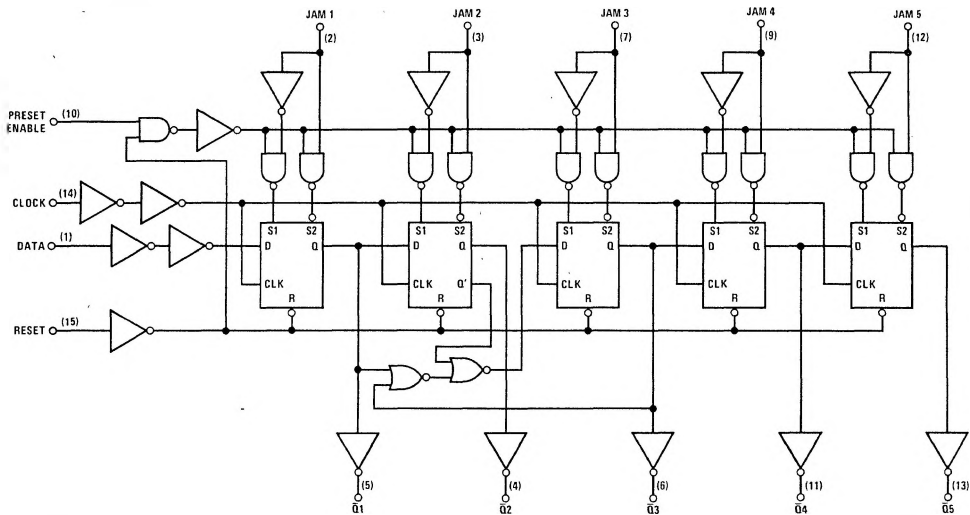

Connection Diagram

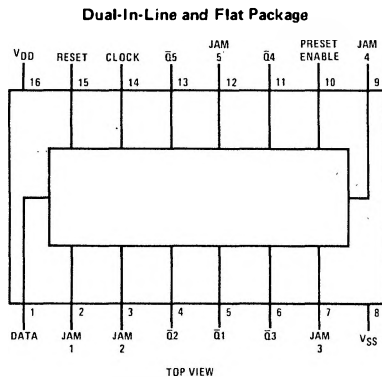

Absolute Maximum Ratings (Note 1)

(Notes 1 and 2)

V _{DD} dc Supply Voltage	-0.5 to +18 V _{DC}
V _{IN} Input Voltage	-0.5 to V _{DD} + 0.5 V _{DC}
T _S Storage Temperature Range	-65°C to +150°C
P _D Package Dissipation	500 mW
T _L Lead Temperature (Soldering, 10 seconds)	300°C

Recommended Operating Conditions

(Note 2)

V _{DD} dc Supply Voltage	3 to 15 V _{DC}
V _{IN} Input Voltage	0 to V _{DD} V _{DC}
T _A Operating Temperature Range	-55°C to +125°C
CD4018BM	-40°C to +85°C
CD4018BC	

DC Electrical Characteristics CD4018BM (Note 2)

PARAMETER	CONDITIONS	-55°C		25°C			125°C		UNITS
		MIN	MAX	MIN	TYP	MAX	MIN	MAX	
I _{DD} Quiescent Device Current	V _{DD} = 5V		5		0.3	5		150	μA
	V _{DD} = 10V		10		0.5	10		300	μA
	V _{DD} = 15V		20		1.0	20		600	μA
V _{OL} Low Level Output Voltage	I _{IO} < 1 μA								
	V _{DD} = 5V		0.05		0	0.05		0.05	V
	V _{DD} = 10V		0.05		0	0.05		0.05	V
V _{OH} High Level Output Voltage	I _{IO} < 1 μA								
	V _{DD} = 5V	4.95		4.95	5		4.95		V
	V _{DD} = 10V	9.95		9.95	10		9.95		V
V _{IL} Low Level Input Voltage	V _{DD} = 5V, V _O = 0.5V or 4.5V		1.5		2.25	1.5		1.5	V
	V _{DD} = 10V, V _O = 1V or 9V		3.0		4.5	3.0		3.0	V
	V _{DD} = 15V, V _O = 1.5V or 13.5V		4.0		6.75	4.0		4.0	V
V _{IH} High Level Input Voltage	V _{DD} = 5V, V _O = 0.5V or 4.5V	3.5		3.5	2.75		3.5		V
	V _{DD} = 10V, V _O = 1V or 9V	7.0		7.0	5.5		7.0		V
	V _{DD} = 15V, V _O = 1.5V or 13.5V	11.0		11.0	8.25		11.0		V
I _{OL} Low Level Output Current	V _{DD} = 5V, V _O = 0.4V	0.64		0.51	0.88		0.36		mA
	V _{DD} = 10V, V _O = 0.5V	1.6		1.3	2.25		0.9		mA
	V _{DD} = 15V, V _O = 1.5V	4.2		3.4	8.8		2.4		mA
I _{OH} High Level Output Current	V _{DD} = 5V, V _O = 4.6V	-0.64		-0.51	-0.88		-0.36		mA
	V _{DD} = 10V, V _O = 9.5V	-1.6		-1.3	-2.25		-0.9		mA
	V _{DD} = 15V, V _O = 13.5V	-4.2		-3.4	-8.8		-2.4		mA
I _{IN} Input Current	V _{DD} = 15V, V _{IN} = 0V		-0.1		-10 ⁻⁵	-0.1		-1.0	μA
	V _{DD} = 15V, V _{IN} = 15V		0.1		10 ⁻⁵	0.1		1.0	μA

DC Electrical Characteristics CD4018BC (Note 2)

PARAMETER	CONDITIONS	-40°C		25°C			85°C		UNITS
		MIN	MAX	MIN	TYP	MAX	MIN	MAX	
I _{DD} Quiescent Device Current	V _{DD} = 5V		20		0.5	20		150	μA
	V _{DD} = 10V		40		1.0	40		300	μA
	V _{DD} = 15V		80		5.0	80		600	μA
V _{OL} Low Level Output Voltage	I _{IO} < 1 μA								
	V _{DD} = 5V		0.05		0	0.05		0.05	V
	V _{DD} = 10V		0.05		0	0.05		0.05	V
V _{OH} High Level Output Voltage	I _{IO} < 1 μA								
	V _{DD} = 5V	4.95		4.95	5		4.95		V
	V _{DD} = 10V	9.95		9.95	10		9.95		V
V _{IL} Low Level Input Voltage	V _{DD} = 5V, V _O = 0.5V or 4.5V		1.5		2.25	1.5		1.5	V
	V _{DD} = 10V, V _O = 1V or 9V		3.0		4.5	3.0		3.0	V
	V _{DD} = 15V, V _O = 1.5V or 13.5V		4.0		6.75	4.0		4.0	V
V _{IH} High Level Input Voltage	V _{DD} = 5V, V _O = 0.5V or 4.5V	3.5		3.5	2.75		3.5		V
	V _{DD} = 10V, V _O = 1V or 9V	7.0		7.0	5.5		7.0		V
	V _{DD} = 15V, V _O = 1.5V or 13.5V	11.0		11.0	8.25		11.0		V

CD4018BM/CD4018BC

DC Electrical Characteristics (Continued) CD4018BC

PARAMETER	CONDITIONS	-40°C		25°C			85°C		UNITS
		MIN	MAX	MIN	TYP	MAX	MIN	MAX	
I _{OL} Low Level Output Current	V _{DD} = 5V, V _O = 0.4V	0.52		0.44	0.88		0.36		mA
	V _{DD} = 10V, V _O = 0.5V	1.3		1.1	2.25		0.9		mA
	V _{DD} = 15V, V _O = 1.5V	3.6		3.0	8.8		2.4		mA
I _{OH} High Level Output Current	V _{DD} = 5V, V _O = 4.6V	-0.52		-0.44	-0.88		-0.36		mA
	V _{DD} = 10V, V _O = 9.5V	-1.3		-1.1	-2.25		-0.9		mA
	V _{DD} = 15V, V _O = 13.5V	-3.6		-3.0	-8.8		-2.4		mA
I _{IN} Input Current	V _{DD} = 15V, V _{IN} = 0V		-0.30		-10 ⁻⁵	-0.3		-1.0	μA
	V _{DD} = 15V, V _{IN} = 15V		0.30		10 ⁻⁵	0.3		1.0	μA

AC Electrical Characteristics

T_A = 25°C, C_L = 50 pF, R_L = 200k, Input t_r = t_f = 20 ns, unless otherwise specified

PARAMETER	CONDITIONS	MIN	TYP	MAX	UNITS
CLOCK OPERATION					
t _{PHL} , t _{PLH} Propagation Delay Time to \bar{Q}	V _{DD} = 5V		235	700	ns
	V _{DD} = 10V		95	250	ns
	V _{DD} = 15V		70	200	ns
t _{THL} , t _{TLH} Transition Time \bar{Q} Outputs	V _{DD} = 5V		125	250	ns
	V _{DD} = 10V		65	130	ns
	V _{DD} = 15V		50	100	ns
t _{WL} , t _{WH} Minimum Clock Pulse Width	V _{DD} = 5V		125	500	ns
	V _{DD} = 10V		50	200	ns
	V _{DD} = 15V		40	160	ns
t _{RCL} , t _{FCL} Clock Rise and Fall Time	V _{DD} = 5V			15	μs
	V _{DD} = 10V			15	μs
	V _{DD} = 15V			15	μs
t _{SU} Minimum Data Input Set-Up Time	V _{DD} = 5V		40	200	ns
	V _{DD} = 10V		20	100	ns
	V _{DD} = 15V		16	80	ns
f _{CL} Maximum Clock Frequency	V _{DD} = 5V	1	4		MHz
	V _{DD} = 10V	3	9		MHz
	V _{DD} = 15V	5	14		MHz
PRESET OR RESET OPERATION					
t _{PLH(R)} Propagation Delay Time to \bar{Q}	V _{DD} = 5V		235	750	ns
t _{PHL(PR)}	V _{DD} = 10V		95	250	ns
t _{PLH(PR)}	V _{DD} = 15V		70	200	ns
t _{WH(R)} Minimum Preset or Reset Pulse Width	V _{DD} = 5V		100	400	ns
	V _{DD} = 10V		40	160	ns
	V _{DD} = 15V		30	120	ns
t _{REM} Minimum Preset or Reset Removal Time	V _{DD} = 5V		100	400	ns
	V _{DD} = 10V		40	160	ns
	V _{DD} = 15V		30	120	ns
C _{IN} Average Input Capacitance	Any Input		5	7.5	pF
C _{PD} Power Dissipation Capacitance	(Note 3)		63		pF

Note 1: "Absolute Maximum Ratings" are those values beyond which the safety of the device cannot be guaranteed; they are not meant to imply that the devices should be operated at these limits. The table of "Recommended Operating Conditions" and "Electrical Characteristics" provides conditions for actual device operation.

Note 2: V_{SS} = 0V unless otherwise specified.

Note 3: C_{PD} determines the no load ac power consumption of any CMOS device. For complete explanation, see 54C/74C family characteristics application note AN-90.

Typical Performance Characteristics

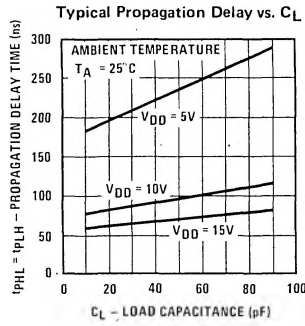
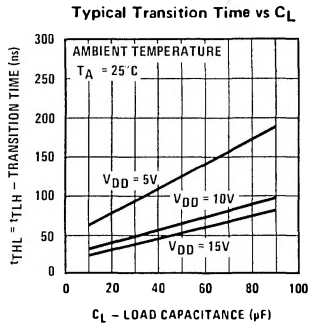

External Connections

External Connections for Divide by 10, 9, 8, 7, 6, 5, 4, 3, 2, Operation

Divide By 10 $\bar{Q}5$
 Divide By 8 $Q4$
 Divide By 6 $Q3$
 Divide By 4 $Q2$
 Divide By 2 $Q1$

Connected Back To "DATA" Input

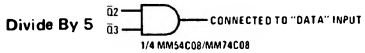
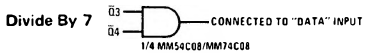

Timing Diagram

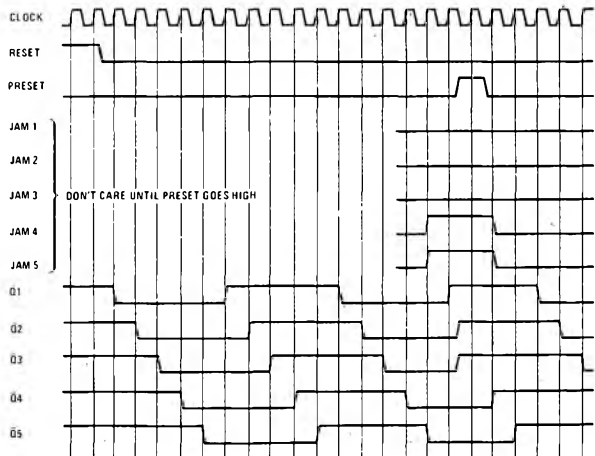

Note. "Data" input tied to $\bar{Q}5$ for decade counter configuration.