



CD4047BM/CD4047BC Low Power Monostable/Astable Multivibrator

General Description

CD4047B is capable of operating in either the monostable or astable mode. It requires an external capacitor (between pins 1 and 3) and an external resistor (between pins 2 and 3) to determine the output pulse width in the monostable mode, and the output frequency in the astable mode.

Astable operation is enabled by a high level on the astable input or low level on the astable input. The output frequency (at 50% duty cycle) at Q and \bar{Q} outputs is determined by the timing components. A frequency twice that of Q is available at the Oscillator Output; a 50% duty cycle is not guaranteed.

Monostable operation is obtained when the device is triggered by low-to-high transition at + trigger input or high-to-low transition at - trigger input. The device can be retrigged by applying a simultaneous low-to-high transition to both the + trigger and retrigger inputs.

A high level on Reset input resets the outputs Q to low, \bar{Q} to high.

Features

- Wide supply voltage range 3.0V to 15V
- High noise immunity 0.45 V_{DD} (typ.)
- Low power TTL compatibility fan out of 2 driving 74L or 1 driving 74LS

SPECIAL FEATURES

- Low power consumption: special CMOS oscillator configuration
- Monostable (one-shot) or astable (free-running) operation
- True and complemented buffered outputs
- Only one external R and C required

MONOSTABLE MULTIVIBRATOR FEATURES

- Positive- or negative-edge trigger
- Output pulse width independent of trigger pulse duration
- Retriggerable option for pulse width expansion
- Long pulse widths possible using small RC components by means of external counter provision
- Fast recovery time essentially independent of pulse width
- Pulse-width accuracy maintained at duty cycles approaching 100%

ASTABLE MULTIVIBRATOR FEATURES

- Free-running or gatable operating modes
- 50% duty cycle
- Oscillator output available
- Good astable frequency stability
 - typical $= \pm 2\% + 0.03\%/^{\circ}\text{C}$ @ 100kHz
 - frequency deviation $= \pm 0.5\% + 0.015\%/^{\circ}\text{C}$ @ 10kHz
 - (circuits trimmed to frequency V_{DD} = 10V ± 10%)

Applications

- Frequency discriminators
- Timing circuits
- Time-delay applications
- Envelope detection
- Frequency multiplication
- Frequency division

Block and Connection Diagrams

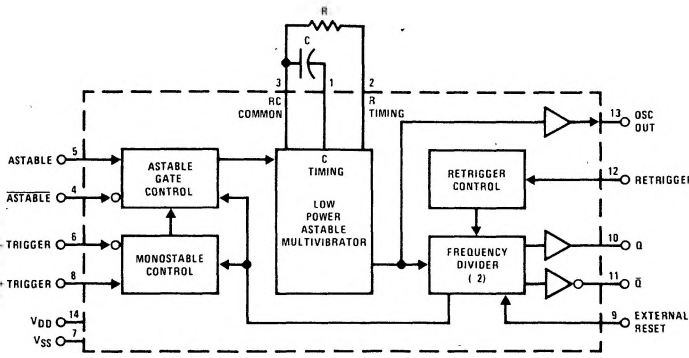

Dual-In-Line and Flat Package

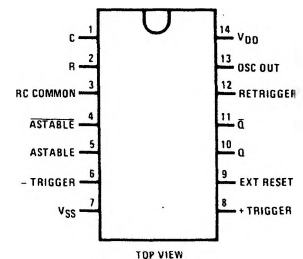

Absolute Maximum Ratings

(Notes 1 and 2)

V _{DD} dc Supply Voltage	-0.5 to +18V _{DC}
V _{IN} Input Voltage	-0.5 to V _{DD} + 0.5V _{DC}
T _S Storage Temperature Range	-65°C to +150°C
P _D Package Dissipation	500 mW
T _L Lead Temperature (Soldering, 10 seconds)	300°C

Recommended Operating Conditions

(Note 2)

V _{DD} dc Supply Voltage	3 to 15V _{DC}
V _{IN} Input Voltage	0 to V _{DD} V _{DC}
T _A Operating Temperature Range	-55°C to +125°C
CD4047BM	-40°C to +85°C
CD4047BC	

DC Electrical Characteristics CD4047BM (Note 2)

PARAMETER	CONDITIONS	-55°C		25°C			125°C		UNITS
		MIN	MAX	MIN	TYP	MAX	MIN	MAX	
I _{DD} Quiescent Device Current	V _{DD} = 5V		5			5		150	μA
	V _{DD} = 10V		10			10		300	μA
	V _{DD} = 15V		20			20		600	μA
V _{OL} Low Level Output Voltage	I _O < 1 μA								
	V _{DD} = 5V		0.05		0	0.05		0.05	V
	V _{DD} = 10V		0.05		0	0.05		0.05	V
V _{OH} High Level Output Voltage	I _O < 1 μA								
	V _{DD} = 5V	4.95		4.95	5		4.95		V
	V _{DD} = 10V	9.95		9.95	10		9.95		V
V _{IL} Low Level Input Voltage	V _{DD} = 5V, V _O = 0.5V or 4.5V		1.5		2.25	1.5		1.5	V
	V _{DD} = 10V, V _O = 1V or 9V		3.0		4.5	3.0		3.0	V
	V _{DD} = 15V, V _O = 1.5V or 13.5V		4.0		6.75	4.0		4.0	V
V _{IH} High Level Input Voltage	V _{DD} = 5V, V _O = 0.5V or 4.5V	3.5		3.5	2.75		3.5		V
	V _{DD} = 10V, V _O = 1V or 9V	7.0		7.0	5.5		7.0		V
	V _{DD} = 15V, V _O = 1.5V or 13.5V	11.0		11.0	8.25		11.0		V
I _{OL} Low Level Output Current	V _{DD} = 5V, V _O = 0.4V	0.64		0.51	0.88		0.36		mA
	V _{DD} = 10V, V _O = 0.5V	1.6		1.3	2.25		0.9		mA
	V _{DD} = 15V, V _O = 1.5V	4.2		3.4	8.8		2.4		mA
I _{OH} High Level Output Current	V _{DD} = 5V, V _O = 4.6V	-0.64		-0.51	-0.88		-0.36		mA
	V _{DD} = 10V, V _O = 9.5V	-1.6		-1.3	-2.25		-0.9		mA
	V _{DD} = 15V, V _O = 13.5V	-4.2		-3.4	-8.8		-2.4		mA
I _{IN} Input Current	V _{DD} = 15V, V _{IN} = 0V		-0.1		-10 ⁻⁵	-0.1		-1.0	μA
	V _{DD} = 15V, V _{IN} = 15V		0.1		10 ⁻⁵	0.1		1.0	μA

DC Electrical Characteristics CD4047BC (Note 2)

PARAMETER	CONDITIONS	-40°C		25°C			85°C		UNITS
		MIN	MAX	MIN	TYP	MAX	MIN	MAX	
I _{DD} Quiescent Device Current	V _{DD} = 5V		20			20		150	μA
	V _{DD} = 10V		40			40		300	μA
	V _{DD} = 15V		80			80		600	μA
V _{OL} Low Level Output Voltage	I _O < 1 μA								
	V _{DD} = 5V		0.05		0	0.05		0.05	V
	V _{DD} = 10V		0.05		0	0.05		0.05	V
	V _{DD} = 15V		0.05		0	0.05		0.05	V

DC Electrical Characteristics (Cont'd.) CD4047BC (Note 2)

PARAMETER	CONDITIONS	-40°C		25°C			85°C		UNITS
		MIN	MAX	MIN	TYP	MAX	MIN	MAX	
V _{OH} High Level Output Voltage	I _O < 1 μA								
	V _{DD} = 5V	4.95		4.95	5		4.95		V
	V _{DD} = 10V	9.95		9.95	10		9.95		V
	V _{DD} = 15V	14.95		14.95	15		14.95		V
V _{IL} Low Level Input Voltage	V _{DD} = 5V, V _O = 0.5V or 4.5V		1.5		2.25	1.5		1.5	V
	V _{DD} = 10V, V _O = 1V or 9V		3.0		4.5	3.0		3.0	V
	V _{DD} = 15V, V _O = 1.5V or 13.5V		4.0		6.75	4.0		4.0	V
V _{IH} High Level Input Voltage	V _{DD} = 5V, V _O = 0.5V or 4.5V	3.5		3.5	2.75		3.5		V
	V _{DD} = 10V, V _O = 1V or 9V	7.0		7.0	5.5		7.0		V
	V _{DD} = 15V, V _O = 1.5V or 13.5V	11.0		11.0	8.25		11.0		V
I _{OL} Low Level Output Current	V _{DD} = 5V, V _O = 0.4V	0.52		0.44	0.88		0.36		mA
	V _{DD} = 10V, V _O = 0.5V	1.3		1.1	2.25		0.9		mA
	V _{DD} = 15V, V _O = 1.5V	3.6		3.0	8.8		2.4		mA
I _{OH} High Level Output Current	V _{DD} = 5V, V _O = 4.6V	-0.52		-0.44	-0.88		-0.36		mA
	V _{DD} = 10V, V _O = 9.5V	-1.3		-1.1	-2.25		-0.9		mA
	V _{DD} = 15V, V _O = 13.5V	-3.6		-3.0	-8.8		-2.4		mA
I _{IN} Input Current	V _{DD} = 15V, V _{IN} = 0V		-0.3		-10 ⁻⁵	-0.3		-1.0	μA
	V _{DD} = 15V, V _{IN} = 15V		0.3		10 ⁻⁵	0.3		1.0	μA

Note 1: "Absolute Maximum Ratings" are those values beyond which the safety of the device cannot be guaranteed, they are not meant to imply that the devices should be operated at these limits. The table of "Recommended Operating Conditions" and "Electrical Characteristics" provides conditions for actual device operation.

Note 2: V_{SS} = 0V unless otherwise specified.

AC Electrical Characteristics CD4047B

T_A = 25°C, C_L = 50 pF, R_L = 200k, Input t_r = t_f = 20 ns, unless otherwise specified.

PARAMETER	CONDITIONS	MIN	TYP	MAX	UNITS
t _{PHL} , t _{PLH} Propagation Delay Time Astable, Astable to Osc Out	V _{DD} = 5V		200	400	ns
	V _{DD} = 10V		100	200	ns
	V _{DD} = 15V		80	160	ns
t _{PHL} , t _{PLH} Astable, Astable to Q, \bar{Q}	V _{DD} = 5V		550	900	ns
	V _{DD} = 10V		250	500	ns
	V _{DD} = 15V		200	400	ns
t _{PHL} , t _{PLH} + Trigger, - Trigger to Q, \bar{Q}	V _{DD} = 5V		700	1200	ns
	V _{DD} = 10V		300	600	ns
	V _{DD} = 15V		240	480	ns
t _{PHL} , t _{PLH} + Trigger, Retrigger to Q, \bar{Q}	V _{DD} = 5V		300	600	ns
	V _{DD} = 10V		175	300	ns
	V _{DD} = 15V		150	250	ns
t _{PHL} , t _{PLH} Reset to Q, \bar{Q}	V _{DD} = 5V		300	600	ns
	V _{DD} = 10V		125	250	ns
	V _{DD} = 15V		100	200	ns
t _{THL} , t _{TLH} Transition Time Q, \bar{Q} , Osc Out	V _{DD} = 5V		100	200	ns
	V _{DD} = 10V		50	100	ns
	V _{DD} = 15V		40	80	ns
t _{WL} , t _{WH} Minimum Input Pulse Duration	Any Input				
	V _{DD} = 5V		500	1000	ns
	V _{DD} = 10V		200	400	ns
	V _{DD} = 15V		160	320	ns
t _{RCL} , t _{FCL} + Trigger, Retrigger, Rise and Fall Time	V _{DD} = 5V			15	μs
	V _{DD} = 10V			5	μs
	V _{DD} = 15V			5	μs
C _{IN} Average Input Capacitance	Any Input		5	7.5	pF

Logic Diagram

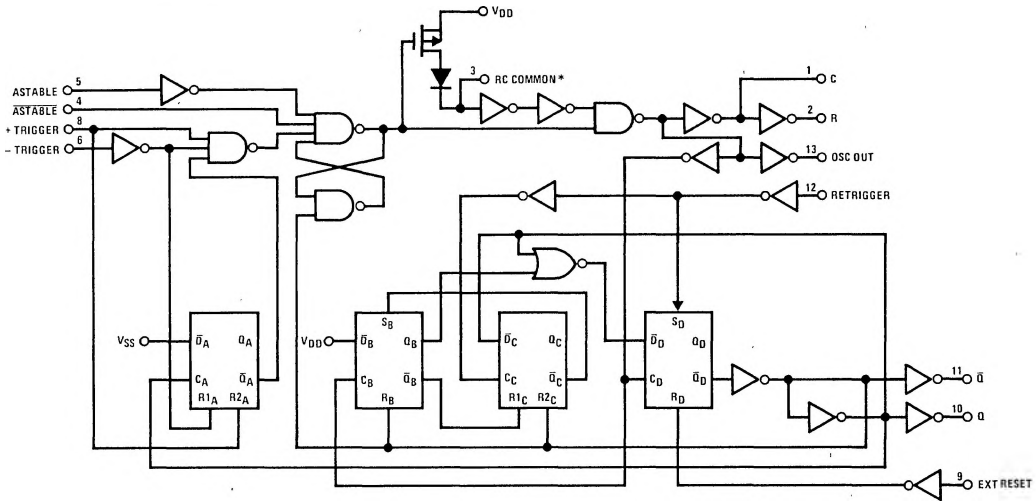

*Special input protection circuit to permit larger input-voltage swings

Truth Table

FUNCTION	TERMINAL CONNECTIONS			OUTPUT PULSE FROM	TYPICAL OUTPUT PERIOD OR PULSE WIDTH
	TO V _{DD}	TO V _{SS}	INPUT PULSE TO		
Astable Multivibrator	4, 5, 6, 14	7, 8, 9, 12		10, 11, 13	$t_A(10, 11) = 4.40 RC$ $t_A(13) = 2.20 RC$
	4, 6, 14	7, 8, 9, 12	5	10, 11, 13	
	6, 14	5, 7, 8, 9, 12	4	10, 11, 13	
Monostable Multivibrator	4, 14	5, 6, 7, 9, 12	8	10, 11	$t_M(10, 11) = 2.48 RC$
	4, 8, 14	5, 7, 9, 12	6	10, 11	
	4, 14	5, 6, 7, 9	8, 12	10, 11	
	14	5, 6, 7, 8, 9, 12	(See Figure)	(See Figure)	

Note: External resistor between terminals 2 and 3. External capacitor between terminals 1 and 3.

* Typical Implementation of External Countdown Option

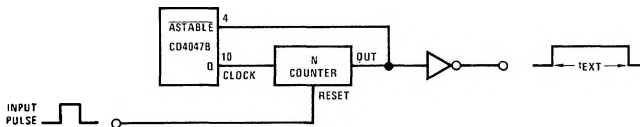

$$t_{EXT} = (N - 1) t_A + (t_M + t_A/2)$$

Typical Performance Characteristics

Typical Q, \bar{Q} , Osc Out Period Accuracy vs Supply Voltage (Astable Mode Operation)

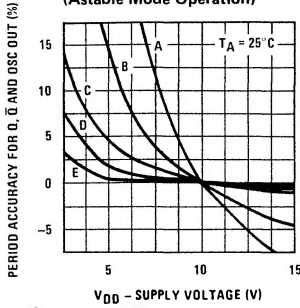

$f_{Q, \bar{Q}}$	R	C
A 1000 kHz	22k	10 pF
B 100 kHz	22k	100 pF
C 10 kHz	220k	100 pF
D 1 kHz	220k	1000 pF
E 100 Hz	2.2M	1000 pF

Typical Q, \bar{Q} , Pulse Width Accuracy vs Supply Voltage Monostable Mode Operation

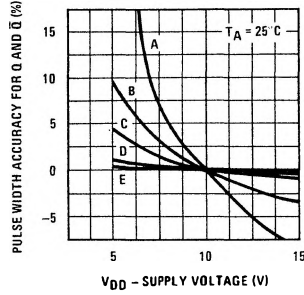

t_M	R	C
A 2 μ s	22k	10 pF
B 7 μ s	22k	100 pF
C 60 μ s	220k	100 pF
D 550 μ s	220k	1000 pF
E 5.5 ms	2.2M	1000 pF

Typical Q, \bar{Q} and Osc Out Period Accuracy vs Temperature Astable Mode Operation

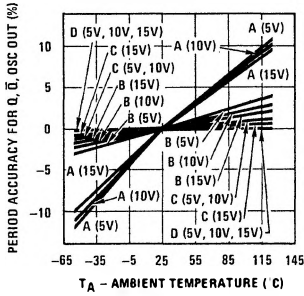

$f_{Q, \bar{Q}}$	R	C
A 1000 kHz	22k	10 pF
B 100 kHz	22k	100 pF
C 10 kHz	220k	100 pF
D 1 kHz	220k	1000 pF

Typical Q and \bar{Q} Pulse Width Accuracy vs Temperature Monostable Mode Operation

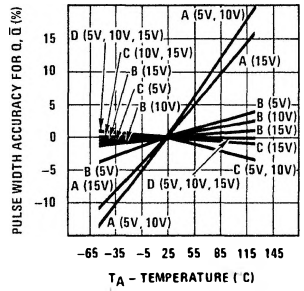

t_M	R	C
A 2 μ s	22k	10 pF
B 7 μ s	22k	100 pF
C 60 μ s	220k	100 pF
D 550 μ s	220k	1000 pF

Timing Diagram

