



CD4066BM/CD4066BC Quad Bilateral Switch

General Description

The CD4066BM/CD4066BC is a quad bilateral switch intended for the transmission or multiplexing of analog or digital signals. It is pin-for-pin compatible with CD4016BM/CD4016BC, but has a much lower "ON" resistance, and "ON" resistance is relatively constant over the input-signal range.

Features

- Wide supply voltage range 3V to 15V
- High noise immunity 0.45 V_{DD} (typ.)
- Wide range of digital and analog switching ±7.5 V_{PEAK}
- "ON" resistance for 15 V operation 80 Ω
- Matched "ON" resistance over 15 V signal input ΔR_{ON} = 5 Ω (typ.)
- "ON" resistance flat over peak-to-peak signal range
- High "ON"/"OFF" output voltage ratio @ f_{is} = 10 kHz, R_L = 10 kΩ 65 dB (typ.)
- High degree linearity @ f_{is} = 1 kHz, V_{is} = 5 V_{p-p}, V_{DD} - V_{SS} = 10 V, R_L = 10 kΩ 0.1% distortion (typ.)

- Extremely low "OFF" switch leakage 0.1 nA (typ.) @ V_{DD} - V_{SS} = 10 V, T_A = 25°C
- Extremely high control input impedance 10¹² Ω (typ.)
- Low crosstalk between switches -50 dB (typ.) @ f_{is} = 0.9 MHz, R_L = 1 kΩ
- Frequency response, switch "ON" 40 MHz (typ.)

Applications

- Analog signal switching/multiplexing
 - Signal gating
 - Squelch control
 - Chopper
 - Modulator/Demodulator
 - Commutating switch
- Digital signal switching/multiplexing
- CMOS logic implementation
- Analog-to-digital/digital-to-analog conversion
- Digital control of frequency, impedance, phase, and analog-signal-gain

Schematic and Connection Diagrams

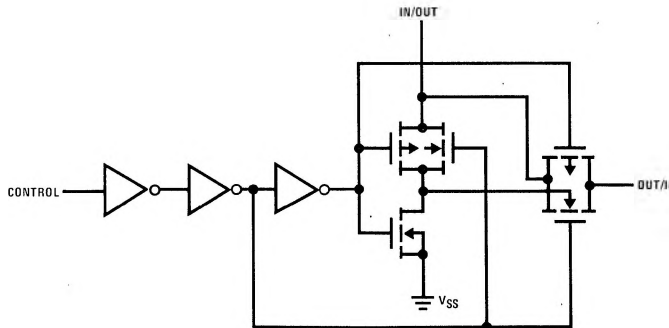

Dual-In-Line Package

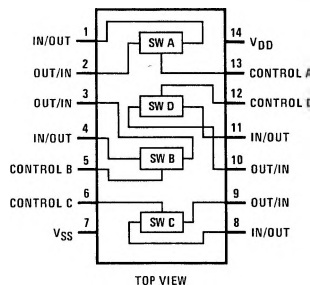

TOP VIEW

Absolute Maximum Ratings

(Notes 1 and 2)

V _{DD} Supply Voltage	-0.5V to +18V
V _{IN} Input Voltage	-0.5V to V _{DD} + 0.5V
T _S Storage Temperature Range	-65°C to +150°C
P _D Package Dissipation	500 mW
T _L Lead Temperature (Soldering, 10 seconds)	300°C

Recommended Operating Conditions

(Note 2)

V _{DD} Supply Voltage	3V to 15V
V _{IN} Input Voltage	0V to V _{DD}
T _A Operating Temperature Range	-55°C to +125°C
CD4066BM	-40°C to +85°C
CD4066BC	

DC Electrical Characteristics CD4066BM (Note 2)

Parameter	Conditions	-55°C		25°C			125°C		Units
		Min	Max	Min	Typ	Max	Min	Max	
I _{DD} Quiescent Device Current	V _{DD} = 5V		0.25		0.01	0.25		7.5	μA
	V _{DD} = 10V		0.5		0.01	0.5		15	μA
	V _{DD} = 15V		1.0		0.01	1.0		30	μA
Signal Inputs and Outputs									
R _{ON} "ON" Resistance	R _L = 10 kΩ to $\frac{V_{DD}-V_{SS}}{2}$ V _C = V _{DD} , V _{IS} = V _{SS} to V _{DD} V _{DD} = 5V V _{DD} = 10V V _{DD} = 15V		2000 400 220		270 120 80	2500 500 280		3500 550 320	Ω
ΔR _{ON} Δ "ON" Resistance Between any 2 of 4 Switches	R _L = 10 kΩ to $\frac{V_{DD}-V_{SS}}{2}$ V _C = V _{DD} , V _{IS} = V _{SS} to V _{DD} V _{DD} = 10V V _{DD} = 15V				10 5				Ω
I _{IS} Input or Output Leakage Switch "OFF"	V _C = 0 V _{IS} = 15V and 0V, V _{OS} = 0V and 15V		±50		±0.1	±50		±500	nA
Control Inputs									
V _{ILC} Low Level Input Voltage	V _{IS} = V _{SS} and V _{DD} V _{OS} = V _{DD} and V _{SS} I _{IS} = ±10 μA V _{DD} = 5V V _{DD} = 10V V _{DD} = 15V		1.5 3.0 4.0		2.25 4.5 6.75	1.5 3.0 4.0		1.5 3.0 4.0	V
	V _{IHC} High Level Input Voltage	V _{DD} = 5V	3.5		3.5	2.75		3.5	V
		V _{DD} = 10V (see note 6) V _{DD} = 15V	7.0 11.0		7.0 11.0	5.5 8.25		7.0 11.0	V
I _{IN} Input Current	V _{DD} - V _{SS} = 15V V _{DD} ≥ V _{IS} ≥ V _{SS} V _{DD} ≥ V _C ≥ V _{SS}		±0.1		±10 ⁻⁵	±0.1		±1.0	μA

DC Electrical Characteristics CD4066BC (Note 2)

Parameter	Conditions	-40°C		25°C			85°C		Units
		Min	Max	Min	Typ	Max	Min	Max	
I _{DD} Quiescent Device Current	V _{DD} = 5V		1.0		0.01	1.0		7.5	μA
	V _{DD} = 10V		2.0		0.01	2.0		15	μA
	V _{DD} = 15V		4.0		0.01	4.0		30	μA

DC Electrical Characteristics (Cont'd.) CD4066BC (Note 2)

Parameter	Conditions	-40°C		25°C			85°C		Units	
		Min	Max	Min	Typ	Max	Min	Max		
Signal Inputs and Outputs										
R _{ON}	"ON" Resistance	$R_L = 10\text{ k}\Omega$ to $\frac{V_{DD} - V_{SS}}{2}$								
	$V_C = V_{DD}$, V_{SS} to V_{DD}									
	$V_{DD} = 5\text{ V}$	2000		270 2500			3200		Ω	
	$V_{DD} = 10\text{ V}$	450		120 500			520		Ω	
	$V_{DD} = 15\text{ V}$	250		80 280			300		Ω	
ΔR_{ON}	Δ "ON" Resistance Between Any 2 of 4 Switches	$R_L = 10\text{ k}\Omega$ to $\frac{V_{DD} - V_{SS}}{2}$								
	$V_{CC} = V_{DD}$, $V_{IS} = V_{SS}$ to V_{DD}									
	$V_{DD} = 10\text{ V}$			10					Ω	
	$V_{DD} = 15\text{ V}$			5					Ω	
I _{IS}	Input or Output Leakage Switch "OFF"	$V_C = 0$		± 50			$\pm 0.1 \pm 50$		nA	
Control Inputs										
V _{ILC}	Low Level Input Voltage	$V_{IS} = V_{SS}$ and V_{DD} $V_{OS} = V_{DD}$ and V_{SS} $I_{IS} = \pm 10\mu\text{A}$								
	$V_{DD} = 5\text{ V}$	1.5		2.25 1.5			1.5		V	
	$V_{DD} = 10\text{ V}$	3.0		4.5 3.0			3.0		V	
	$V_{DD} = 15\text{ V}$	4.0		6.75 4.0			4.0		V	
V _{IHC}	High Level Input Voltage	$V_{DD} = 5\text{ V}$		3.5			3.5		V	
	$V_{DD} = 10\text{ V}$ (See note 6)	7.0		7.0			7.0		V	
	$V_{DD} = 15\text{ V}$	11.0		11.0			11.0		V	
I _{IN}	Input Current	$V_{DD} - V_{SS} = 15\text{ V}$ $V_{DD} \geq V_{IS} \geq V_{SS}$ $V_{DD} \geq V_C \geq V_{SS}$		± 0.3			$\pm 10^{-5} \pm 0.3$			μA

AC Electrical Characteristics $T_A = 25^\circ\text{C}$, $t_r = t_f = 20\text{ ns}$ and $V_{SS} = 0\text{ V}$ unless otherwise specified

Parameter	Conditions	Min	Typ	Max	Units
t _{PHL} , t _{PLH}	Propagation Delay Time Signal Input to Signal Output $V_C = V_{DD}$, $C_L = 50\text{ pF}$, (Figure 1) $R_L = 200\text{ k}$ $V_{DD} = 5\text{ V}$ $V_{DD} = 10\text{ V}$ $V_{DD} = 15\text{ V}$		25 15 10	55 35 25	ns ns ns
t _{PZH} , t _{PZL}	Propagation Delay Time Control Input to Signal Output High Impedance to Logical Level $R_L = 1.0\text{ k}\Omega$, $C_L = 50\text{ pF}$, (Figures 2 and 3) $V_{DD} = 5\text{ V}$ $V_{DD} = 10\text{ V}$ $V_{DD} = 15\text{ V}$			125 60 50	ns ns ns
t _{PHZ} , t _{PLZ}	Propagation Delay Time Control Input to Signal Output Logical Level to High Impedance $R_L = 1.0\text{ k}\Omega$, $C_L = 50\text{ pF}$, (Figures 2 and 3) $V_{DD} = 5\text{ V}$ $V_{DD} = 10\text{ V}$ $V_{DD} = 15\text{ V}$			125 60 50	ns ns ns
	Sine Wave Distortion $V_C = V_{DD} = 5\text{ V}$, $V_{SS} = -5\text{ V}$ $R_L = 10\text{ k}\Omega$, $V_{IS} = 5\text{ V}_{p-p}$, $f = 1\text{ kHz}$, (Figure 4)		0.1		%
	Frequency Response-Switch "ON" (Frequency at -3 dB) $V_C = V_{DD} = 5\text{ V}$, $V_{SS} = -5\text{ V}$, $R_L = 1\text{ k}\Omega$, $V_{IS} = 5\text{ V}_{p-p}$, $20 \text{ Log}_{10} V_{OS}/V_{OS}(1\text{ kHz}) - \text{dB}$, (Figure 4)		40		MHz

AC Electrical Characteristics (Continued)

$T_A = 25^\circ\text{C}$, $t_r = t_f = 20\text{ ns}$ and $V_{SS} = 0\text{ V}$ unless otherwise noted

Parameter	Conditions	Min.	Typ.	Max.	Units
Feedthrough — Switch "OFF" (Frequency at -50 dB)	$V_{DD} = 5.0\text{ V}$, $V_{CC} = V_{SS} = -5.0\text{ V}$, $R_L = 1\text{ k}\Omega$, $V_{IS} = 5.0\text{ V}_{p-p}$, 20 Log_{10} , $V_{OS}/V_{IS} = -50\text{ dB}$, (Figure 4)		1.25		
Crosstalk Between Any Two Switches (Frequency at -50 dB)	$V_{DD} = V_{C(A)} = 5.0\text{ V}$; $V_{SS} = V_{C(B)} = -5.0\text{ V}$, $R_L = 1\text{ k}\Omega$, $V_{IS(A)} = 5.0\text{ V}_{p-p}$, 20 Log_{10} , $V_{OS(B)}/V_{IS(A)} = -50\text{ dB}$, (Figure 5)		0.9		MHz
Crosstalk; Control Input to Signal Output	$V_{DD} = 10\text{ V}$, $R_L = 10\text{ k}\Omega$, $R_{IN} = 1.0\text{ k}\Omega$, $V_{CC} = 10\text{ V}$ Square Wave, $C_L = 50\text{ pF}$ (Figure 6)		150		mV _{p-p}
Maximum Control Input	$R_L = 1.0\text{ k}\Omega$, $C_L = 50\text{ pF}$, (Figure 7) $V_{OS(f)} = \frac{1}{2}V_{OS}(1.0\text{ kHz})$ $V_{DD} = 5.0\text{ V}$ $V_{DD} = 10\text{ V}$ $V_{DD} = 15\text{ V}$		6.0 8.0 8.5		MHz MHz MHz
C_{IS} Signal Input Capacitance			8.0		pF
C_{OS} Signal Output Capacitance	$V_{DD} = 10\text{ V}$		8.0		pF
C_{IOS} Feedthrough Capacitance	$V_C = 0\text{ V}$		0.5		pF
C_{IN} Control Input Capacitance			5.0	7.5	pF

Note 1: "Absolute Maximum Ratings" are those values beyond which the safety of the device cannot be guaranteed. They are not meant to imply that the devices should be operated at these limits. The tables of "Recommended Operating Conditions" and "Electrical Characteristics" provide conditions for actual device operation.

Note 2: $V_{SS} = 0\text{ V}$ unless otherwise specified.

Note 3: These devices should not be connected to circuits with the power "ON".

Note 4: In all cases, there is approximately 5 pF of probe and jig capacitance in the output; however, this capacitance is included in C_L wherever it is specified.

Note 5: V_{IS} is the voltage at the in/out pin and V_{OS} is the voltage at the out/in pin. V_C is the voltage at the control input.

Note 6: Conditions for V_{IHC} :

a) $V_{IS} = V_{DD}$, $I_{OS} = \text{standard B series } I_{OH}$ b) $V_{IS} = 0\text{ V}$, $I_{OL} = \text{standard B series } I_{OL}$.

AC Test Circuits and Switching Time Waveforms

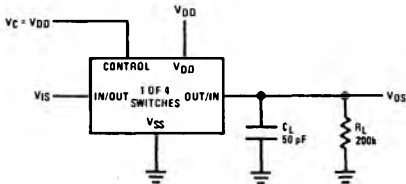

FIGURE 1. t_{pHL} , t_{pLH} Propagation Delay Time Signal Input to Signal Output

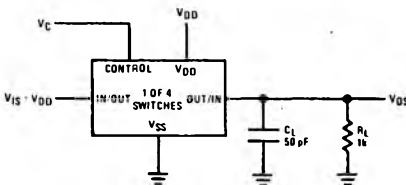
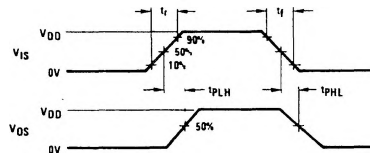

FIGURE 2. t_{pZH} , t_{pHZ} Propagation Delay Time Control to Signal Output

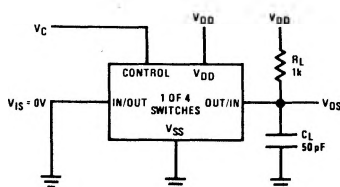
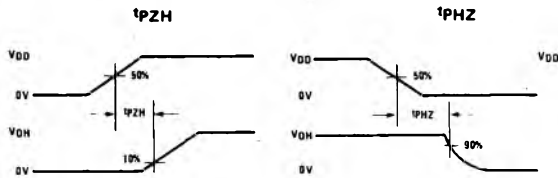
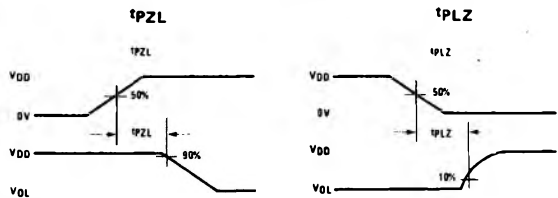
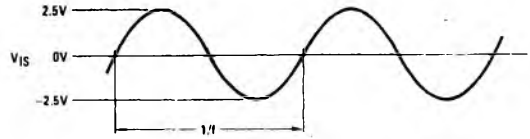
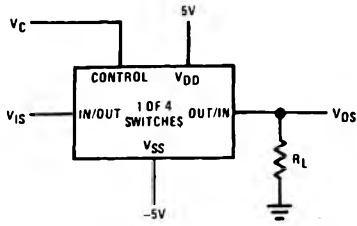

FIGURE 3. t_{pZL} , t_{pLZ} Propagation Delay Time Control to Signal Output



AC Test Circuits and Switching Time Waveforms (Cont'd.)



$V_C = V_{DD}$ for distortion and frequency response tests
 $V_C = V_{SS}$ for feedthrough test

FIGURE 4. Sine Wave Distortion, Frequency Response and Feedthrough

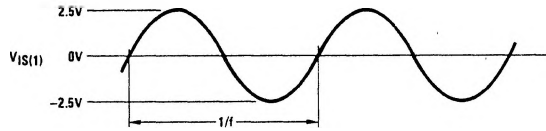
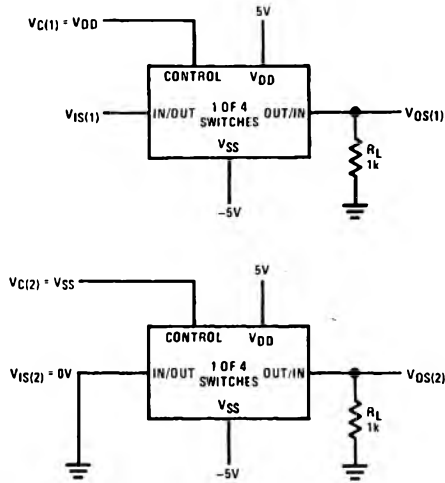

FIGURE 5. Crosstalk Between Any Two Switches

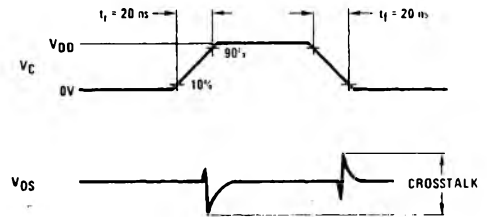
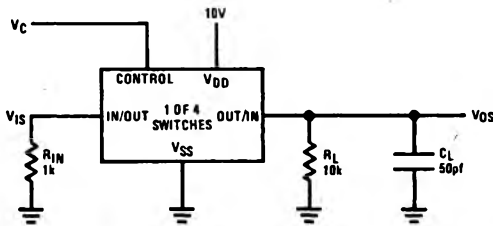

FIGURE 6. Crosstalk: Control Input to Signal Output

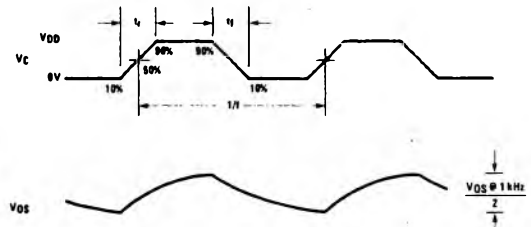
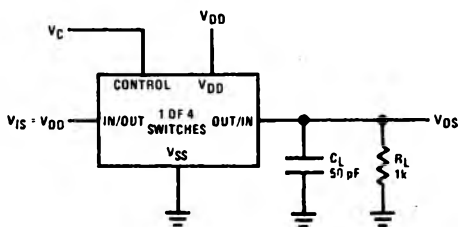
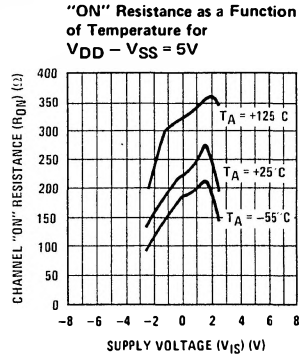
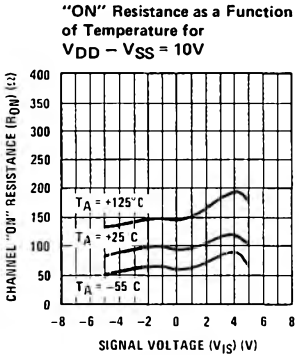
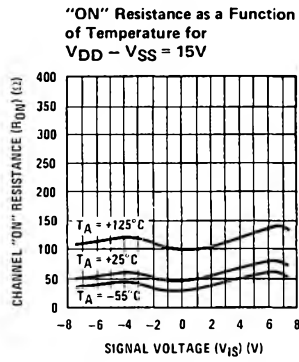
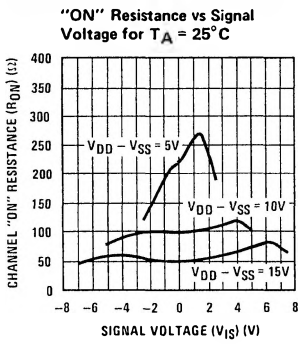

FIGURE 7. Maximum Control Input Frequency

Typical Performance Characteristics



Special Considerations

In applications where separate power sources are used to drive V_{DD} and the signal input, the V_{DD} current capability should exceed V_{DD}/R_L (R_L = effective external load of the 4 CD4066BM/CD4066BC bilateral switches). This provision avoids any permanent current flow or clamp action on the V_{DD} supply when power is applied or removed from CD4066BM/CD4066BC.

avoid drawing V_{DD} current when switch current flows into terminals 1, 4, 8 or 11, the voltage drop across the bidirectional switch must not exceed 0.6V at $T_A \leq 25^\circ\text{C}$, or 0.4V at $T_A > 25^\circ\text{C}$ (calculated from R_{ON} values shown).

In certain applications, the external load-resistor current may include both V_{DD} and signal-line components. To

No V_{DD} current will flow through R_L if the switch current flows into terminals 2, 3, 9 or 10.