



CGS3321/CGS3322 CMOS Crystal Clock Generators

General Description

These devices are designed for Clock Generation and Support (CGSTM) applications up to 110 MHz. The CGS332x series of devices are crystal controlled CMOS oscillators requiring a minimum of external components. The 332x devices provide selectable output divide ratio. The circuit is designed to operate over a wide frequency range using fundamental mode or overtone crystals.

Features

- National's CGS family of devices for high frequency clock source applications
- Crystal frequency operation range:
 - fundamental: 10 MHz to 110 MHz typical
 - 3rd or 5th overtone: 10 MHz to 95 MHz
- 1000V ESD protection on OSC_IN and OSC_OUT pins. 2000V ESD protection on all other pins
- Output current drive of 48 mA for I_{OL}/I_{OH}
- FACTM CMOS output levels
- Output has high speed short circuit protection
- Intended for Pierce oscillator applications
- Hysteresis inputs to improve noise margin
- CGS3321 has duty cycle adjust
- CGS3322 has 1, 2, 4 divide ratio

Block Diagrams

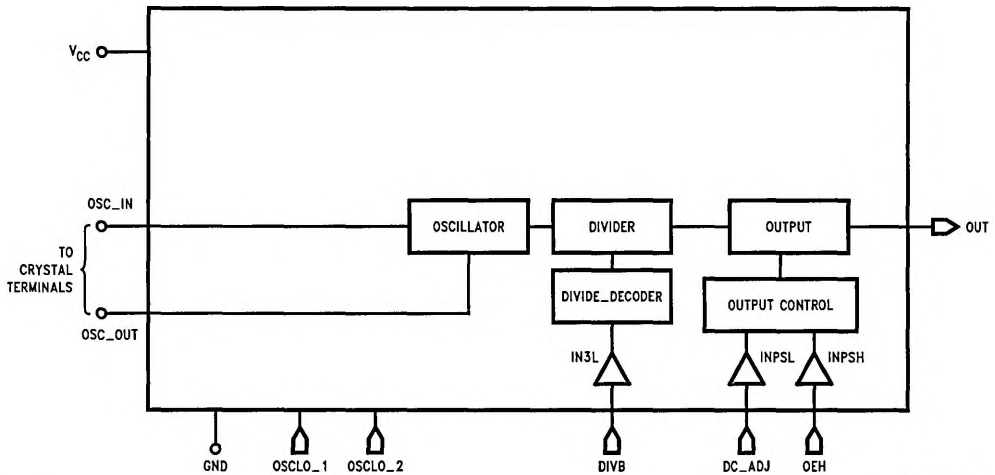

TL/F/11503-1

Note: Pin numbers vary for each device.

Block Diagrams (Continued)

CGS3321/CGS3322

Input Drivers

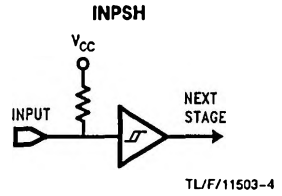
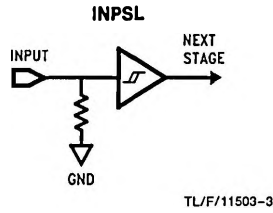
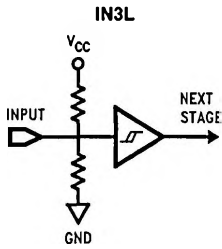

Oscillator Stage

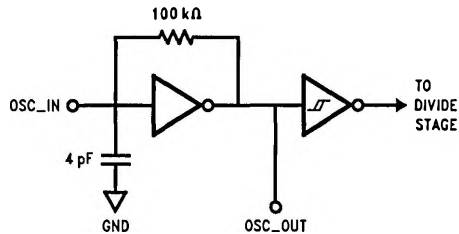

Output Stage

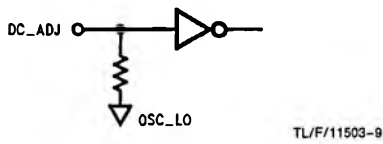
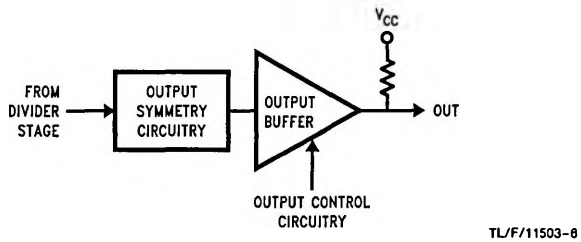

Pin Descriptions

OSC_IN Input to Oscillator Inverter. The output of the crystal would be connected here.

OSC_OUT Buffered Output of the Oscillator Inverter

DIVB (CGS3322 only)
3-Level input used to select Binary Divide-by value of output frequency.

DC_ADJ (CGS3321 only)
Active high input that controls output duty cycle. Logic high level will delay the HL transition edge approximately 0.3 ns.

Note: Pin out varies for each device.

OEH Active High TRI-STATE® enable pin. This pin pulls to a high value when left floating and TRI-STATes the output when forced low. This pin has TTL compatible input levels.

OUT This pin is the main clock output on the device.

OSCLO_1 The Oscillator Low pin is the ground for the Oscillator.

V_{CC} The power pin for the chip.

GND The ground pin for all sections of the circuitry except the oscillator and oscillator related circuitry.

Connection Diagrams

Pin Assignment for SOIC

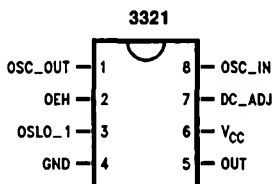

TL/F/11503-7

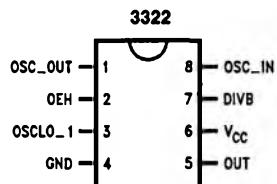

TL/F/11503-8

Truth Table

Division Selection

| DIVB | OEH | Divider Output |
|------|-----|----------------|
| F | X | Divide-by 1 |
| 1 | 1 | Divide-by 2 |
| 0 | 1 | Divide-by 4 |

Note: Actual value of the floating DIVB input is $V_{CC}/2$.

Absolute Maximum Ratings (Note)

If Military/Aerospace specified devices are required, please contact the National Semiconductor Sales Office/Distributors for availability and specifications.

| | |
|---|---------------------------|
| Supply Voltage (V_{CC}) | -0.5V to 7.0V |
| DC Input Voltage Diode Current (I_{IK}) | ± 9 mA |
| DC Input Voltage (V_I) | -0.5V to 7.0V |
| DC Output Diode Current (I_{OK}) | ± 20 mA |
| DC Output Voltage (V_O) | -0.5V to $V_{CC} + 0.5$ V |
| DC Output Source or Sink Current (I_O) | ± 70 mA |
| Storage Temperature (T_{STG}) | -55°C to +150°C |
| Junction Temperature (T_J) | SOIC 140°C/W |

Recommended Operating Conditions

| | |
|---------------------------------|------------------|
| Supply Voltage (V_{CC}) | 4.5V to 5.5V |
| Input Voltage (V_I) | 0V to 5.5V |
| Output Voltage (V_O) | 0V to V_{CC} V |
| Operating Temperature (T_A) | -40°C to +85°C |

Note: The Absolute Maximum Ratings are those values beyond which the safety of the device cannot be guaranteed. The device should not be operated at these limits. The parametric values defined in the DC and AC Electrical Characteristics tables are not guaranteed at the absolute maximum ratings. The Recommended Operating Conditions will define the conditions for actual device operation.

DC Electrical Characteristics

| Symbol | Parameter | V_{CC} (V) | CGS3321/3322 | | | | | | Units | Conditions | |
|---------------------|---|-----------------|---------------------------|------|---|------|--|------|-------|------------|-----------------------------|
| | | | $T_A = +25^\circ\text{C}$ | | $T_A = -40^\circ\text{C to } +85^\circ\text{C}$ | | $T_A = -55^\circ\text{C to } +125^\circ\text{C}$ | | | | |
| | | | Guaranteed Limits | | | | | | | | |
| Typ | Min | Max | Min | Max | Min | Max | | | | | |
| $V_{IH\text{TTL}}$ | Minimum High Level Input Voltage. TTL Level Inputs (OE \bar{H} , OEL) | 4.5 | | | 2.0 | | 2.0 | | | V | |
| | | 5.5 | | | 2.0 | | 2.0 | | | | |
| $V_{IL\text{TTL}}$ | Maximum Low Level Input Voltage. TTL Level Inputs (OE \bar{H} , OEL) | 4.5 | | | | 0.8 | | 0.8 | | V | |
| | | 5.5 | | | | 0.8 | | 0.8 | | | |
| $V_{IH\text{CMOS}}$ | Minimum High Level Input Voltage. CMOS Level Inputs (DC_ADJ) | 4.5 | | | 3.15 | | 3.15 | | | V | |
| | | 5.5 | | | 3.85 | | 3.85 | | | | |
| $V_{IL\text{CMOS}}$ | Maximum Low Level Input Voltage. CMOS Level Inputs (DC_ADJ) | 4.5 | | | | 1.35 | | 1.35 | | V | |
| | | 5.5 | | | | 1.65 | | 1.65 | | | |
| $V_{IN3_L_H}$ | Minimum Logic 1 Input for Three Level Input (DIVB) | 4.5 | | | 4.05 | | 4.05 | | | V | |
| | | 5.5 | | | 4.95 | | 4.95 | | | | |
| $V_{IN3_L_1/2}$ | Minimum Logic 1/2 Input for Three Level Input (DIVB) | 4.5 | | | 1.8 | 2.7 | 1.8 | 2.7 | | V | |
| | | 5.5 | | | 2.2 | 3.3 | 2.2 | 3.3 | | | |
| $V_{IN3_L_L}$ | Maximum Logic 0 Input Level Three Level Input (DIVB) | 4.5 | | | | 0.45 | | 0.45 | | V | |
| | | 5.5 | | | | 0.45 | | 0.45 | | | |
| V_{OH} | Minimum High Level Output Voltage | 4.5 | 4.49 | 4.40 | | 4.40 | | | | V | $I_{OUT} = -50 \mu\text{A}$ |
| | | 5.5 | 5.49 | 5.40 | | 5.40 | | | | | |
| | | 4.5 | | 3.86 | | 3.76 | | | | | |
| | | 5.5 | | 4.86 | | 4.76 | | | | | |

DC Electrical Characteristics (Continued)

| Symbol | Parameter | V _{CC} (V) | CGS3321/3322 | | | | | | Units | Conditions | |
|------------------------------|--|------------------------|------------------------|-------------------|------------------------------------|------|-------------------------------------|-----|-------|--|-----|
| | | | T _A = +25°C | | T _A = -40°C to +85°C | | T _A = -55°C to +125°C | | | | |
| | | | Typ | Guaranteed Limits | | | | | | | |
| | | | | Min | Max | Min | Max | Min | | | Max |
| V _{OL} | Minimum Low Level Output Voltage | 4.5 | 0.001 | 0.1 | | 0.1 | | | V | I _{OUT} = 50 μA | |
| | | 5.5 | 0.001 | 0.1 | | 0.1 | | | | I _{OL} = +48 mA | |
| | | 4.5 | | 0.44 | | 0.44 | | | | V _{IN} = V _{IL} or V _{IH} | |
| | | 5.5 | | 0.44 | | 0.44 | | | | | |
| I _{IHRES} | Input Current for Pins DIVB | 5.5 | | 220 | 360 | 200 | 380 | | μA | V _{IN} = 5.5V | |
| I _{ILRES} | Input Current for Pins DIVB | 5.5 | | -220 | -360 | -200 | -380 | | μA | V _{IN} = 0.0V | |
| I _{IHENAB} | Input Current for Enable Pin OEL | 5.5 | | 90 | 160 | 85 | 175 | | μA | V _{IN} = 5.5V | |
| I _{ILENAB} | Input Current for Enable pin OEH | 5.5 | | -90 | -160 | -85 | -175 | | μA | V _{IN} = 0.0V | |
| I _{IHOSC} | Input Current for OSC_IN pin (Indicates Bias Resistance) | 5.5 | | 20 | 100 | 20 | 125 | | μA | V _{IN} = 5.5V | |
| I _{ILOSC} | Input Current for OSC_IN pin (Indicates Bias Resistance) | 5.5 | | -20 | -100 | -20 | -125 | | μA | V _{IN} = 0.0V | |
| I _{OZH} | Output Disabled Current (Output High) | 4.5 | | | 3.0 | | 5.0 | | μA | V _{OUT} = V _{CC} | |
| | | 5.5 | | | 3.0 | | 5.0 | | | | |
| I _{OZL} | Output Disabled Current (Output Low) | 4.5 | | | -140 | | -150 | | μA | V _{OUT} = 0.0V | |
| | | 5.5 | | | -170 | | -180 | | | | |
| I _{OLD} | Minimum Dynamic Output Current | 5.5 | | 75 | | 75 | | | mA | V _{OLD} = 1.65V | |
| I _{OHD} | Minimum Dynamic Output Current | 5.5 | | -75 | | -75 | | | mA | V _{OHD} = 3.85V | |
| I _{CC_T} | Additional Maximum I _{CC} per Input (OEH, OEL Pins) | 5.5 | | | 1.5 | | 1.5 | | mA | V _{IN} = V _{CC} - 2.1V | |
| I _{CC_{3L}} | Additional Maximum I _{CC} per Input (DIVB) | 5.5 | | | 1.5 | | 1.5 | | mA | DIVB Inputs Equal to V _{CC} /2 | |

AC Electrical Characteristics

Over recommended operating free air temperature range. All typical values are measured at $V_{CC} = 5V$, $T_A = 25^\circ C$

| Symbol | Parameter | V_{CC}^* (V) | CGS332X | | | | | | Units |
|----------------------------|---------------------------------------|-------------------|--|-----|------|---|-----|-----|-------|
| | | | $T_A = -40^\circ C \text{ to } +85^\circ C$ $C_L = 50 \text{ pF}$ | | | $T_A = -55^\circ C \text{ to } +125^\circ C$ $C_L = 50 \text{ pF}$ | | | |
| | | | Min | Typ | Max | Min | Typ | Max | |
| f_{MAX} | Frequency Maximum | 5.0 | 95 | 110 | | | | | MHz |
| t_{pZH} | Output High Enable Time | 5.0 | 1.0 | | 31.5 | | | | ns |
| t_{pZL} | Output Low Enable Time | 5.0 | 1.0 | | 28.0 | | | | ns |
| t_{pHZ} | Output High Disable Time | 5.0 | 1.0 | | 21.5 | | | | ns |
| t_{pLZ} | Output Low Disable Time | 5.0 | 1.0 | | 16.0 | | | | ns |
| t_{rise} , t_{fall} | Rise/Fall Time (30 pF, 20% to 80%) | 5.0 | | 1.0 | | | | | ns |

*Voltage Range 5.0 is $5.0V \pm 0.5V$.