

CLC410 Fast Settling, Video Op Amp with Disable

Check for Samples: [CLC410](#)

FEATURES

- -3dB bandwidth of 200MHz
- 0.05% settling in 12ns
- Low Power, 160mW (40mW disabled)
- Low distortion, -60dBc at 20MHz
- Fast disable (200ns)
- Differential gain/phase: 0.01%/0.01°
- ± 1 to ± 8 closed-loop gain range

APPLICATIONS

- Video switching and distribution
- Analog bus driving (with disable)
- Low power “standby” using Disable
- Fast, precision A/D conversion
- D/A current-to-voltage conversion
- IF processors
- High speed communications

Figure 1. Enable/Disable Response

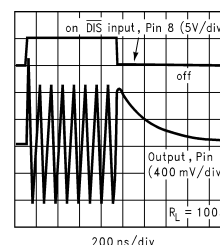

DESCRIPTION

The current-feedback CLC410 is a fast settling, wideband, monolithic op amp with fast disable/enable feature. Designed for low gain applications ($A_V = \pm 1$ to ± 8), the CLC410 consumes only 160mW of power (180mW max) yet provides a -3dB bandwidth of 200MHz ($A_V = +2$) and 0.05% settling in 12ns (15ns max). Plus, the disable feature provides fast turn on (100ns) and turn off (200ns). In addition, the CLC410 offers both high performance and stability without compensation - even at a gain of +1.

The CLC410 provides a simple, high performance solution for video switching and distribution applications, especially where analog buses benefit from use of the disable function to “multiplex” signals onto the bus. Differential gain/phase of 0.01%/0.01° provide high fidelity and the 60mA output current offers ample drive capability.

The CLC410's fast settling, low distortion, and high drive capabilities make it an ideal ADC driver. The low 160mW quiescent power consumption and very low 40mW disabled power consumption suggest use where power is critical and/or “system off” power consumption must be minimized.

The CLC410 is available in several versions to meet a variety of requirements. A three letter suffix determines the version.

Enhanced Solutions (Military/Aerospace)

SMD Number: 5962-90600

Space level versions also available.

For more information, visit <http://www.national.com/mil>



Please be aware that an important notice concerning availability, standard warranty, and use in critical applications of Texas Instruments semiconductor products and disclaimers thereto appears at the end of this data sheet.

All trademarks are the property of their respective owners.

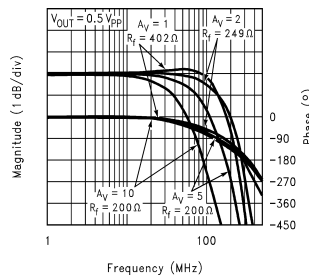
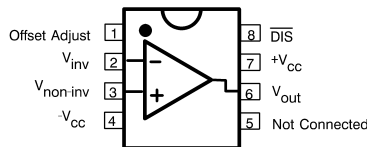
Figure 2. Non-Inverting Frequency Response**Connection Diagram****Figure 3. Pinout
DIP & SOIC**

These devices have limited built-in ESD protection. The leads should be shorted together or the device placed in conductive foam during storage or handling to prevent electrostatic damage to the MOS gates.

Absolute Maximum Ratings ⁽¹⁾

Supply Voltage (V_{CC})	$\pm 7V$
I_{OUT} Output is short circuit protected to ground, but maximum reliability will be maintained if I_{OUT} does not exceed...	60mA
Common Mode Input Voltage	$\pm V_{CC}$
Differential Input Voltage	5V
Disable Input Voltage (pin 8)	$\pm V_{CC} - 1V$
Applied output voltage when disabled	$\pm V_{CC}$
Junction Temperature	+150°C
Operating Temperature Range	-40°C to +85°C
Storage Temperature Range	-65°C to +150°C
Lead Solder Duration (+300°C)	10 sec
ESD Rating (human body model)	500V

- (1) "Absolute Maximum Ratings" are those values beyond which the safety of the device cannot be guaranteed. They are not meant to imply that the devices should be operated at these limits. The table of "Electrical Characteristics" specifies conditions of device operation.

Operating Ratings

Thermal Resistance		
Package	(θ_{JC})	(θ_{JA})
MDIP	65°C/W	120°C/W
SOIC	60°C/W	140°C/W

Electrical Characteristics

$A_V = +2$, $V_{CC} = \pm 5V$, $R_L = 100\Omega$, $R_f = 250\Omega$; unless specified

Symbol	Parameter	Conditions	Typ	Max/Min ⁽¹⁾			Units
Ambient Temperature		CLC410AJ	+25°C	-40°C	+25°C	+85°C	
Frequency Domain Response							
SSBW	-3dB Bandwidth	$V_{OUT} < 0.5V_{PP}$	200	>150	>150	>120	MHz
LSBW		$V_{OUT} < 5V_{PP}$, $A_V = +5$	50	>35	>35	>35	MHz
	Gain Flatness	$V_{OUT} < 0.5V_{PP}$					
GFPL	Peaking	DC to 40MHz	0	<0.4	<0.3	<0.4	dB
GFPH	Peaking	>40MHz	0	<0.7	<0.5	<0.7	dB
GFR	Rolloff	DC to 75MHz	0.6	<1	<1	<1.3	dB
LPD	Linear Phase Deviation	DC to 75MHz	0.2	<1	<1	<1.2	deg
Time Domain Response							
TRS	Rise and Fall Time	0.5V Step	1.6	<2.4	<2.4	<2.4	ns
TRL		5V Step	6.5	<10	<10	<10	ns
TSP	Settling Time to	$\pm 0.1\%$ 2V Step	10	<13	<13	<13	ns
TS		$\pm 0.05\%$ 2V Step	12	<15	<15	<15	ns
OS	Overshoot	0.5V Step	0	<15	<10	<10	%
SR	Slew Rate	$A_V = +2$	700	>430	>430	>430	V/ μ s
SR1		$A_V = -2$	1600	–	–	–	V/ μ s
Distortion And Noise Response							
HD2	2nd Harmonic Distortion	$2V_{PP}$, 20MHz	-60	<-40	<-45	<-45	dBc
HD3	3rd harmonic distortion	$2V_{PP}$, 20MHz	-60	<-50	<-50	<-50	dBc
	Equivalent Input Noise						
SNF	Noise Floor	>1MHz ⁽²⁾	-157	<-154	<-154	<-153	dBm (1Hz)
INV	Integrated Noise	1MHz to 200MHz ⁽²⁾	40	<54	<57	<63	μ V
DG	Differential Gain ⁽³⁾	(See Plots)	0.01	0.05	0.04	0.04	%
DP	Differential Phase ⁽³⁾	(See Plots)	0.01	0.1	0.02	0.02	deg
Disable/Enable Performance							
TOFF	Disable Time to >50dB Attenuation at 10MHz		200	<1000	<1000	<1000	ns
TON	Enable Time		100	<200	<200	<200	ns
	\overline{DIS} Voltage						
VDIS	To Disable		1.0	0.5	0.5	0.5	V
VEN	To Enable		2.6	2.3	3.2	4.0	V
	\overline{DIS} current (sourced from CLC410, see Figure 8)						
IDIS	To Disable		200	250	250	250	μ A
IEN	To Enable		80	60	60	60	μ A
OSD	Off Isolation	At 10MHz	59	>55	>55	>55	dB
Static, DC Performance							
VIO	Input Offset Voltage ⁽⁴⁾		2	< ± 8.2	< ± 5.0	< ± 9.0	mV
DVIO	average temperature coefficient		20	< ± 40	–	< ± 40	μ V/ $^{\circ}$ C
IBN	Input Bias Current ⁽⁴⁾	Non Inverting	10	< ± 36	< ± 20	< ± 20	μ A

(1) Min/max ratings are based on product characterization and simulation. Individual parameters are tested as noted. Outgoing quality levels are determined from tested parameters.

(2) Noise tests are performed from 5MHz to 200MHz.

(3) Differential gain and phase measured at: $A_V = +2$, $R_f = 250\Omega$, $R_L = 150\Omega$ 1V_{PP} equivalent video signal, 0-100 IRE, 40 IRE_{PP}, 3.58 MHz, IRE = 0 volts, at 75 Ω load. See text.

(4) AJ-level: spec. is 100% tested at +25°C, sample at 85°C.

Electrical Characteristics (continued)

$A_V = +2$, $V_{CC} = \pm 5V$, $R_L = 100\Omega$, $R_f = 250\Omega$; unless specified

Symbol	Parameter	Conditions	Typ	Max/Min ⁽¹⁾			Units
DIBN	Average Temperature Coefficient		100	< ± 200	–	< ± 100	nA/ $^{\circ}$ C
IBI	Input Bias Current ⁽⁴⁾	Inverting	10	< ± 36	< ± 20	< ± 30	μ A
DIBI	Average Temperature Coefficient		50	< ± 200	–	< ± 100	nA/ $^{\circ}$ C
PSRR	Power Supply Rejection Ratio		50	>45	>45	>45	dB
CMRR	Common Mode Rejection Ratio		50	>45	>45	>45	dB
ICC	Supply Current ⁽⁴⁾	No Load, Quiescent	16	<18	<18	<18	mA
ISD	Supply Current, Disabled	No Load, Quiescent	4	<6	<6	<6	mA
Miscellaneous Performance							
RIN	Non-Inverting Input	Resistance	200	>50	>100	>100	k Ω
CIN		Capacitance	0.5	<2	<2	<2	pF
RO	Output Impedance	At DC	0.1	<0.2	<0.2	<0.2	Ω
ROD	Output Impedance, Disabled	Resistance, at DC	200	<100	<100	<100	k Ω
COD		Capacitance, at DC	0.5	<2	<2	<2	pF
VO	Output Voltage Range	No Load	± 3.5	> ± 3	> ± 3.2	> ± 3.2	V
CMIR	Common Mode Input Range	For Rated Performance	± 2.1	> ± 1.2	> ± 2	> ± 2	V
IO	Output Current	-40° C to $+85^{\circ}$ C	± 70	> ± 35	> ± 50	> ± 50	mA
IO		-55° C to $+125^{\circ}$ C	± 60	> ± 30	> ± 50	> ± 50	mA

Typical Performance Characteristics

($T_A = 25^\circ$, $A_V = +2$, $V_{CC} = \pm 5V$, $R_L = 100\Omega$; Unless Specified).

Non-Inverting Frequency Response

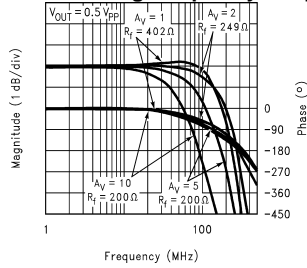

Inverting Frequency Response

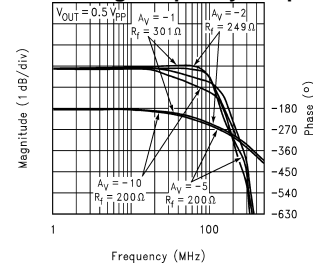

Frequency Response for Various R_L S

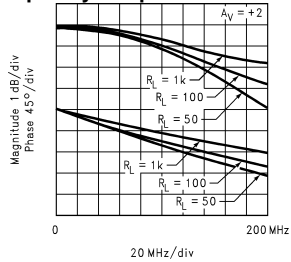

Forward and Reverse Gain During Disable

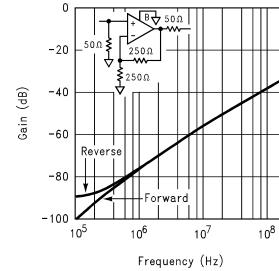

2nd and 3rd Harmonic Distortion

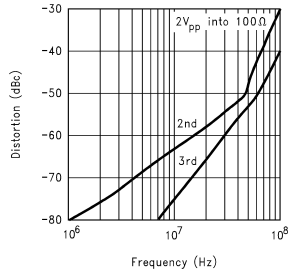

2-Tone, 3rd Order, Intermodulation Intercept

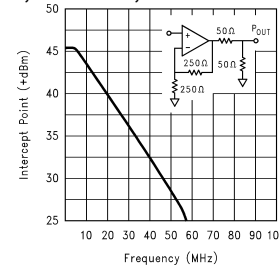

Equivalent Input Noise

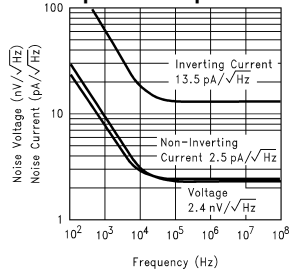

CMRR and PSRR

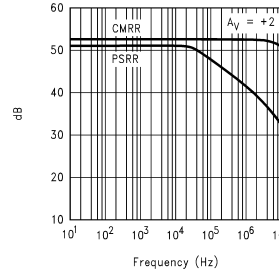

Pulse Response

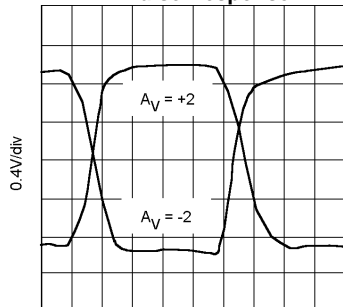

Settling Time

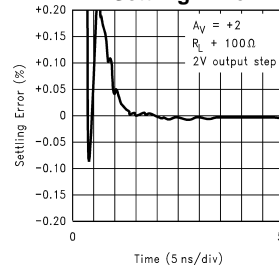

Typical Performance Characteristics (continued)

($T_A = 25^\circ$, $A_V = +2$, $V_{CC} = \pm 5V$, $R_L = 100\Omega$; Unless Specified).

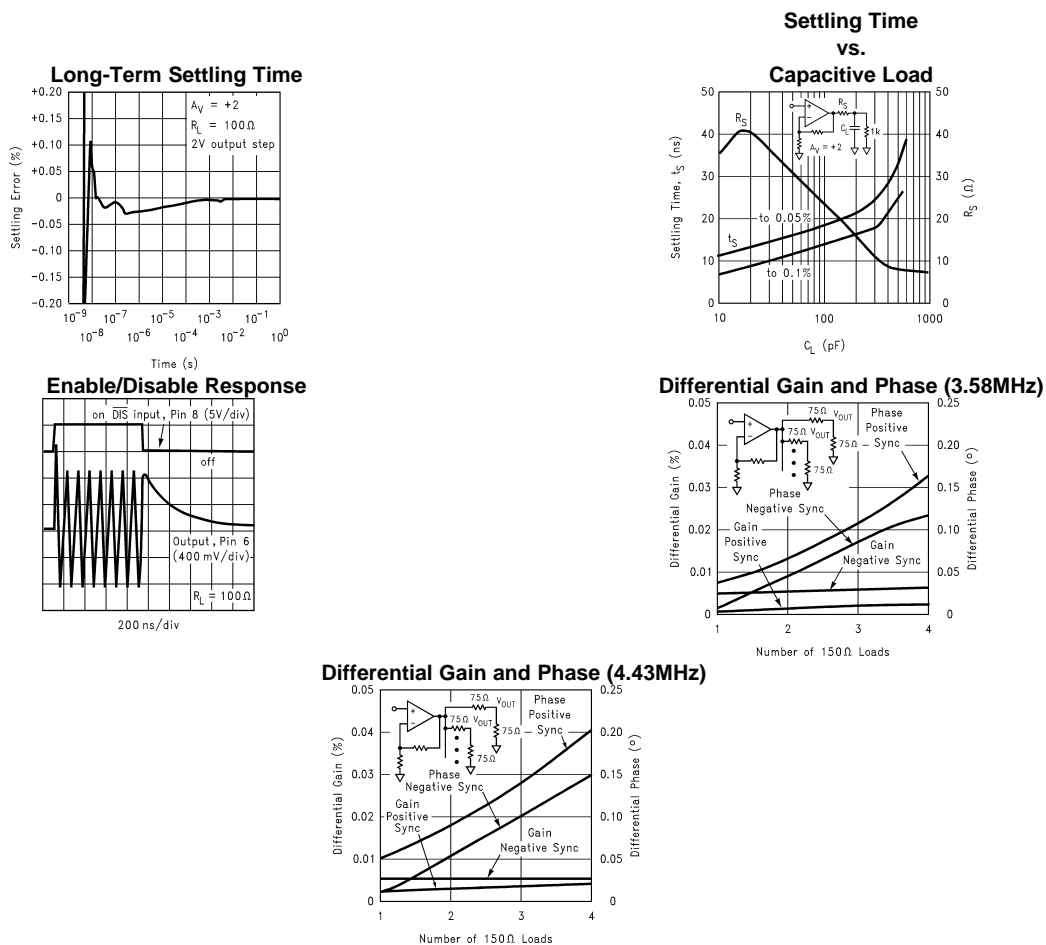

Application Division

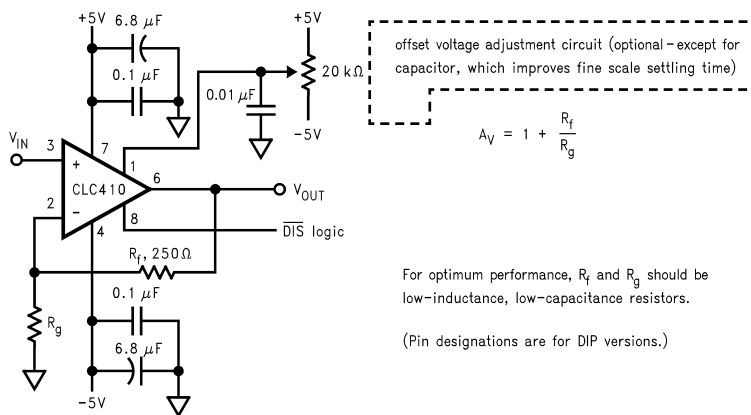

Figure 4. Recommended Non-Inverting Gain Circuit

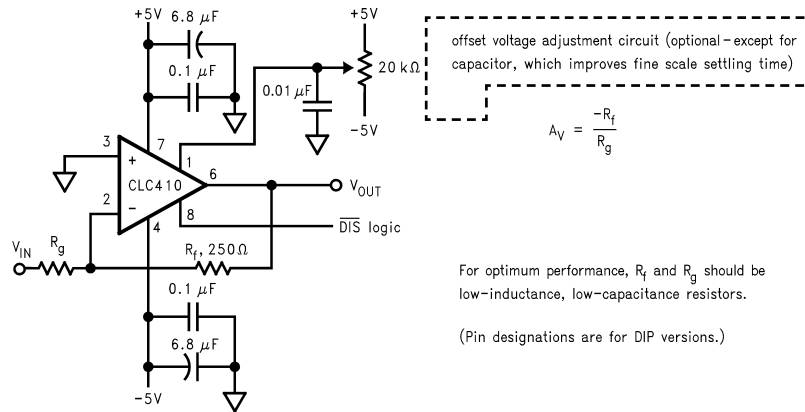

Figure 5. Recommended Inverting Gain Circuit

Enable/Disable Operation

The CLC410 has an enable/disable feature that is useful for conserving power and for multiplexing the outputs of several amplifiers onto an analog bus (Figure 6). Disabling an amplifier while not in use reduces power supply current and the output and inverting input pins become a high impedance.

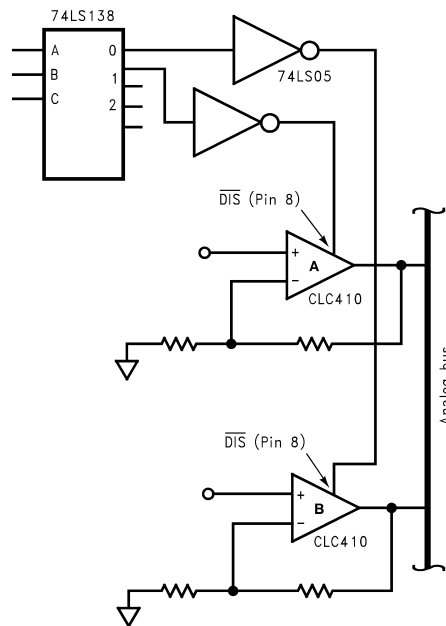
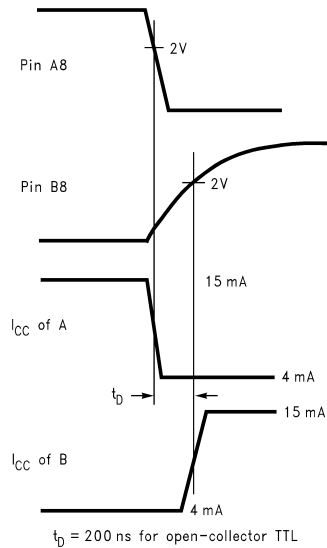
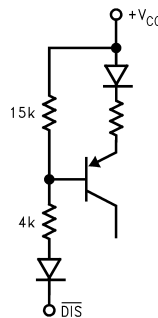

Figure 6.

**Figure 7.**

Pin 8, the $\overline{\text{DIS}}$ pin, can be driven from either open-collector TTL or from 5V CMOS. A logic low disables the amplifier and an internal $15\text{k}\Omega$ pull-up resistor ensures that the amplifier is enabled if pin 8 is not connected (Figure 8). Both TTL and 5V CMOS logic are guaranteed to drive a high enough high-level output voltage (V_{OH}) to ensure that the CLC410 is enabled. Whichever type used, “break-before-make” operation should be established when outputs of several amplifiers are connected together. This is important for avoiding large, transient currents flowing between amplifiers when two or more are simultaneously enabled. Typically, proper operation is ensured if all the amplifiers are driven from the same decoder integrated circuit because logic output rise times tend to be longer than fall times. As a result, the amplifier being disabled will reach the 2V threshold sooner than the amplifier being enabled (see t_D of Figure 7 timing diagram).

**Figure 8. Equivalent of $\overline{\text{DIS}}$ input**

During disable, supply current drops to approximately 4mA and the inverting input and output pin impedances become $200\text{k}\Omega \parallel 0.5\text{pF}$ each. The total impedance that a disabled amplifier and its associated feedback network presents to the analog bus is determined from Figure 9. For example, at a non-inverting gain of 1, the output impedance at video frequencies is $100\text{k}\Omega \parallel 1\text{pF}$ since the 250Ω feedback resistor is a negligible impedance. Similarly, output impedance is $500\Omega \parallel 0.5\text{pF}$ at a non-inverting gain of 2 (with $R_f = R_g = 250\Omega$).

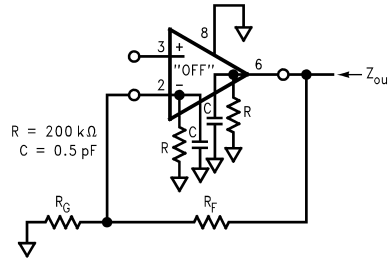

Figure 9.

Differential Gain and Phase

Plots on the preceding page illustrate the differential gain and phase performance of the CLC410 at both 3.58MHz and 4.43MHz. Application Note OA-08 presents a measurement technique for measuring the very low differential gain and phase of the CLC410. Observe that the gain and phase errors remain low even as the output loading increases, making the device attractive for driving multiple video outputs.

Understanding the Loop Gain

The CLC410 is a current-feedback op amp. Referring to the equivalent circuit of Figure 11, any current flowing in the inverting input is amplified to a voltage at the output through the transimpedance gain shown below. This Z(s) is analogous to the open-loop gain of a voltage feedback amplifier.

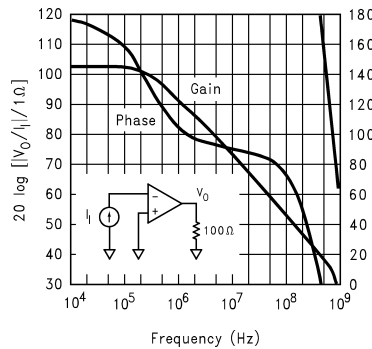

Figure 10. Open-Loop Transimpedance Gain, Z(s)

Developing the non-inverting frequency response for the topology of Figure 6 yields:

$$\frac{V_O}{V_i} = \frac{1 + R_f / R_g}{1 - 1 / LG} \tag{1}$$

where LG is the loop gain defined by,

$$LG = \frac{Z(s)}{R_f} \times \frac{1}{1 + Z_i / (R_f || R_g)} \tag{2}$$

Equation 1 has a form identical to that for a voltage feedback amplifier with the differences occurring in the LG expression, eq.2. For an idealized treatment, set Z_i = 0 which results in a very simple LG=Z(s)/R_f (Derivation of the transfer function for the case where Z_i = 0 is given in Application Note AN300-1). Using the Z(s) (open-loop transimpedance gain) plot shown on the previous page and dividing by the recommended R_f = 250Ω, yields a large loop gain at DC. As a result, Equation 1 shows that the closed-loop gain at DC is very close to (1+R_f/R_g).

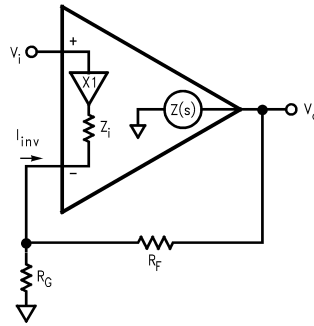

Figure 11. Current Feedback Topology

At higher frequencies, the roll-off of $Z(s)$ determines the closed-loop frequency response which, ideally, is dependent only on R_f . **The specifications reported on the previous pages are therefore valid only for the specified $R_f = 250\Omega$.** Increasing R_f from 250Ω will decrease the loop gain and bandwidth, while decreasing it will increase the loop gain possibly leading to inadequate phase margin and closed-loop peaking. Conversely, fixing R_f will hold the frequency response constant while the closed-loop gain can be adjusted using R_g .

The CLC410 departs from this idealized analysis to the extent that the inverting input impedance is finite. With the low quiescent power of the CLC410, $Z_i \approx 50\Omega$ leading to drop in loop gain and bandwidth at high gain settings, as given by equation 2. The second term in Equation 2 accounts for the division in feedback current that occurs between Z_i and $R_f \parallel R_g$ at the inverting node of the CLC410. This decrease in bandwidth can be circumvented as described in “Increasing Bandwidth at High Gains.” Also see “Current Feedback Amplifiers” in the National Databook for a thorough discussion of current feedback op amps.

Increasing Bandwidth At High Gains

Bandwidth may be increased at high closed-loop gains by adjusting R_f and R_g to make up for the losses in loop gain that occur at these high gain settings due to current division at the inverting input. An approximate relationship may be obtained by holding the LG expression constant as the gain is changed from the design point used in the specifications (that is, $R_f = 250\Omega$ and $R_g = 250\Omega$). For the CLC400 this gives,

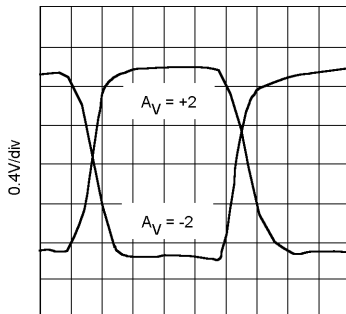

(3)

where A_V is the non-inverting gain. Note that with $A_V = +2$ we get the specified $R_f = 250\Omega$, while at higher gains, a lower value gives stable performance with improved bandwidth.

DC Accuracy and Noise

Since the two inputs for the CLC410 are quite dissimilar, the noise and offset error performance differs somewhat from that of a standard differential input amplifier. Specifically, the inverting input current noise is much larger than the non-inverting current noise. Also the two input bias currents are physically unrelated rendering bias current cancellation through matching of the inverting and non-inverting pin resistors ineffective.

In Equation 4, the output offset is the algebraic sum of the equivalent input voltage and current sources that influence DC operation. Output noise is determined similarly except that a root-sum-of-squares replaces the algebraic sum. R_s is the non-inverting pin resistance.

Equation 4

$$\text{Output Offset } V_O = \pm I_{BN} \times R_s (1 + R_f / R_g) \pm$$

$$V_{IO} (1+R_f/R_g) \pm |BI| \times R_f$$

An important observation is that for fixed R_f , offsets as referred to the input improve as the gain is increased (divide all terms by $1+R_f/R_g$). A similar result is obtained for noise where noise figure improves as a gain increases.

The input noise plot shown in the CLC400 datasheet applies equally as well to the CLC410.

Capacitive Feedback

Capacitive feedback should not be used with the CLC410 because of the potential for loop instability. See Application Note OA-7 for active filter realizations with the CLC410.

Offset Adjustment Pin

Pin 1 can be connected to a potentiometer as shown in [Figure 4](#) and used to adjust the input offset of the CLC410. Full range adjustment of $\pm 5V$ on pin 1 will yield a $\pm 10mV$ input offset adjustment range. Pin 1 should always be bypassed to ground with a ceramic capacitor located close to the package for best settling performance.

Printed Circuit Layout

As with any high frequency device, a good PCB layout will enhance performance. Ground plane construction and good power supply bypassing close to the package are critical to achieving full performance. In the non-inverting configuration, the amplifier is sensitive to stray capacitance to ground at the inverting input. Hence, the inverting node connections should be small with minimal coupling to the ground plane. Shunt capacitance across the feedback resistor should not be used to compensate for this effect.

Parasitic or load capacitance directly on the output will introduce additional phase shift in the loop degrading the loop phase margin and leading to frequency response peaking. A small series resistor before the capacitance effectively decouples this effect. The graphs on the preceding page illustrates the required resistor value and resulting performance vs. capacitance.

Precision buffed resistors (PRP8351 series from Precision Resistive Products) with low parasitic reactances were used to develop the data sheet specifications. Precision carbon composition resistors will also yield excellent results. Standard spirally-trimmed RN55D metal film resistors will work with a slight decrease in bandwidth due to their reactive nature at high frequencies.

Evaluation PC boards (part no. 730013 for through-hole and 730027 for SOIC) for the CLC404 are available.

IMPORTANT NOTICE

Texas Instruments Incorporated and its subsidiaries (TI) reserve the right to make corrections, enhancements, improvements and other changes to its semiconductor products and services per JESD46, latest issue, and to discontinue any product or service per JESD48, latest issue. Buyers should obtain the latest relevant information before placing orders and should verify that such information is current and complete. All semiconductor products (also referred to herein as "components") are sold subject to TI's terms and conditions of sale supplied at the time of order acknowledgment.

TI warrants performance of its components to the specifications applicable at the time of sale, in accordance with the warranty in TI's terms and conditions of sale of semiconductor products. Testing and other quality control techniques are used to the extent TI deems necessary to support this warranty. Except where mandated by applicable law, testing of all parameters of each component is not necessarily performed.

TI assumes no liability for applications assistance or the design of Buyers' products. Buyers are responsible for their products and applications using TI components. To minimize the risks associated with Buyers' products and applications, Buyers should provide adequate design and operating safeguards.

TI does not warrant or represent that any license, either express or implied, is granted under any patent right, copyright, mask work right, or other intellectual property right relating to any combination, machine, or process in which TI components or services are used. Information published by TI regarding third-party products or services does not constitute a license to use such products or services or a warranty or endorsement thereof. Use of such information may require a license from a third party under the patents or other intellectual property of the third party, or a license from TI under the patents or other intellectual property of TI.

Reproduction of significant portions of TI information in TI data books or data sheets is permissible only if reproduction is without alteration and is accompanied by all associated warranties, conditions, limitations, and notices. TI is not responsible or liable for such altered documentation. Information of third parties may be subject to additional restrictions.

Resale of TI components or services with statements different from or beyond the parameters stated by TI for that component or service voids all express and any implied warranties for the associated TI component or service and is an unfair and deceptive business practice. TI is not responsible or liable for any such statements.

Buyer acknowledges and agrees that it is solely responsible for compliance with all legal, regulatory and safety-related requirements concerning its products, and any use of TI components in its applications, notwithstanding any applications-related information or support that may be provided by TI. Buyer represents and agrees that it has all the necessary expertise to create and implement safeguards which anticipate dangerous consequences of failures, monitor failures and their consequences, lessen the likelihood of failures that might cause harm and take appropriate remedial actions. Buyer will fully indemnify TI and its representatives against any damages arising out of the use of any TI components in safety-critical applications.

In some cases, TI components may be promoted specifically to facilitate safety-related applications. With such components, TI's goal is to help enable customers to design and create their own end-product solutions that meet applicable functional safety standards and requirements. Nonetheless, such components are subject to these terms.

No TI components are authorized for use in FDA Class III (or similar life-critical medical equipment) unless authorized officers of the parties have executed a special agreement specifically governing such use.

Only those TI components which TI has specifically designated as military grade or "enhanced plastic" are designed and intended for use in military/aerospace applications or environments. Buyer acknowledges and agrees that any military or aerospace use of TI components which have **not** been so designated is solely at the Buyer's risk, and that Buyer is solely responsible for compliance with all legal and regulatory requirements in connection with such use.

TI has specifically designated certain components which meet ISO/TS16949 requirements, mainly for automotive use. Components which have not been so designated are neither designed nor intended for automotive use; and TI will not be responsible for any failure of such components to meet such requirements.

Products

Audio	www.ti.com/audio
Amplifiers	amplifier.ti.com
Data Converters	dataconverter.ti.com
DLP® Products	www.dlp.com
DSP	dsp.ti.com
Clocks and Timers	www.ti.com/clocks
Interface	interface.ti.com
Logic	logic.ti.com
Power Mgmt	power.ti.com
Microcontrollers	microcontroller.ti.com
RFID	www.ti-rfid.com
OMAP Applications Processors	www.ti.com/omap
Wireless Connectivity	www.ti.com/wirelessconnectivity

Applications

Automotive and Transportation	www.ti.com/automotive
Communications and Telecom	www.ti.com/communications
Computers and Peripherals	www.ti.com/computers
Consumer Electronics	www.ti.com/consumer-apps
Energy and Lighting	www.ti.com/energy
Industrial	www.ti.com/industrial
Medical	www.ti.com/medical
Security	www.ti.com/security
Space, Avionics and Defense	www.ti.com/space-avionics-defense
Video and Imaging	www.ti.com/video

TI E2E Community

e2e.ti.com