

SONY®**CXA1122AP****VTR RF Modulator****Description**

CXA1122AP is a VTR RF modulator for the VHF band, and is used to convert frequencies of audio signals and video signals.

This modulator consists of circuits such as video clamp, white clipping, a carrier oscillator, video modulator, audio FM modulator, frequency/channel switch, and antenna switch driver.

Features

- Operates with low voltage and low consumption power. ($V_{cc} = 5\text{ V}$, $I_{cc} = 17.5\text{ mA}$, $I_{cont} = 20\text{ to }25\text{ mA}$)
- Low radiation and harmonic products.
- Provided with few external devices.
- Permits two channels in the VHF band.
- Provided with a built-in regulator and is resistant to power source changes.
- Allows video input of 0.5 V_{p-p} and various uses.
- Supports a one-mixer system to simplify the RF unit design.
- Permits the signal ratio of video to audio to be adjusted with an external capacitor.
- Provided with a carrier-off SW function for boss audio.
- Has a built-in antenna switch driver.
- Has a wide oscillation margin for a SAW (Surface Acoustic Wave) resonator.

Package Outline

Unit: mm

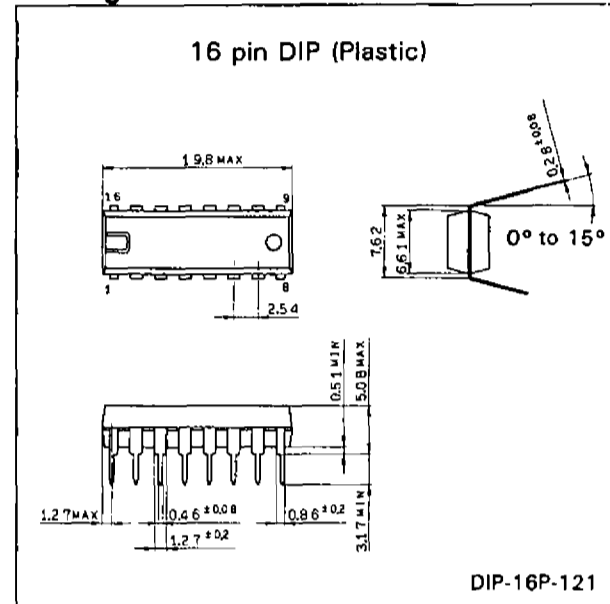
**Absolute Maximum Ratings ($T_a = 25^\circ\text{C}$)**

- Supply voltage V_{cc} 12 V
- Operating temperature T_{opr} $-20\text{ to }+75^\circ\text{C}$
- Storage temperature T_{stg} $-55\text{ to }+150^\circ\text{C}$
- Allowable power P_D 550 mW dissipation

Recommended Operating Condition

- Supply voltage V_{cc} 4.4 to 9.3 V

Structure

Bipolar silicon monolithic IC

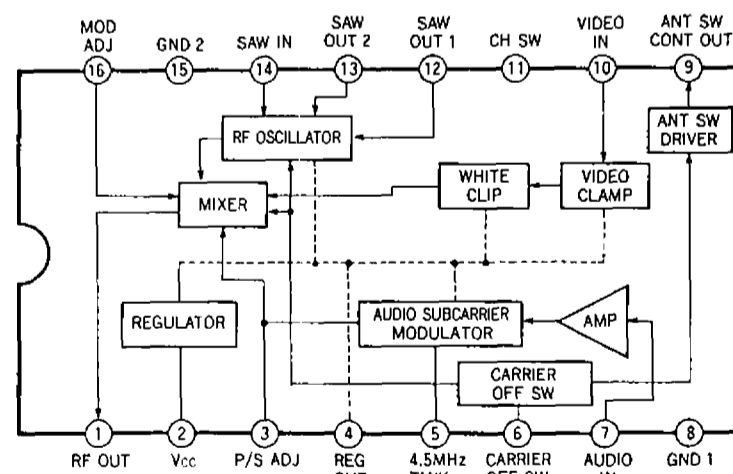
Block Diagram

- 1 -

SONY reserves the right to change products and specifications without notice.
This information does not convey any license under patent rights of SONY corporation or others.

E89127-TO

Pin Description and Equivalent Circuits

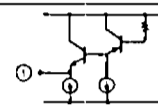
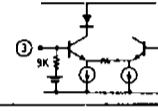
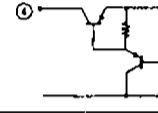
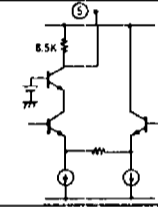
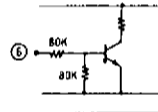
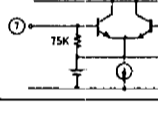
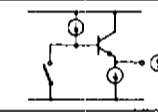
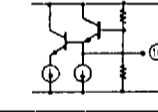
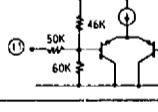
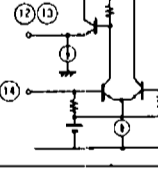
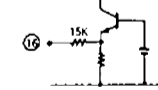
No.	Symbol	Voltage typical value (V)	Equivalent circuit	Description	
1	RF OUT	2.9		RF output pin (modulates video and audio FM signals into AM signals and outputs them.)	
2	Vcc			Vcc supply voltage pin	
3	P/S ADJ	1.8		P/S adjustment pin (The signal ratio of video to audio gets larger as capacitance is added between pin 3 and GND.)	
4	REG OUT	3.95		Regulator output pin.	
5	4.5 MHz TANK	3.05		Audio tank coil connecting pin	
6	CARRIER OFF SW	0		Carrier off switch (OPEN → carrier OFF, Vcc → carrier ON) The RF output can be switched to ON or OFF with the high-impedance input switch.	
7	AUDIO IN	1.95		Audio input pin	
8	GND1				
9	ANT SW DRIVER	4.0		Links up with pin 6 switch to supply the DC voltage output to the antenna switch circuit.	ON
		0			OFF
10	VIDEO IN	2.6		Video input pin	
11	CH SW	2.3		Channel switch OPEN ↔ GND	
					LOW 0 to 0.7V High 2.3 to Vcc
12	SAW OUT1	4.4, 3.7		Output 1 SAW resonator	
13	SAW OUT2	3.7, 4.4		Output 2 SAW resonator	
14	SAW IN	2.5		Input SAW resonator	
15	GND2				
16	MOD ADJ	0.80		Pin for slightly adjusting the modulation depth.	

Electrical Characteristics 1

(See the Electrical Characteristics Test Circuit)
Ta = 25°C, Vcc = 5 V

Item	Symbol	Test condition	Min.	Typ.	Max.	Unit
Supply current 1	Icc1	Pin 6 = High	14	17.5	22	mA
Supply current 2	Icc2	Pin 6 = Low	7.5	9.5	12	mA
ANT SW CONT	Icont	Pin 6 = High, Icont = 25 mA load	3.7	4.0	4.3	V
Video output level	Vo(fp1)	V1 = No input	85.5	88.0	90.5	dBμ
	Vo(fp2)	Vo1 output level *1				
Video output level temperature stability	ΔVo(fp1)	Vo(fp1) (Ta = -10 to +70°C) - Vo(fp1) (Ta = 25°C)	-	-	±2	dB
	ΔVo(fp2)	Vo(fp2) (Ta = -10 to +70°C) - Vo(fp1) (Ta = 25°C)	-	-	±2	dB
Video modulation depth	mp1	V1 = 0.5 Vp-p WHITE	72	78	84	%
	mp2	Vo modulation depth				
Video modulation depth temperature stability	Δmp1	mp1 (Ta = -10 to +70°C) - mp1 (Ta = 25°C)	-	-	±2.5	%
	Δmp2	mp2 (Ta = -10 to +70°C) - mp2 (Ta = 25°C)	-	-	±2.5	%
Video modulation depth difference between channels	Δmp	mp1 - mp2	-	±0.2	±2	%
Maximum video modulation depth	Δmp2 (Max.)	V1 = 1.0Vp-p, WHITE Vo modulation depth *2	11.5	15.0	18.5	%
920 kHz beat	Vb	V1 = 0.5 Vp-p sin 3.58-MHz input *3	64	70	-	dB
Sync-crush level	ΔSync	V1 = 0.5Vp-p, WHITE Vo output $1 - \{(V \text{ Sync}/V \text{ White}) \times 100\}$	-	-	10	%
Differential gain	DG1	V1 = 0.5Vp-p, STAIR STEP	-	1	3	%
	DG2	Vo DG *4				
Differential phase	DP1	V1 = 0.5Vp-p, STAIR STEP	-	2	5	deg
	DP2	Vo DP *4				
Video higher-harmonic wave ratio	VvH	V1 = 0.5Vp-p, 1 MHz CW *5	-	-56	-46	dB
RF carrier ratio of video to audio	Vps	V1 = no Video Signal, C1 = 3pF	11.5	13.5	15.5	dB
Audio FM Central frequency temperature stability	Δfs	S1 = 1, Fs = Vo2 frequency fs(Ta = 0 to 60°C) - fs(Ta = 25°C) *6				
Audio FM modulation sensitivity *	βS	S1 = 1, C2 = 39pF V2 = pin 7 DC voltage ±0.2 V fs frequency change/0.4 V *7	0.445	0.555	0.665	kHz/mV
Audio total harmonic distortion ratio	THD	S1 = 1, V2 = 1 kHz *8	-	0.30	0.8	%
Audio S/N	ASN	The audio S/N is 0 dB at 60% modulation	55	59	-	dB
Maximum audio FM modulation depth	ms(Max.)	S1 = 1, V2 = pin 7 DC voltage ±1.0V FS frequency change/50 kHz × 100	400	-	-	%

* Classifications

Marking	Audio FM modulation sensitivity (kHz/mV)
A1122AP-3	0.665 to 0.577
A1122AP-1	0.595 to 0.515
A1122AP-2	0.533 to 0.445

Electrical Characteristics 2 (Design security items: This parameter is not 100% tested.)

1. Video S/N	Min. 50 dB Typ. 58 dB
2. Video amplitude frequency characteristic (based on 1 MHz)	Within ± 1 dB for 0.5 to 5 MHz
3. Audio amplitude frequency characteristic (based on 1 kHz)	Within ± 1 dB for 0.1 to 60 kHz

- Note) *1.** Measure the V_o output level using the spectrum analyzer with a 50Ω input impedance and convert measured value V_o into decibels (dBm) using the following expression:
Output (dB μ) = V_o (dBm) + 113
- *2.** The difference in image modulation depth between the maximum modulation depth at an input of 0.5 Vp-p and at an input of 1.0 Vp-p.
- *3.** Directly-read value (dB) of the component ratio of the 920 kHz beat to the video carrier level measured with a spectrum analyzer
- *4.** Measured with the standard-type demodulator after demodulation.
- *5.** $f_c + 2$ MHz or $f_c + 3$ MHz level to the V_o carrier (f_c) level
- *6.** Adjust f_s to 4.500 MHz with $T_a = 25^\circ\text{C}$.
- *7.** A 15 k Ω resistor is added in series for pre-emphasis so that a better match can be obtained between audio modulation sensitivity classifications.
- *8.** Adjust the V_2 level so that the FM deviation is ± 15 kHz and measure the total harmonic distortion after demodulating V_o with the standard-type demodulator.

Input Waveforms

WHITE signal

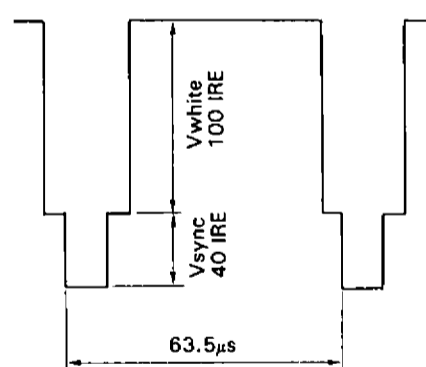

STAIR STEP signal

APL 50% subcarrier 20 IRE

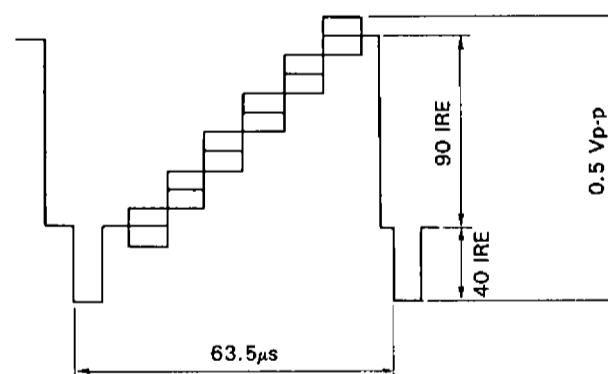

Electrical Characteristics Test Circuit

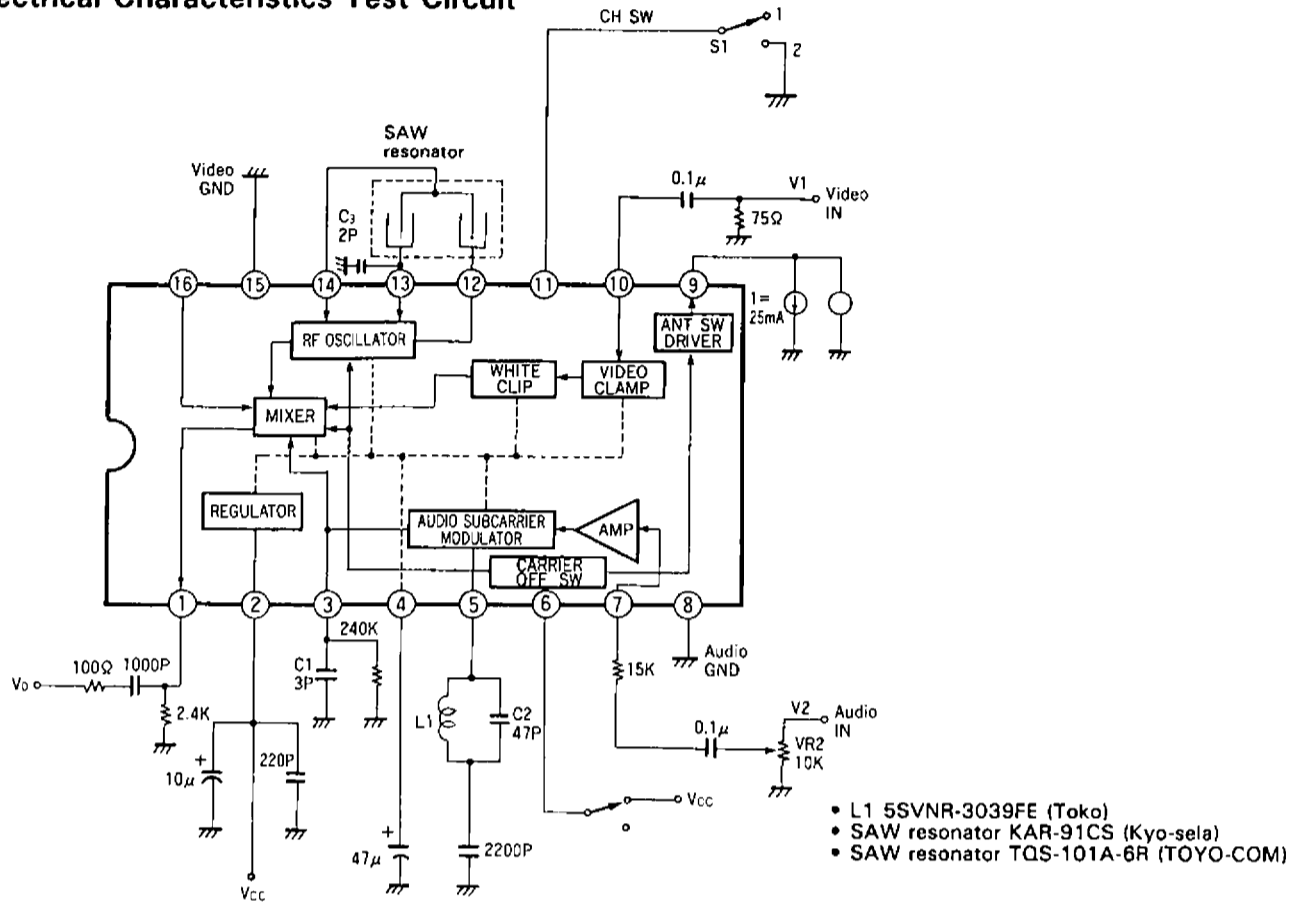

Application Circuit

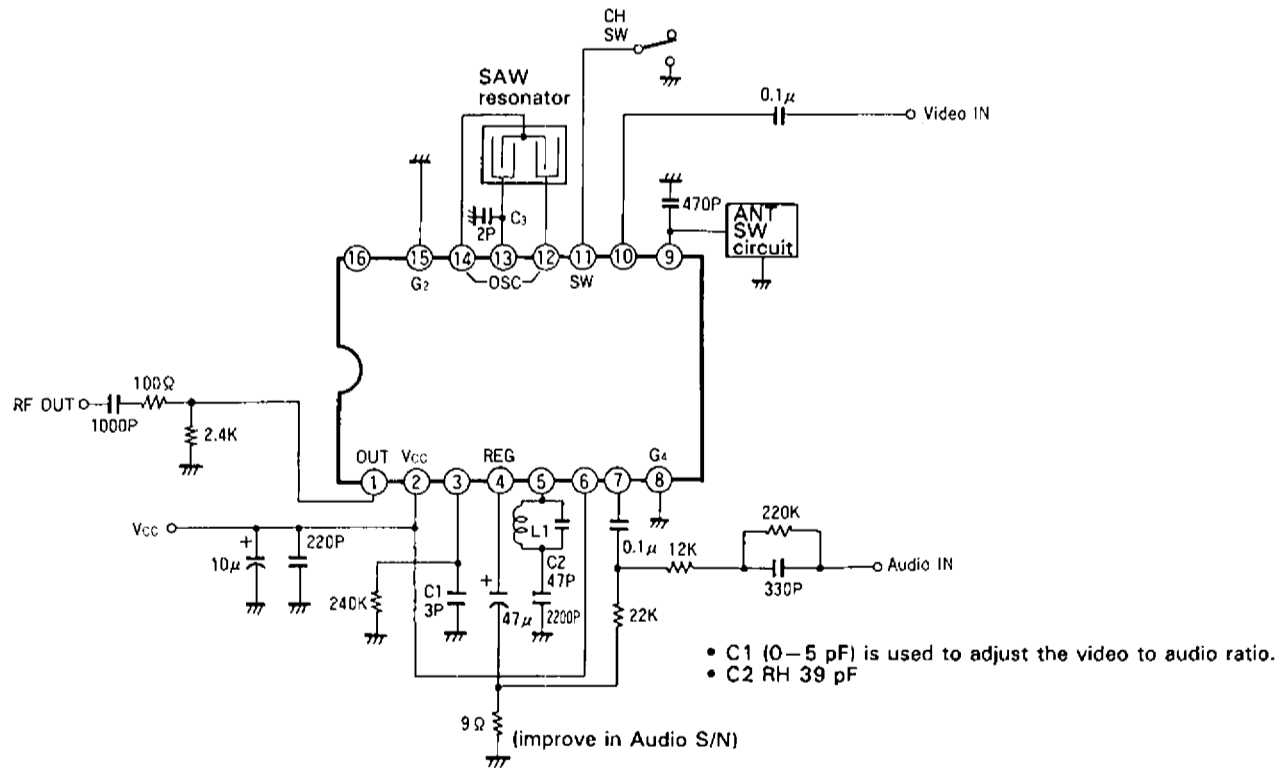

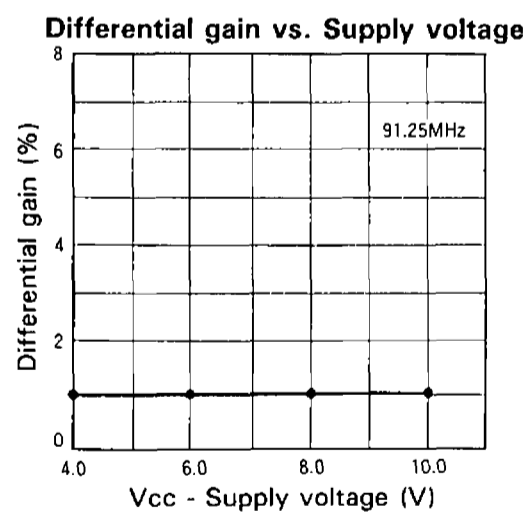
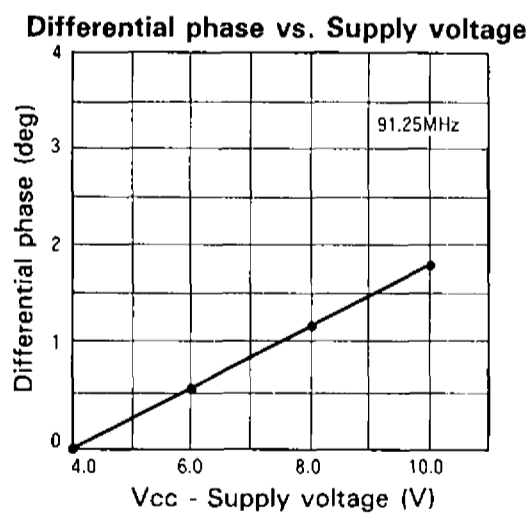
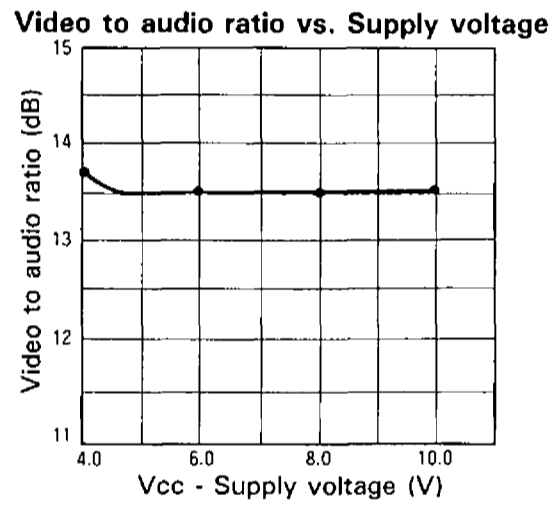
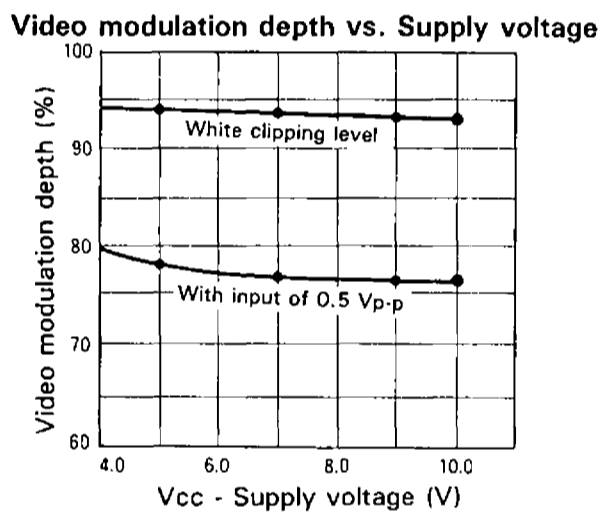
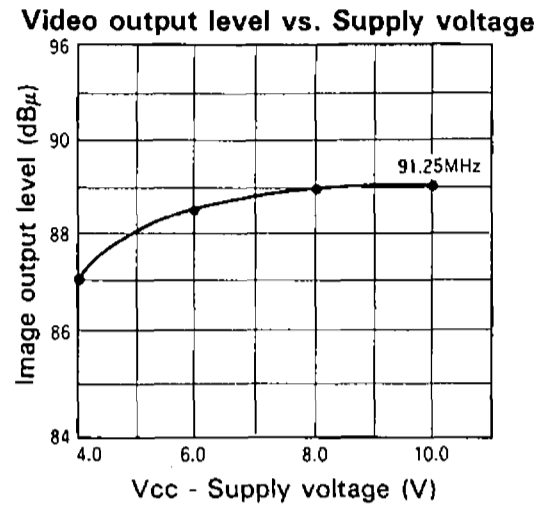
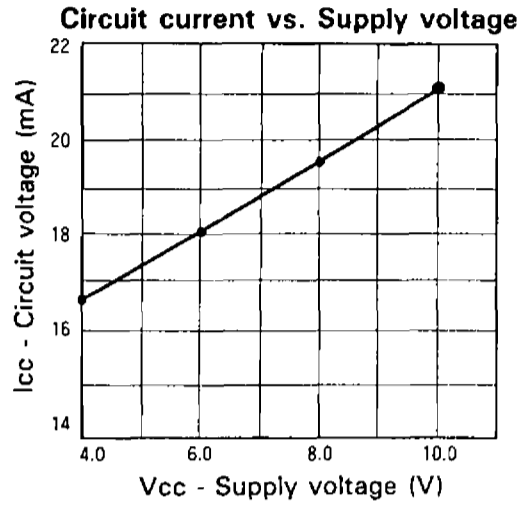

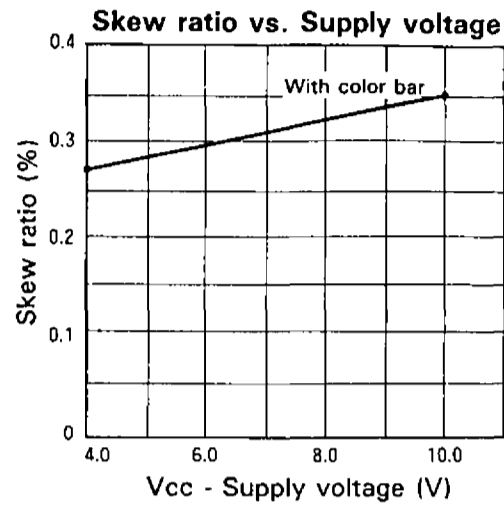
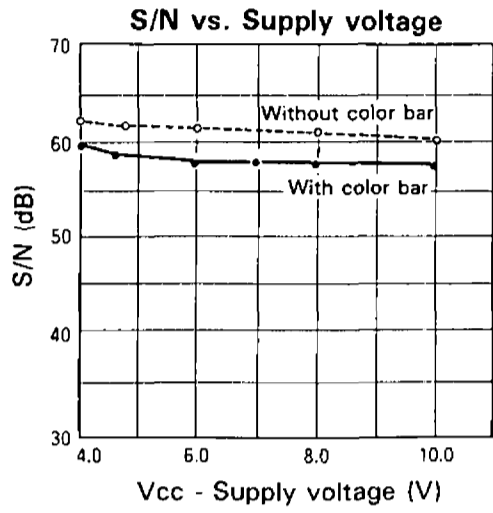

ANT SW driver load vs. Voltage characteristic

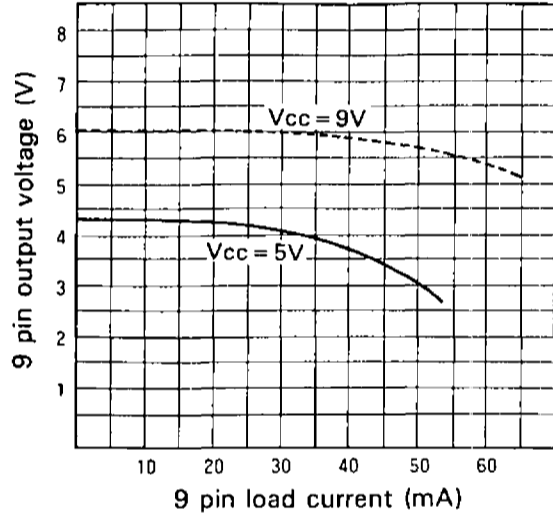

920 kHz beat vs. Supply voltage

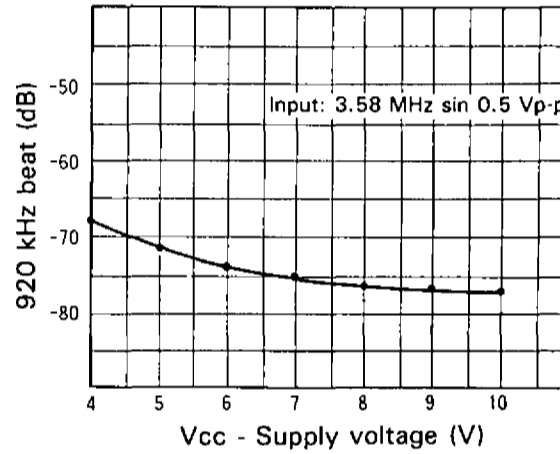

Inter-carrier change vs. Supply voltage

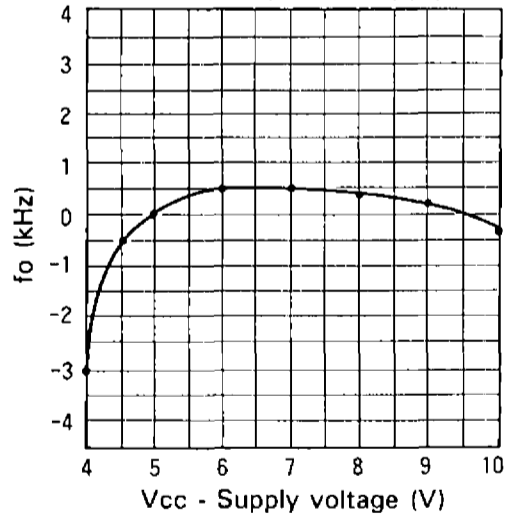

Supply ripple characteristics

