

LCD Signal Processor (Gamma Correction)

Description

The CXA2111R is a signal processor IC developed for LCD panels. Gamma correction, gain and bias, etc., can be adjusted using the I²C bus and external adjustment pins. The output of this IC is ideal as the input of the CXA2112R (LCD sample-and-hold driver IC), and the sample-and-hold position, etc., can also be adjusted using the I²C bus.

Features

- Independent R, G and B gamma adjustment
- Three-point gamma gain and position adjustment (one white side point, two black side points)
- Independent R, G and B output amplifier gain and bias adjustment
- Various I²C bus-based controls and adjustment of various characteristics by external DC input
- Input signal clamp function (variable clamp voltage)
- Black side limiter adjustment
- CXA2112R adjustment output
- Precharge output (for CXA2112R)
- High frequency response
- High slew rate output

Applications

- Liquid crystal projectors
- Compact liquid crystal monitors

Structure

Bipolar silicon monolithic IC

52 pin LQFP (Plastic)

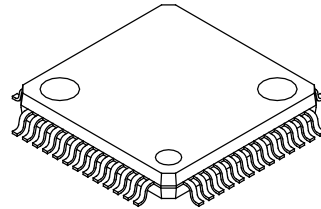

Absolute Maximum Ratings

- | | | | |
|-------------------------------|-----------|------------------------|----|
| • Supply voltage | V_{CC} | -0.3 to +5.5 | V |
| • Input voltage | V_I | -0.3 to $V_{CC} + 0.3$ | V |
| • Storage temperature | T_{stg} | -65 to +150 | °C |
| • Allowable power dissipation | P_D | 1000 | mW |

Operating Conditions

- | | | | |
|------------------------------|-----------|-----------------|---|
| • Supply voltage | V_{CC} | 4.75 to 5.25 | V |
| • Digital input voltage high | V_H | 2.2 to V_{CC} | V |
| • Digital input voltage low | V_L | 0 to 0.8 | V |
| • Operating temperature | T_{opr} | -20 to +70 | V |

Sony reserves the right to change products and specifications without prior notice. This information does not convey any license by any implication or otherwise under any patents or other right. Application circuits shown, if any, are typical examples illustrating the operation of the devices. Sony cannot assume responsibility for any problems arising out of the use of these circuits.

Pin Configuration and Block Diagram

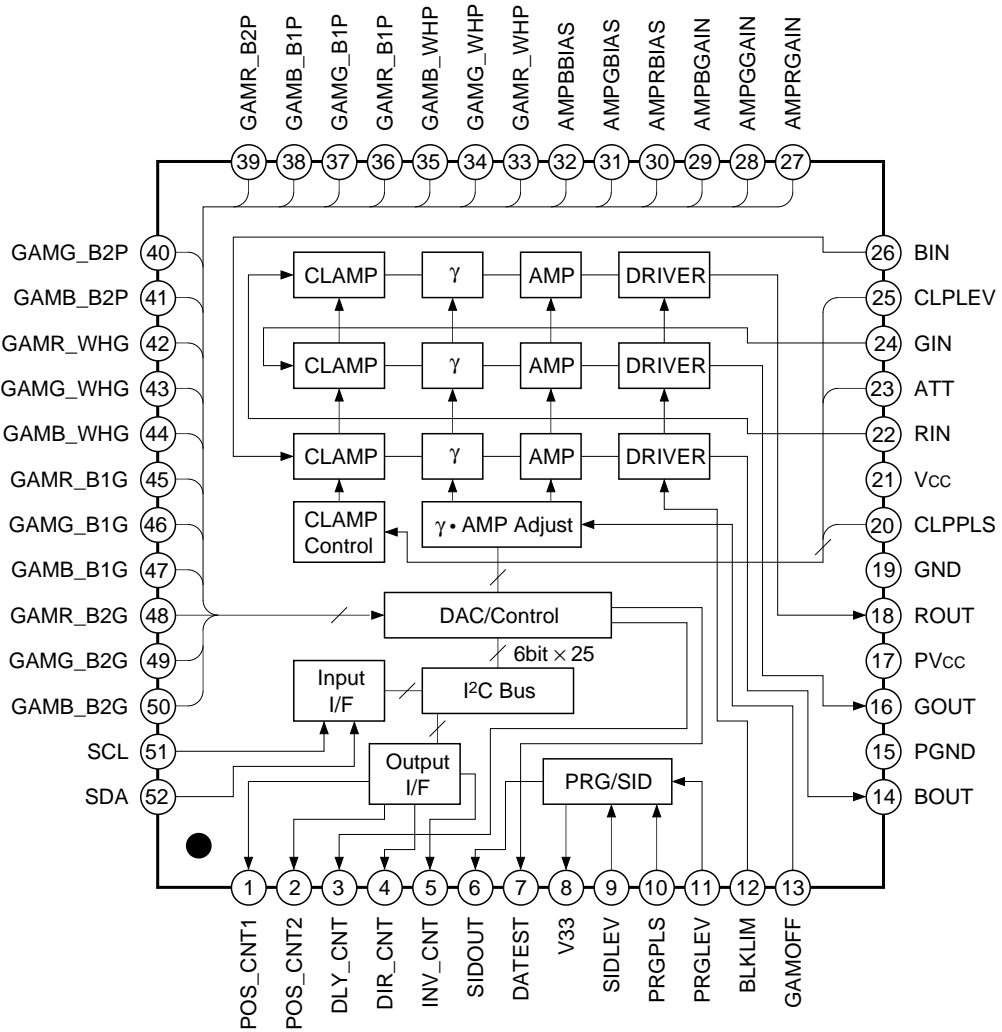

Pin Description

Pin No.	Symbol	I/O	Typical pin voltage	Equivalent circuit	Description										
1	POS_CNT1	O	0 to 5V (4 value)		<p>CXA2112R control. The sample-and-hold position is determined by the I²C data. POS_CNT1 is the low-order 4-value output and POS_CNT2 is the high-order 4-value output for a total of 16-value control.</p> <table border="1"> <thead> <tr> <th>I²C data input (2 bits)</th> <th>Pin output</th> </tr> </thead> <tbody> <tr> <td>00</td> <td>L</td> </tr> <tr> <td>01</td> <td>↓</td> </tr> <tr> <td>10</td> <td>↓</td> </tr> <tr> <td>11</td> <td>H</td> </tr> </tbody> </table>	I ² C data input (2 bits)	Pin output	00	L	01	↓	10	↓	11	H
I ² C data input (2 bits)	Pin output														
00	L														
01	↓														
10	↓														
11	H														
2	POS_CNT2														
3	DLY_CNT	O	3 to 5V		<p>CXA2112R control. The clock delay time is controlled by output analog value using I²C data.</p> <table border="1"> <thead> <tr> <th>I²C data input (6 bits)</th> <th>Pin output</th> </tr> </thead> <tbody> <tr> <td>all 0</td> <td>5V</td> </tr> <tr> <td>↓</td> <td>↓</td> </tr> <tr> <td>all 1</td> <td>3V</td> </tr> </tbody> </table>	I ² C data input (6 bits)	Pin output	all 0	5V	↓	↓	all 1	3V		
I ² C data input (6 bits)	Pin output														
all 0	5V														
↓	↓														
all 1	3V														
4	DIR_CNT	O	L/H (0V/5V)		<p>CXA2112R control. The scan direction is determined by the I²C data.</p> <table border="1"> <thead> <tr> <th>I²C data input (1 bit)</th> <th>Pin output</th> </tr> </thead> <tbody> <tr> <td>0</td> <td>H</td> </tr> <tr> <td>1</td> <td>L</td> </tr> </tbody> </table>	I ² C data input (1 bit)	Pin output	0	H	1	L				
I ² C data input (1 bit)	Pin output														
0	H														
1	L														
5	INV_CNT				<p>CXA2112R control. The clock polarity is determined by the I²C data.</p> <table border="1"> <thead> <tr> <th>I²C data input (1 bit)</th> <th>Pin output</th> </tr> </thead> <tbody> <tr> <td>0</td> <td>H</td> </tr> <tr> <td>1</td> <td>L</td> </tr> </tbody> </table>	I ² C data input (1 bit)	Pin output	0	H	1	L				
I ² C data input (1 bit)	Pin output														
0	H														
1	L														
6	SIDOUT	O	2.3 to 3.3V		<p>Output for CXA2112R. This pin outputs the precharge signal.</p> <table border="1"> <thead> <tr> <th>Pin 10 input</th> <th>Pin 6 output</th> </tr> </thead> <tbody> <tr> <td>H</td> <td>Level controlled by Pin 11</td> </tr> <tr> <td>L</td> <td>Level controlled by Pin 9</td> </tr> </tbody> </table>	Pin 10 input	Pin 6 output	H	Level controlled by Pin 11	L	Level controlled by Pin 9				
Pin 10 input	Pin 6 output														
H	Level controlled by Pin 11														
L	Level controlled by Pin 9														
7	DATEST				<p>DAC test output. Set the I²C data to "1". This pin is normally open.</p>										

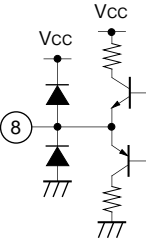
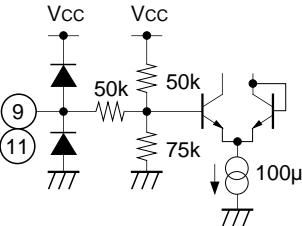
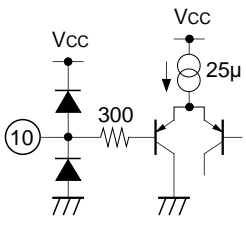
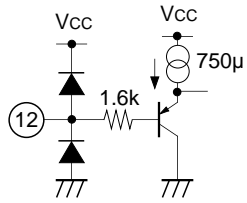
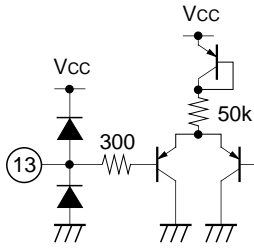
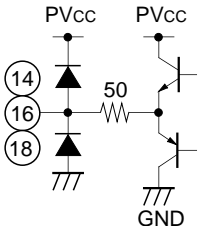
Pin No.	Symbol	I/O	Typical pin voltage	Equivalent circuit	Description													
8	V33	O	3.3V		Output for CXA2112R. This pin outputs 3.3V.													
9	SIDLEV	I	0 to 5V		These pins determine the Pin 6 output level. See Pin 6.													
11	PRGLEV																	
10	PRGPLS	I	L/H L: 0 to 0.8V H: 2.2 to 5V		This pin determines the Pin 6 output. See Pin 6. Set to low or high when using SIDOUT (Pin 6) as a DC output.													
12	BLKLIM	I	1 to 5V		Output black level (low level side) limit voltage control. Apply voltage of 1V DC or more.													
13	GAMOFF	I	L/H L: 0 to 0.8V H: 2.2 to 5V		Gamma characteristics ON/OFF setting. <table border="1" data-bbox="989 1444 1428 1646"> <thead> <tr> <th>I²C data input (1bit)</th> <th>Pin 13 input</th> <th>γ mode</th> </tr> </thead> <tbody> <tr> <td rowspan="2">0</td> <td>H</td> <td>γ ON</td> </tr> <tr> <td>L</td> <td>γ OFF</td> </tr> <tr> <td rowspan="2">1</td> <td>H</td> <td>γ OFF</td> </tr> <tr> <td>L</td> <td>γ OFF</td> </tr> </tbody> </table>	I ² C data input (1bit)	Pin 13 input	γ mode	0	H	γ ON	L	γ OFF	1	H	γ OFF	L	γ OFF
I ² C data input (1bit)	Pin 13 input	γ mode																
0	H	γ ON																
	L	γ OFF																
1	H	γ OFF																
	L	γ OFF																
14	BOUT	O	1.8 to 3.3V		B channel output.													
16	GOUT				G channel output.													
18	ROUT				R channel output.													
15	PGND		GND		GND.													
17	PVcc		5V		5V													
19	GND		GND		GND.													

Pin No.	Symbol	I/O	Typical pin voltage	Equivalent circuit	Description												
20	CLPPLS	I	L/H L: 0 to 0.8V H: 2.2 to 5V		<p>Input signal clamp pulse input. Set to low when not using the clamp function.</p> <table border="1"> <thead> <tr> <th>Pin input</th> <th>Clamp function</th> </tr> </thead> <tbody> <tr> <td>H</td> <td>ON</td> </tr> <tr> <td>L</td> <td>OFF</td> </tr> </tbody> </table>	Pin input	Clamp function	H	ON	L	OFF						
Pin input	Clamp function																
H	ON																
L	OFF																
21	Vcc		5V		5V												
22	RIN	I	1.5 to 3.5V		R channel input.												
24	GIN				G channel input.												
26	BIN				B channel input.												
23	ATT	I	L/H L: 0 to 0.8V H: 2.2 to 5V		<p>Input signal gain control. This pin also supports 2Vp-p input.</p> <table border="1"> <thead> <tr> <th>Pin input</th> <th>Clamp block gain</th> <th>Signal level</th> </tr> </thead> <tbody> <tr> <td>H</td> <td>0dB</td> <td>For 1Vp-p</td> </tr> <tr> <td>L</td> <td>-6dB</td> <td>For 2Vp-p</td> </tr> </tbody> </table>	Pin input	Clamp block gain	Signal level	H	0dB	For 1Vp-p	L	-6dB	For 2Vp-p			
Pin input	Clamp block gain	Signal level															
H	0dB	For 1Vp-p															
L	-6dB	For 2Vp-p															
25	CLPLEV	I	0 to 5V		<p>Clamp voltage control during clamp operation.</p> <table border="1"> <thead> <tr> <th>Pin input</th> <th>Clamp voltage</th> </tr> </thead> <tbody> <tr> <td>5V</td> <td>2.5V</td> </tr> <tr> <td>↓</td> <td>↓</td> </tr> <tr> <td>2.5V (open)</td> <td>2.0V</td> </tr> <tr> <td>↓</td> <td>↓</td> </tr> <tr> <td>0V</td> <td>1.5V</td> </tr> </tbody> </table>	Pin input	Clamp voltage	5V	2.5V	↓	↓	2.5V (open)	2.0V	↓	↓	0V	1.5V
Pin input	Clamp voltage																
5V	2.5V																
↓	↓																
2.5V (open)	2.0V																
↓	↓																
0V	1.5V																
27	AMPRGAIN	I	0 to 5V		<p>Amplifier gain control. Independent control for R, G and B. Equivalent to 2.5V input when open.</p>												
28	AMPGGAIN																
29	AMPBGAIN																
30	AMPRBIAS				<p>Amplifier bias control. Independent control for R, G and B. Equivalent to 2.5V input when open.</p>												
31	AMPGBIAS																
32	AMPBBIAS																

Pin No.	Symbol	I/O	Typical pin voltage	Equivalent circuit	Description		
33	GAMR_WHP	I	0 to 5V		Gamma white position control. Independent control for R, G and B. Equivalent to 2.5V input when open.		
34	GAMG_WHP						
35	GAMB_WHP						
36	GAMR_B1P				Gamma black 1 position control. Independent control for R, G and B. Equivalent to 2.5V input when open.		
37	GAMG_B1P				Gamma black 2 position control. Independent control for R, G and B. Equivalent to 2.5V input when open.		
38	GAMB_B1P				Gamma white gain control. Independent control for R, G and B. Equivalent to 2.5V input when open.		
39	GAMR_B2P				Gamma black 1 gain control. Independent control for R, G and B. Equivalent to 2.5V input when open.		
40	GAMG_B2P				Gamma black 2 gain control. Independent control for R, G and B. Equivalent to 2.5V input when open.		
41	GAMB_B2P						
42	GAMR_WHG						
43	GAMG_WHG						
44	GAMB_WHG						
45	GAMR_B1G						
46	GAMG_B1G						
47	GAMB_B1G						
48	GAMR_B2G						
49	GAMG_B2G						
50	GAMB_B2G						
51	SCL			I	L/H (0V/5V)		I ² C bus clock input.
52	SDA			I/O			I ² C bus data input.

I²C Bus Format

Slave address: 0111 0110 (76h)

Sub address	bit7	bit6	bit5	bit4	bit3	bit2	bit1	bit0
***00000 (00h)								
***00001 (01h)								
***00010 (02h)								
***00011 (03h)								
***00100 (04h)								
***00101 (05h)								
***00110 (06h)								
***00111 (07h)								
***01000 (08h)								
***01001 (09h)								
***01010 (0Ah)								
***01011 (0Bh)								
***01100 (0Ch)								
***01101 (0Dh)								
***01110 (0Eh)								
***01111 (0Fh)								
***10000 (10h)								
***10001 (11h)								
***10010 (12h)								
***10011 (13h)								
***10100 (14h)								
***10101 (15h)							GAMOFF	DATEST
***10110 (16h)							POS_CNT2	
***10111 (17h)							POS_CNT1	
***11000 (18h)							DIR_CNT	INV_CNT

Electrical Characteristics (See the Electrical Characteristics Measurement Circuit.) (V_{CC} , PV_{CC} = 5V, T_a = 25°C)

No.	Item	Symbol	Measurement point	Measurement conditions and measurement outline	Min.	Typ.	Max.	Unit
1	Current consumption	Icc	I21	[Gamma gain (white, black 1, black 2) = max., amplifier gain = max.] V22, 24, and 26 = 2.5V, V27 to 29 and 42 to 50 = 5V, V30 to 41 = open, Measure the I21 current.	80	135	180	mA
2	Digital input voltage high	Vih		Excluding the I ² C bus pins (Pins 51 and 52).	2.2		V _{CC}	V
3	Digital input voltage low	Vil		Excluding the I ² C bus pins (Pins 51 and 52).	GND		0.8	V
4	Maximum input voltage amplitude	Vix		Pins 22, 24 and 26 input	2			V
5	Maximum output voltage amplitude	Vox	V14 V16 V18	Pins 14, 16 and 18 output	1.5			V
6	Gamma white gain max.	Ggwx	V14 V16 V18	V27 to 29 and 36 to 44 = 5V, V30 to 35 = open, V45 to 50 = 0V Calculate V _{wx} /V _o (a) for the maximum V _{wx} at V _o (e), V _o (f) and V _o (g).	6.0	7.4	9.2	times
7	Gamma black 1 gain max.	Ggb1x	V14 V16 V18	V27 to 29, 39 to 41 and 45 to 47 = 5V, V30 to 32 and 36 to 38 = open, V33 to 35, 42 to 44 and 48 to 50 = 0V. Calculate V _{b1x} /V _o (i) for the maximum V _{b1x} at V _o (c), V _o (d) V _o (e) and V _o (f).	8.0	9.5	11.6	times
8	Gamma black 2 gain max.	Ggb2x	V14 V16 V18	V27 to 29, 36 to 38 and 48 to 50 = 5V, V30 to 32 = 3.75V, V33 to 35 and 42 to 47 = 0V, V39 to 41 = 3.3V Calculate V _{b2x} /V _o (h) for the maximum V _{b2x} at V _o (a), V _o (b) and V _o (c).	16.0	19.7	26.8	times
9	Amplifier gain max.	Gax	V14 V16 V18	V13 = 0V, V27 to 29 = 0V, V30 to 50 = open Calculate V _o (j)/0.1.	1.65	2.26	3.25	times
10	Amplifier gain min.	Gan	V14 V16 V18	V13 = 0V, V27 to 29 = 5V, V30 to 50 = open Calculate V _o (j)/0.1.	0.28	0.35	0.46	times
11	Amplifier bias output variable range	Vab	V14 V16 V18	V13 = 0V, V22, 24 and 26 = 2.5V, V27 to 29 = 0.75V, V33 to 50 = open V14, 16 and 18 voltages when V30 to 32 = 0V, open and 5V. Calculate V _b (0V) – V _b (open) and V _b (5V) – V _b (open) at V _b (0V), V _b (open) and V _b (5V).	±0.80	±0.96	±1.15	V
12	Gamma white gain I ² C max.	Ggwx _i	V14 V16 V18	V27 to 29 and 36 to 44 = 5V, V30 to 35 and 42 to 44 = open, V45 to 50 = 0V, I ² C data = 3Fh Calculate V _{wxi} /V _o (a) for the maximum V _{wxi} at V _o (e), V _o (f) and V _o (g).	5.85	7.21	8.65	times
13	Gamma white gain I ² C min.	Ggw _n _i	V14 V16 V18	V27 to 29 and 36 to 44 = 5V, V30 to 35 and 42 to 44 = open, V45 to 50 = 0V, I ² C data = 00h Calculate V _{wni} /V _o (a) for the maximum V _{wni} at V _o (e), V _o (f) and V _o (g).	3.80	4.71	5.65	times
14	Gamma black 1 gain I ² C max.	Ggb1 _x _i	V14 V16 V18	V27 to 29, 39 to 41 and 45 to 47 = 5V, V30 to 32, 36 to 38 and 45 to 47 = open, V33 to 35, 42 to 44 and 48 to 50 = 0V, I ² C data = 3Fh Calculate V _{b1xi} /V _o (i) for the maximum V _{b1xi} at V _o (c), V _o (d) V _o (e) and V _o (f).	7.6	9.11	10.7	times
15	Gamma black 1 gain I ² C min.	Ggb1 _n _i	V14 V16 V18	V27 to 29, 39 to 41 and 45 to 47 = 5V, V30 to 32, 36 to 38 and 45 to 47 = open, V33 to 35, 42 to 44 and 48 to 50 = 0V, I ² C data = 00h Calculate V _{b1ni} /V _o (i) for the maximum V _{b1ni} at V _o (c), V _o (d) V _o (e) and V _o (f).	5.05	6.02	7.00	times
16	Gamma black 2 gain I ² C max.	Ggb2 _x _i	V14 V16 V18	V27 to 29, 36 to 38 and 48 to 50 = 5V, V30 to 32 = 3.75V, V33 to 35 and 42 to 47 = 0V, V39 to 41 = 3.3V, V48 to 50 = open, I ² C data = 3Fh Calculate V _{b2xi} /V _o (h) for the maximum V _{b2xi} at V _o (a), V _o (b) and V _o (c).	15.8	19.5	23.2	times

No.	Item	Symbol	Measurement point	Measurement conditions and measurement outline	Min.	Typ.	Max.	Unit
17	Gamma black 2 gain I ² C min.	Ggb2ni	V14 V16 V18	V27 to 29, 36 to 38 and 48 to 50 = 5V, V30 to 32 = 3.75V, V33 to 35 and 42 to 47 = 0V, V39 to 41 = 3.3V, V48 to 50 = open, I ² C data = 3Fh Calculate Vb2xi/Vo (h) for the maximum Vb2xi at Vo (a), Vo (b) and Vo (c).	11.3	14.0	16.7	times
18	Amplifier gain I ² C max.	Gaxi	V14 V16 V18	V13 = 0V, V27 to 50 = open, I ² C data = 00h Calculate Vo (j)/0.1.	0.44	0.55	0.67	times
19	Amplifier gain I ² C min.	Gani	V14 V16 V18	V13 = 0V, V27 to 50 = open, I ² C data = 3Fh Calculate Vo (j)/0.1.	0.30	0.39	0.47	times
20	Amplifier bias I ² C output variable range	Vabi	V14 V16 V18	V13 = 0V, V22, 24 and 26 = 2.5V, V27 to 29 = 0.75V, V30 to 50 = open V14, 16 and 18 voltages when I ² C data = 00h, 20h and 3Fh. Calculate Vbi (00h) – Vbi (20h) and Vbi (3Fh) – Vbi (20h) at Vbi (00h), Vbi (20h) and Vbi (3Fh).	±0.34	±0.39	±0.45	V
21	Frequency response	Gf	V14 V16 V18	[Gamma OFF, amplifier gain min., ratio of 100MHz to 20MHz] V13 = 0V, V27 to 29 = 5V, V30 to 50 = open Calculate 20*LOG {Vo (k)/Vo (j)}.	-2.7			dB
22	Clamp voltage min.	Vcn	Vr Vg Vb	SW22, 24, 26 = b, SW25 = ON V20 = 5V, V25 = 0V	1.35	1.45	1.55	V
23	Clamp voltage max.	Vcx	Vr Vg Vb	SW22, 24, 26 = b, SW25 = ON V20 = 5V, V25 = 5V	2.75	2.85	2.95	V
24	Black limiter voltage	Vbl	V14 V16 V18	V12 = 1.3V, V13 = 0V, V22, 24, 26 = 2V, V27 to 29 = 0.75V, V30 to 32 = 0V, V33 to 50 = open	1.00	1.19	1.35	V
25	Output maximum voltage value (white limiter voltage)	Vwl	V14 V16 V18	V13, 27 to 29 = 0V, V22, 24, 26 = 3.1V, V30 to 32 = 5V, V33 to 50 = open	3.50	3.71	4.00	V
26	SIDOUT output min.	Vsn	V6	V9 = V11 = 0.5 V, V10 = 0V or 5V	1.75	1.98	2.15	V
27	SIDOUT output max.	Vsx	V6	V9 = V11 = 4.5 V, V10 = 0V or 5V	3.30	3.48	3.65	V
28	I ² C DAC (6-bit) DLE	Dle		DAC output when DAC data = 00h, 1Fh, 20h and 3Fh. Calculate {V (20h) – V (1Fh)} / [{V (3Fh) – V (00h)} / 63] – 1 at V (00h), V (1Fh), V (20h) and V (3Fh).	-0.9		0.6	LSB
29	Output rise/fall time <Reference data>	Trf	V14 V16 V18	Gamma OFF, gain adjusted so that 1Vp-p pulse input results in 1.5Vp-p output, output 3pF load		4		ns
30	Gamma position max. (white/black 1/black 2) <Reference data>	Pgx		With input DC 2.0 to 3.0V set as 0 to 100 IRE V33 to V41 = 0V	100			IRE
31	Gamma position min. (white/black 1/black 2) <Reference data>	Pgn		With input DC 2.0 to 3.0V set as 0 to 100 IRE V33 to V41 = 5V			0	IRE
32	Gamma position I ² C max. (white) <Reference data>	Pgwx		With input DC 2.0 to 3.0V set as 0 to 100 IRE V33 to 35 = open, I ² C data = 3Fh		100		IRE
33	Gamma position I ² C min. (white) <Reference data>	Pgwn		With input DC 2.0 to 3.0V set as 0 to 100 IRE V33 to 35 = open, I ² C data = 00h		40		IRE
34	Gamma position I ² C max. (black 1/black 2) <Reference data>	Pgbx		With input DC 2.0 to 3.0V set as 0 to 100 IRE V36 to 41 = open, I ² C data = 00h		70		IRE
35	Gamma position I ² C min. (black 1/black 2) <Reference data>	Pgbn		With input DC 2.0 to 3.0V set as 0 to 100 IRE V36 to 41 = open, I ² C data = 3Fh		0		IRE

Electrical Characteristics Measurement Circuit

<I²C standard data>

Slave address = 76h

No.	Item	Data
1	AMPARGAIN	00h
2	AMPGGAIN	00h
3	AMPBGAIN	00h
4	AMPBBIAS	20h
5	AMPGBIAS	20h
6	AMPBBIAS	20h
7	GAMR_WHP	00h
8	GAMG_WHP	00h
9	GAMB_WHP	00h
10	GAMR_B1P	00h
11	GAMG_B1P	00h
12	GAMB_B1P	00h
13	GAMR_B2P	00h
14	GAMG_B2P	00h
15	GAMB_B2P	00h
16	GAMR_WHG	00h
17	GAMG_WHG	00h
18	GAMB_WHG	00h
19	GAMR_B1G	00h
20	GAMG_B1G	00h
21	GAMB_B1G	00h
22	GAMR_B2G	00h
23	GAMG_B2G	00h
24	GAMB_B2G	00h
25	DLY_CNT	00h
26	POS_CNT1	00
27	POS_CNT2	00
28	DIR_CNT	0
29	INV_CNT	0
30	GAMOFF	0
31	DATEST	1

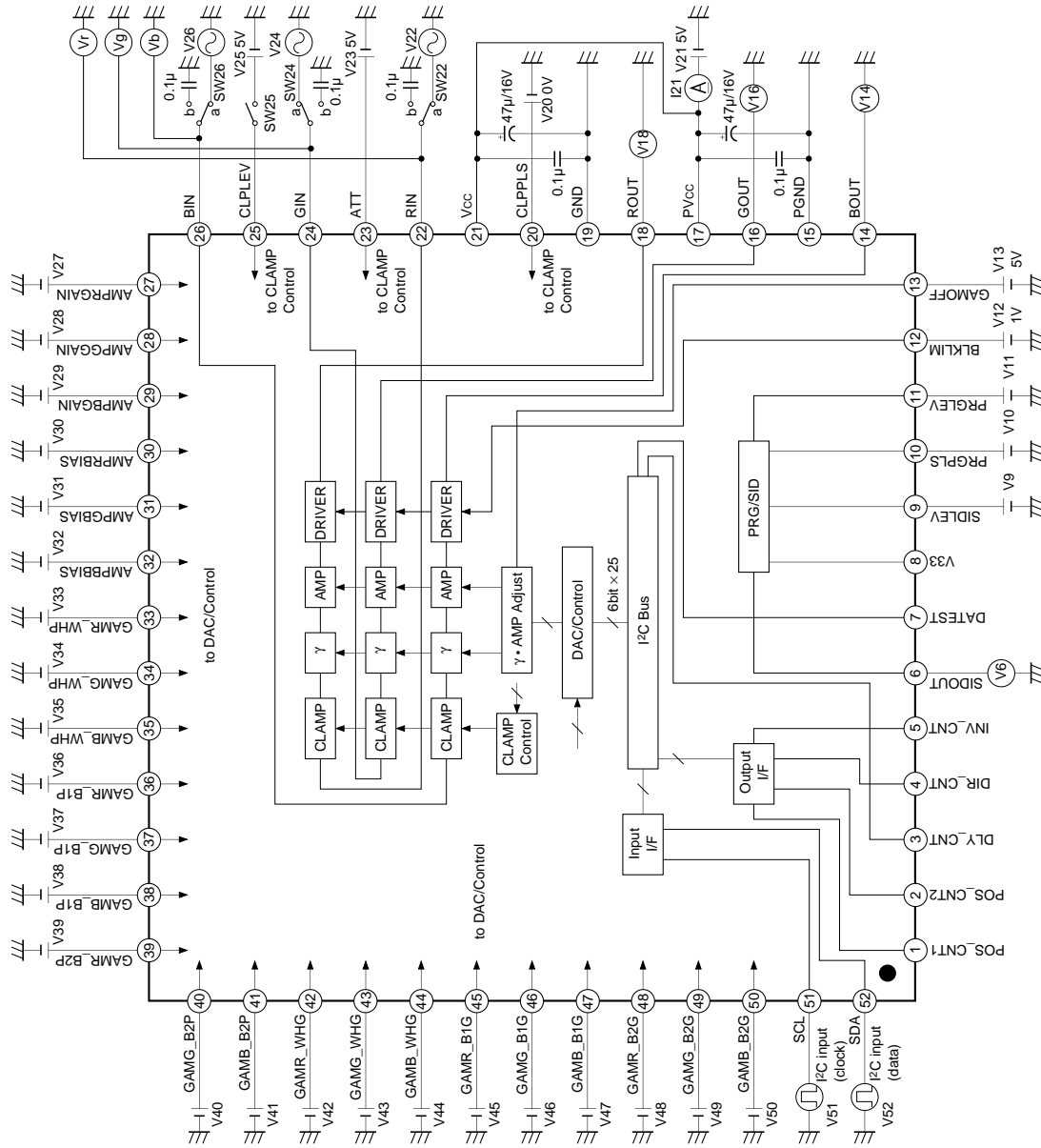

The following sine wave signals are defined as the V22, 24 and 26 inputs.

- (a) 2.15Vdc + 0.1Vp-p 20MHz
- (b) 2.25Vdc + 0.1Vp-p 20MHz
- (c) 2.35Vdc + 0.1Vp-p 20MHz
- (d) 2.45Vdc + 0.1Vp-p 20MHz
- (e) 2.55Vdc + 0.1Vp-p 20MHz
- (f) 2.65Vdc + 0.1Vp-p 20MHz
- (g) 2.75Vdc + 0.1Vp-p 20MHz
- (h) 2.85Vdc + 0.1Vp-p 20MHz
- (i) 2.95Vdc + 0.1Vp-p 20MHz
- (j) 2.5Vdc + 0.1Vp-p 20MHz
- (k) 2.5Vdc + 0.1Vp-p 100MHz

In addition, the V14, 16 and 18 output levels for the above inputs (x) are labeled Vo (x).

Description of Operation

1. Gamma control

The bend positions and respective gains of one white side point and two black side points can be varied.
 Control is performed independently for R, G and B by the I²C bus or by external DC.
 In addition, the gamma function can easily be forced OFF (by Pin 13 or the I²C bus).

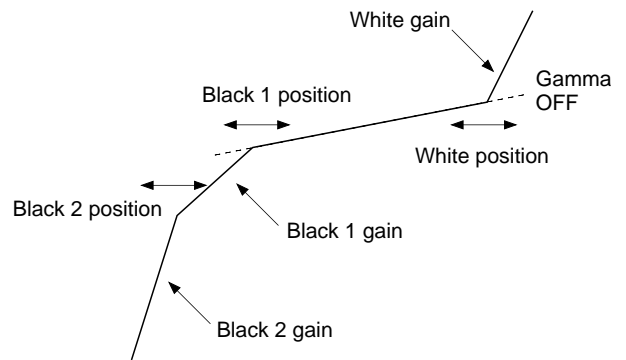

2. Amplifier gain and bias control

After adjusting the gamma, the signal gain and DC voltage can also be adjusted.

3. SIDOUT

SIDOUT generates the precharge signal.
 After the CXA2111R determines the DC level (Pins 9 and 11) and the pulse width (Pin 10), the signal is inverted by the CXA2112R and applied to the LCD panel.
 See the Example of Representative Characteristics for the DC level.

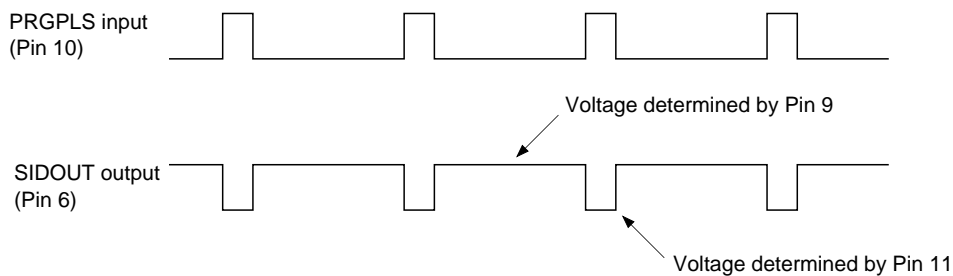

Output example

4. I²C bus

The various gamma and amplifier controls can be performed in accordance with the I²C Bus Format table.
 In addition, the sample-and-hold position and other items can also be controlled by connecting the CXA2112R.

Notes on Operation

1. External DC voltage adjustment, I²C adjustment and variable ranges

(a) When varying the external DC voltage

Setting the I²C data to the standard setting values (listed in the Electrical Characteristics Measurement Circuit) is recommended when performing the various adjustments using the external pins (Pins 27 to 50). Note that setting data that differs from these standard setting values may clip one side of the variable ranges below.

(b) When varying the I²C setting

The variable ranges when the external pins are open or 2.5V are as shown in the table below. The I²C variable range position can be altered by changing the voltage applied to the external pins. However, note that characteristics in excess of the range in (a) above cannot be obtained.

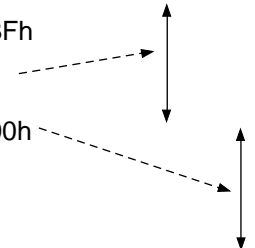
	(a) External voltage adjustment	(b) I ² C adjustment (external pins open or 2.5V)
γ white gain	$\times 7.4$ \uparrow 5V \downarrow 0V $\times 1$ (I ² C standard setting 00h)	$\times 7.21$ \uparrow 3Fh \downarrow 00h $\times 4.71$  The variable position can be altered by changing the external voltage.
γ black 1 gain	$\times 9.5$ \uparrow 5V \downarrow 0V $\times 1$ (I ² C standard setting 00h)	$\times 9.11$ \uparrow 3Fh \downarrow 00h $\times 6.02$
γ black 2 gain	$\times 19.7$ \uparrow 5V \downarrow 0V $\times 1$ (I ² C standard setting 00h)	$\times 19.5$ \uparrow 3Fh \downarrow 00h $\times 14.0$

	(a) External voltage adjustment	(b) I ² C adjustment (external pins open or 2.5V)
γ white position	<p>100 IRE ↑ 0V</p> <p>↓ 5V</p> <p>0 IRE</p> <p>(I²C standard setting 00h)</p>	<p>100 IRE ↑ 3Fh</p> <p>↓ 00h</p> <p>40 IRE</p>
γ black 1 position	<p>100 IRE ↑ 0V</p> <p>↓ 5V</p> <p>0 IRE</p> <p>(I²C standard setting 00h)</p>	<p>70 IRE ↑ 00h</p> <p>↓ 3Fh</p> <p>0 IRE</p>
γ black 2 position	<p>100 IRE ↑ 0V</p> <p>↓ 5V</p> <p>0 IRE</p> <p>(I²C standard setting 00h)</p>	<p>70 IRE ↑ 00h</p> <p>↓ 3Fh</p> <p>0 IRE</p>

Note) The 0 to 100 IRE levels here correspond to the following values when ATT (Pin 23) is high.

Clamp OFF: Input 2 to 3V (1Vp-p)

Clamp ON: Input 1Vp-p (however, Pin 25 = open or 2.5V)

	(a) External voltage adjustment	(b) I ² C adjustment (external pins open or 2.5V)
Amplifier gain	$\times 2.26$ ↑ 0V ↓ 5V $\times 0.35$ (I ² C standard setting 00h)	$\times 0.55$ ↑ 00h ↓ 3Fh $\times 0.39$
Amplifier bias (relative variation)	+0.96V ↑ 5V 0V — 2.5V ↓ 0V -0.96V (I ² C standard setting 20h)	+0.39V ↑ 00h 0V — 20h ↓ 3Fh -0.39V

2. Input signal level and clamp

Set Pin 23 (ATT) low when the input amplitude exceeds 1Vp-p (up to 2Vp-p).

In this case, care should be taken for the clamp voltage setting (Pin 25) when applying the clamp. See the figure below.

(The input pin voltage should not exceed the range of 1.5V DC to 3.5V DC.)

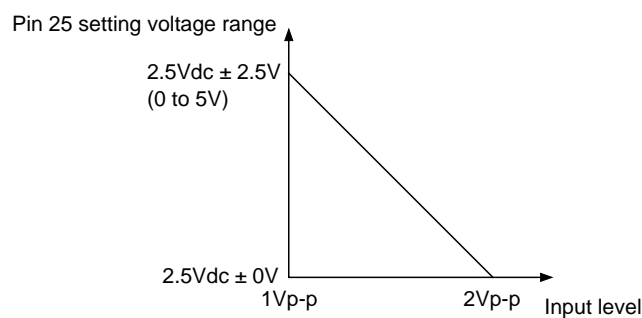

3. I²C bus

The CXA2111R requires I²C bus control.

The initial values must be set after power-on even when using only external DC adjustment.

Application Circuit

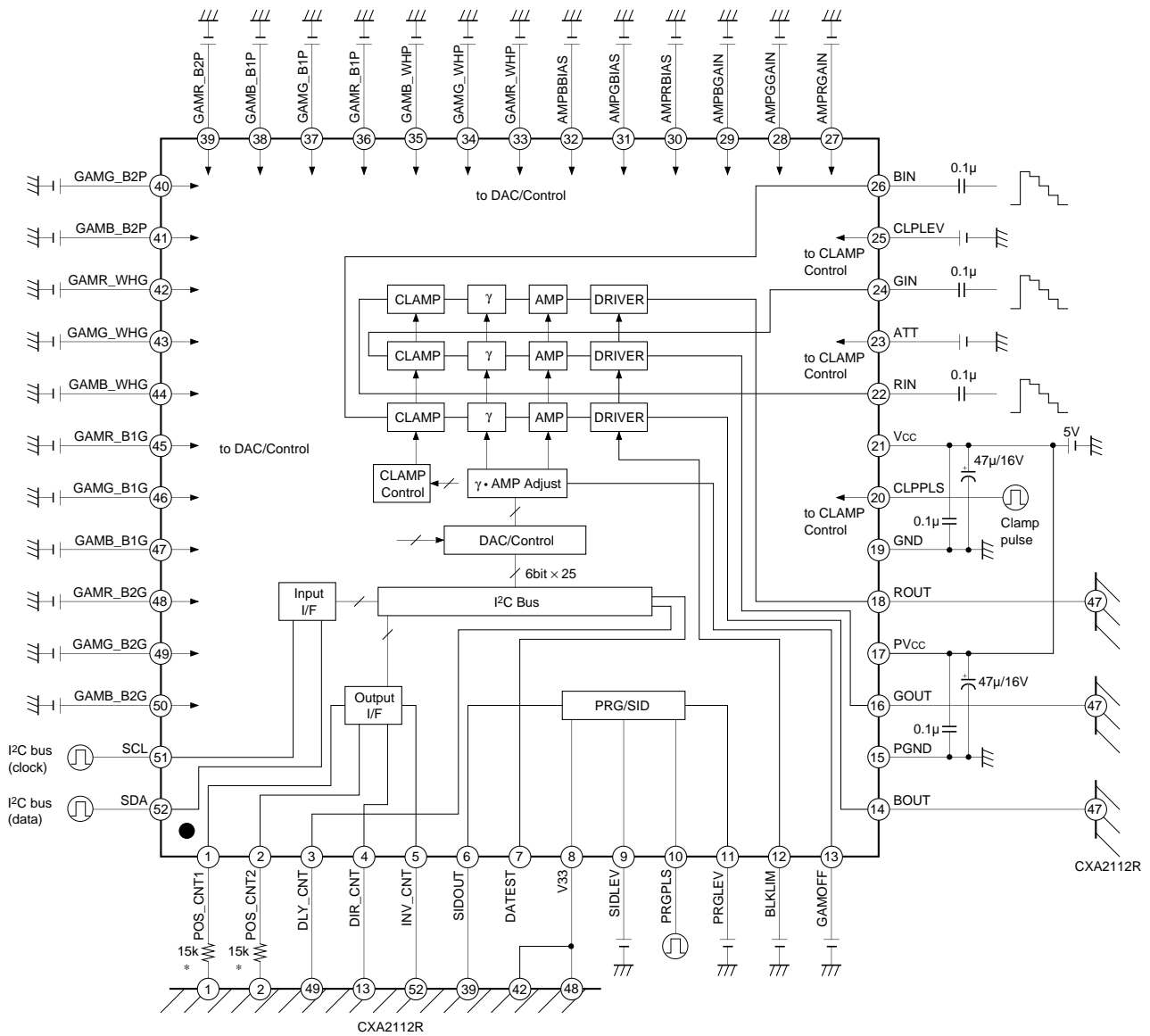

* When using two CXA2112R, connect the ICs directly without inserting resistors.

Application circuits shown are typical examples illustrating the operation of the devices. Sony cannot assume responsibility for any problems arising out of the use of these circuits or for any infringement of third party patent and other right due to same.

Example of Representative Characteristics ($V_{CC} = 5V$, $T_a = 25^\circ C$)

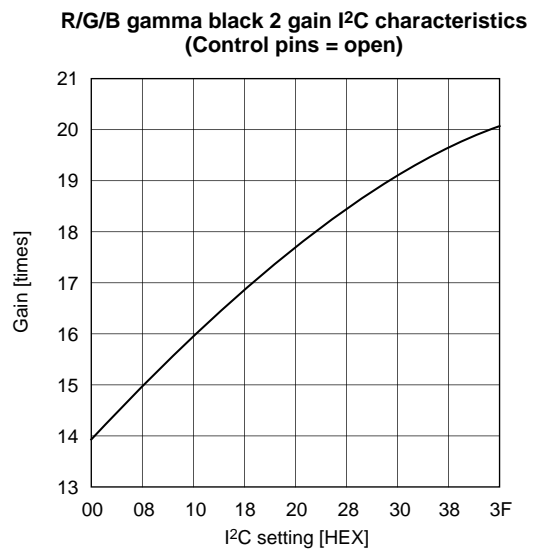
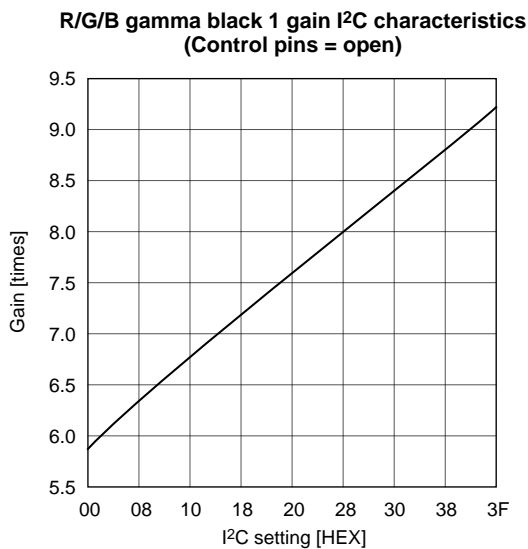
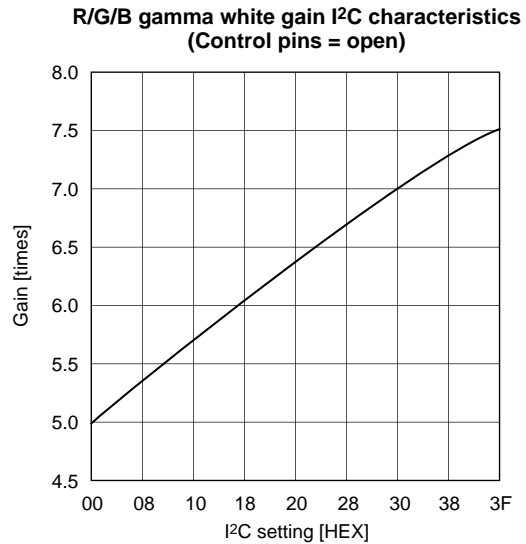
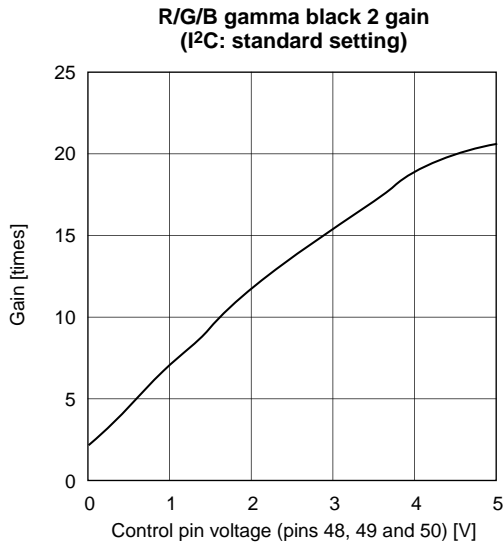
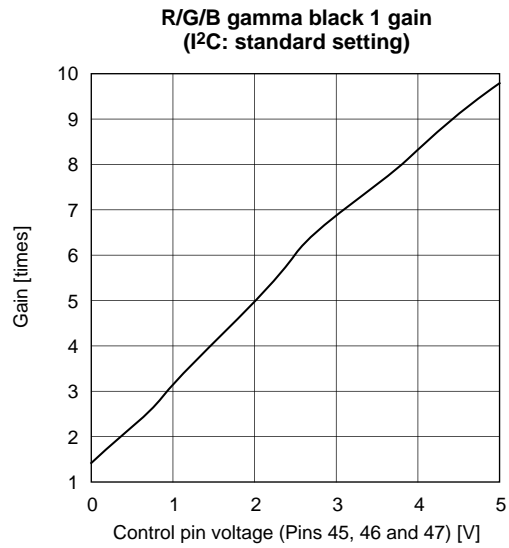
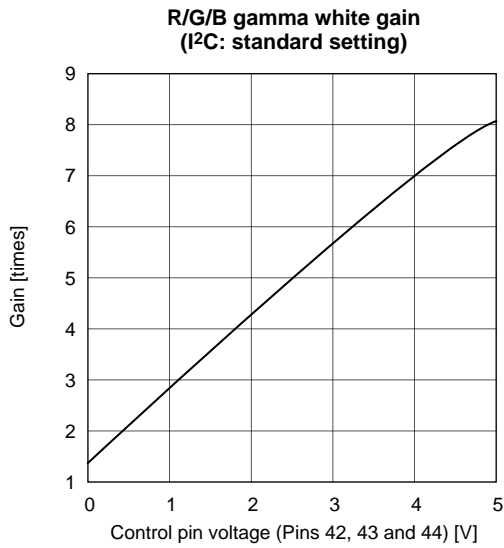

**R/G/B amplifier gain
(I²C: Standard setting)**

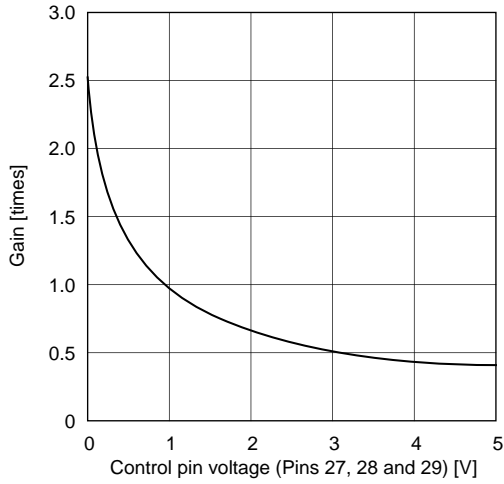

**R/G/B amplifier gain I²C characteristics
(Control pins = open)**

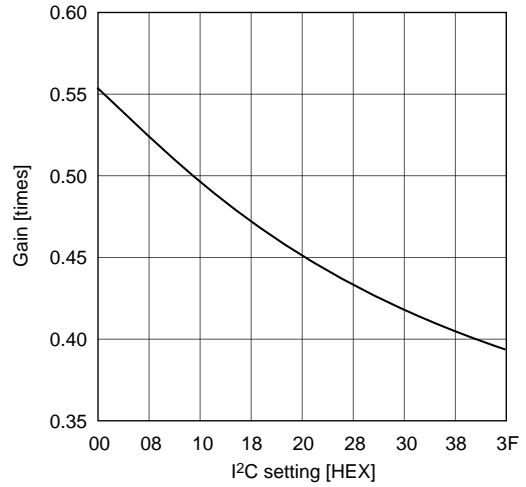

R/G/B output black limiter voltage

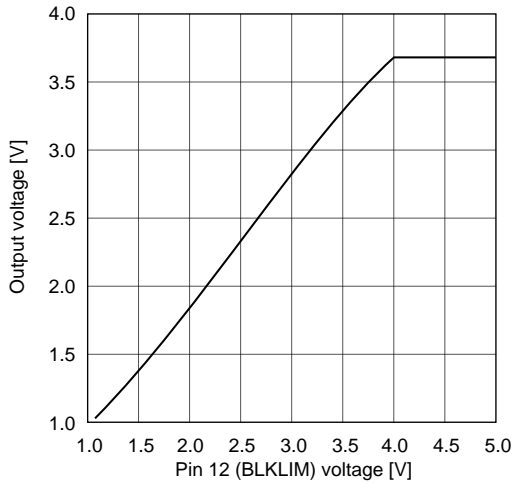

R/G/B input clamp voltage characteristics

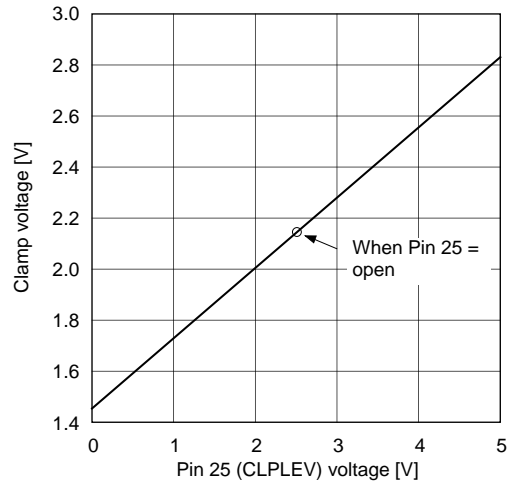

Pin 6 (SIDOUT) output

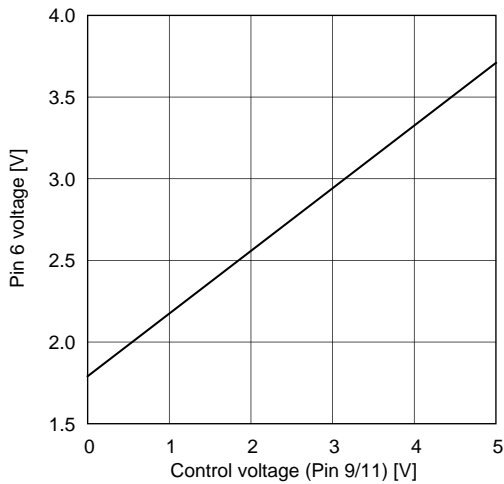

**R/G/B frequency response
(Gamma OFF, amplifier gain = min.)**

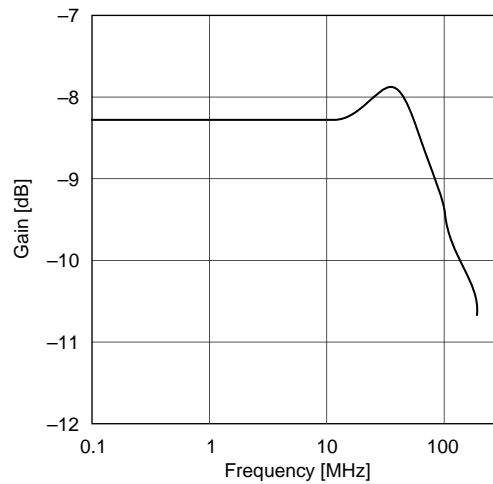

Package Outline

Unit: mm

52PIN LQFP(PLASTIC)

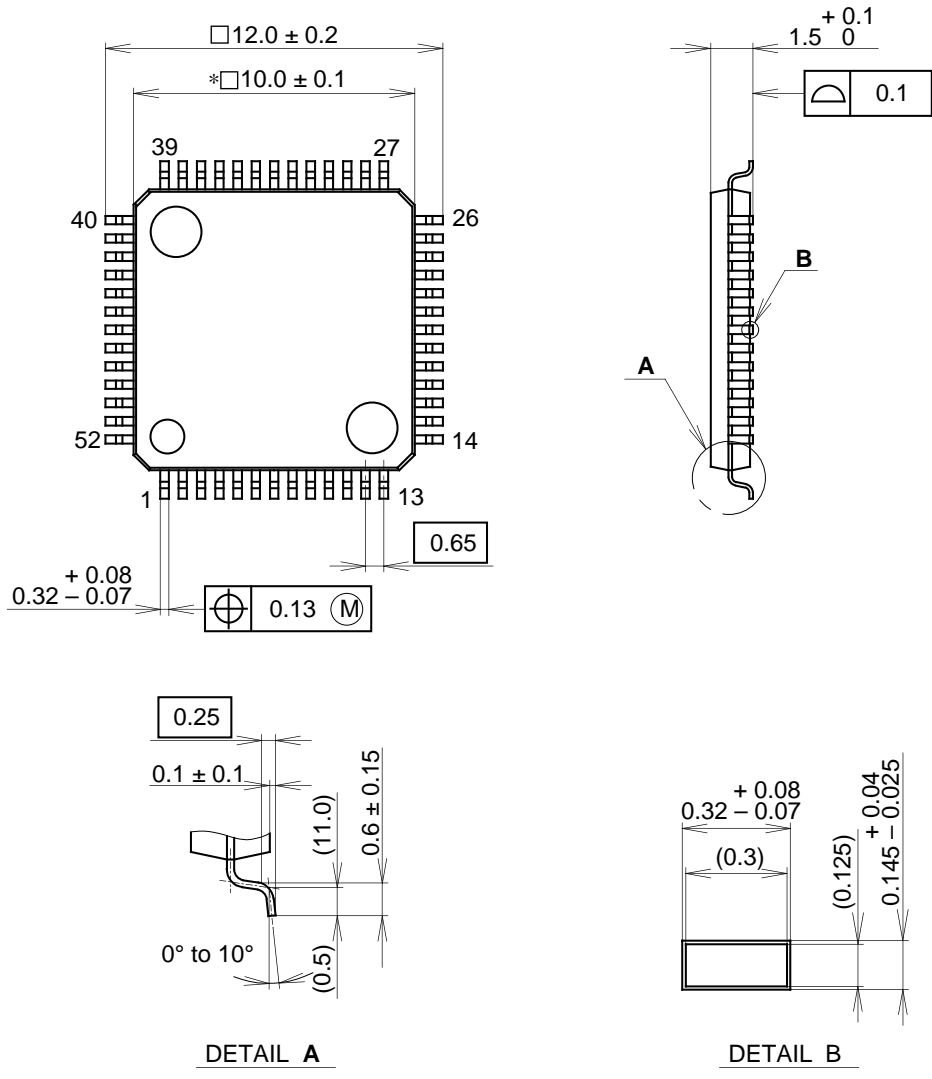

NOTE: Dimension "*" does not include mold protrusion.

PACKAGE STRUCTURE

SONY CODE	LQFP-52P-L01
EIAJ CODE	LQFP052-P-1010
JEDEC CODE	_____

PACKAGE MATERIAL	EPOXY RESIN
LEAD TREATMENT	PALLADIUM PLATING
LEAD MATERIAL	COPPER ALLOY
PACKAGE MASS	0.3g