

# Field and Factory Programmable Spread Spectrum Clock Generator for EMI Reduction

## Features

- Wide Operating Output (SSCLK) Frequency Range
  - 3 MHz to 200 MHz
- Programmable Spread Spectrum with nominal 31.5 kHz Modulation Frequency
  - Center Spread:  $\pm 0.25\%$  to  $\pm 2.5\%$
  - Down Spread:  $-0.5\%$  to  $-5.0\%$
- Input frequency range
  - External Crystal: 8 to 30 MHz Fundamental Crystals
  - External Reference: 8 to 166 MHz Clock
- Integrated Phase-Locked Loop (PLL)
- Field Programmable devices available
- Programmable Crystal Load Capacitor Tuning Array
- Low Cycle-to-cycle Jitter
- Spread Spectrum on/off function
- Powerdown or Output Enable function
- Commercial and Industrial temperature ranges
- 3.3 V operation
- 8-pin TSSOP and SOIC packages

## Functional Description

The CY25100 is a Spread Spectrum Clock Generator (SSCG) IC used to reduce EMI found in today's high speed digital electronic systems.

The device uses a Cypress proprietary PLL and Spread Spectrum Clock (SSC) technology to synthesize and modulate the frequency of the input clock. By frequency modulating the clock, the measured EMI at the fundamental and harmonic frequencies are greatly reduced. This reduction in radiated energy can significantly reduce the cost of complying with regulatory agency (EMC) requirements and improve time-to-market without degrading system performance.

The CY25100 uses a factory or field-programmable configuration memory array to synthesize output frequency, spread percentage, crystal load capacitor, reference clock output on/off, spread spectrum on/off function, and PD#/OE options.

The spread percentage is programmed to either center spread or down spread with various spread percentages. The range for center spread is from  $\pm 0.25\%$  to  $\pm 2.50\%$ . The range for down spread is from  $-0.5\%$  to  $-5.0\%$ .

The input to the CY25100 can either be a crystal or a clock signal. The CY25100 has two clock outputs: REFCLK and SSCLK. The non-spread spectrum REFCLK output has the same frequency as the input of the CY25100.

## Logic Block Diagram

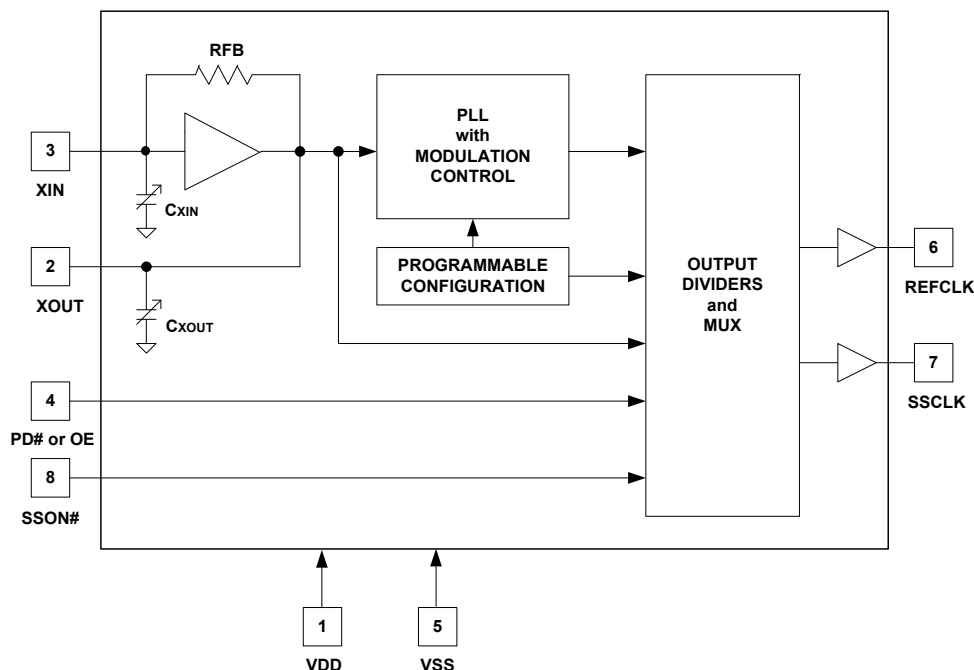

**Contents**

<b>Pinouts</b> .....	<b>3</b>	<b>Operating Conditions</b> .....	<b>5</b>
<b>Pin Description</b> .....	<b>3</b>	<b>DC Electrical Characteristics</b> .....	<b>6</b>
<b>Programming Description</b> .....	<b>4</b>	<b>AC Electrical Characteristics</b> .....	<b>7</b>
<b>Field Programmable CY25100</b> .....	<b>4</b>	<b>Application Circuit</b> .....	<b>8</b>
CyberClocks™ Online Software .....	4	<b>Switching Waveforms</b> .....	<b>9</b>
CY3672 Programmer and		<b>Informational Graphs</b> .....	<b>10</b>
CY3690/CY3691 Socket Adapters .....	4	<b>Ordering Information</b> .....	<b>12</b>
Factory Programmable CY25100 .....	4	Possible Configurations .....	12
<b>Product Functions</b> .....	<b>4</b>	Ordering Code Definitions .....	13
Input Frequency (XIN, Pin 3 and XOUT, Pin 2) .....	4	<b>Package Diagrams</b> .....	<b>13</b>
CXIN and CXOUT (Pin 3 and Pin 2) .....	4	<b>Acronyms</b> .....	<b>15</b>
Output Frequency (SSCLK, Pin 7) .....	4	<b>Document Conventions</b> .....	<b>15</b>
Spread Percentage (SSCLK, Pin 7) .....	4	Units of Measure .....	15
Reference Output (REFOUT, Pin 6) .....	4	<b>Document History Page</b> .....	<b>16</b>
Modulation Frequency .....	4	<b>Sales, Solutions, and Legal Information</b> .....	<b>17</b>
Power Down or Output Enable (PD# or OE, Pin 4) .....	4	Worldwide Sales and Design Support .....	17
<b>Absolute Maximum Rating</b> .....	<b>5</b>	Products .....	17
<b>Recommended Crystal Specifications</b> .....	<b>5</b>	PSoC Solutions .....	17

Pinouts

Figure 1. CY25100 8-pin SOIC/TSSOP

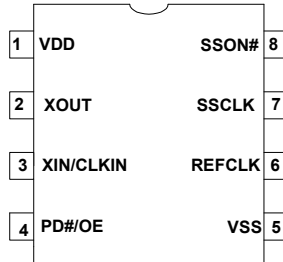

Pin Description

Pin	Name	Type	Description
1	VDD	Power	3.3 V power supply.
2	XOUT	Output	Crystal output. Leave this pin floating if external clock is connected to pin 3.
3	XIN/CLKIN	Input	Crystal input or reference clock input.
4	PD#/OE	Input	User has the option of choosing either PD# or OE function. Power Down pin: Active LOW. If PD# = 0, PLL and crystal oscillator circuit are powered down, and outputs are weakly pulled low. Output Enable pin: Active HIGH. If OE = 1, SSCLK and REFCLK are enabled.
5	VSS	Power	Power supply ground.
6	REFCLK	Output	Buffered reference output.
7	SSCLK	Output	Spread spectrum clock output.
8	SSON#	Input	Spread spectrum control: Active LOW. 0 = spread on. 1 = spread off.

Table 1. User Specified Variables

Pin Function	Input Frequency	Total Crystal Load Capacitance	Output Frequency	Spread Percent (0.5% – 5%, 0.25% granularity)	Reference Output	Power Down or Output Enable
Pin Name	XIN and XOUT	XIN and XOUT	SSCLK	SSCLK	REFOUT	PD#/OE
Pin#	3 and 2	3 and 2	7	7	6	4
Unit	MHz	pF	MHz	% and Center- or Down-spread	On or Off	Select PD# or OE
	USER SPECIFIED	USER SPECIFIED	USER SPECIFIED	USER SPECIFIED	USER SPECIFIED	USER SPECIFIED

## Programming Description

### Field Programmable CY25100

The CY25100 is programmed at the package level, and must be programmed prior to installation on a circuit board. Field programmable devices are denoted by an “F” in the ordering code, and are blank when shipped. The CY25100 is Flash technology based, which allows it to be reprogrammed up to 100 times. This allows fast and easy design changes and product updates, and eliminates issues with old and out of date inventory.

Samples and small prototype quantities can be programmed on the CY3672 programmer with the CY3690 (TSSOP package) or CY3691 (SOIC package) socket adapter.

### CyberClocks™ Online Software

CyberClocks™ Online Software is a web based software application that allows the user to custom-configure the CY25100. All of the parameters in [Table 1 on page 3](#) can be entered as variables into the software. CyberClocks Online outputs an industry-standard JEDEC file which is used for programming the CY25100. CyberClocks Online is available at [www.cyberclocksonline.com](http://www.cyberclocksonline.com) web site.

### CY3672 Programmer and CY3690/CY3691 Socket Adapters

The Cypress CY3672 programmer and the CY3690 or CY3691 socket adapter may be used to program field programmable versions of the CY25100. The CY3690 enables users to program the CY25100ZXC and CY25100ZXIF (TSSOP). CY3691 provides the ability to program the CY25100SXC and CY25100SXIF (SOIC). The CY3690 and CY3691 are separate orderable items, so the existing users of the CY3672 programmer need to order only the specific socket adapter to program the CY25100.

### Factory Programmable CY25100

Factory programming by Cypress is available for high volume orders. All requests must be submitted to the local Cypress Field Application Engineer (FAE) or sales representative. After the request is processed, you will receive a new part number, samples, and data sheet with the programmed values. This part number is used for additional sample requests and production orders.

## Product Functions

### Input Frequency (XIN, Pin 3 and XOUT, Pin 2)

The input to the CY25100 can be a crystal or a clock. The input frequency range for crystals is 8 to 30 MHz, and for clock signals is 8 to 166 MHz.

### C<sub>XIN</sub> and C<sub>XOUT</sub> (Pin 3 and Pin 2)

The CY25100 has internal load capacitors at Pin 3 (C<sub>XIN</sub>) and Pin 2 (C<sub>XOUT</sub>). C<sub>XIN</sub> always equals C<sub>XOUT</sub>, and they are programmable from 12 pF to 60 pF, in 0.5 pF increments. This feature eliminates the need for external crystal load capacitors.

The following formula is used to calculate the value of C<sub>XIN</sub> and C<sub>XOUT</sub> for matching the crystal load (C<sub>L</sub>):

$$C_{XIN} = C_{XOUT} = 2C_L - C_P$$

where C<sub>L</sub> is the crystal load capacitor as specified by the crystal manufacturer and C<sub>P</sub> is the parasitic PCB capacitance on each node of the crystal.

For example, if a crystal with C<sub>L</sub> of 16 pF is used, and C<sub>P</sub> is 2 pF, C<sub>XIN</sub> and C<sub>XOUT</sub> are calculated as:

$$C_{XIN} = C_{XOUT} = (2 \times 16) - 2 = 30 \text{ pF}$$

If using a driven reference, set C<sub>XIN</sub> and C<sub>XOUT</sub> to the minimum value 12 pF, connect the reference to XIN/CLKIN, and leave XOUT unconnected.

### Output Frequency (SSCLK, Pin 7)

The modulated frequency at the SSCLK output is produced by synthesizing the input reference clock. The modulation can be stopped by SSON# digital control input (SSON# = HIGH, no modulation). If modulation is stopped, the clock frequency is the nominal value of the synthesized frequency without modulation (spread percentage = 0). The range of synthesized clock is from 3 to 200 MHz.

### Spread Percentage (SSCLK, Pin 7)

The SSCLK spread can be programmed at any percentage value from ±0.25% to ±2.5% for center spread and from -0.5% to -5.0% for down spread.

### Reference Output (REFOUT, Pin 6)

The reference clock output has the same frequency and the same phase as the input clock. This output can be programmed to be enabled (clock on) or disabled (High Z, clock off). If this output is not required, it is recommended that the disabled (High Z, Clock Off) option be selected.

### Modulation Frequency

The modulation frequency is 31.5 kHz for all SSCLK frequencies from 3 to 200 MHz.

### Power Down or Output Enable (PD# or OE, Pin 4)

The part can be programmed to include either PD# or OE function. PD# function powers down the oscillator and PLL. The OE function disables the outputs.

**Absolute Maximum Rating**

Supply Voltage ( $V_{DD}$ )	-0.5 to +7.0 V	Junction Temperature	-40 °C to +125 °C
DC Input Voltage	-0.5 V to $V_{DD} + 0.5$ V	Data Retention at $T_j = 125$ °C	> 10 years
Storage Temperature (Non condensing)	-55 °C to +125 °C	Package Power Dissipation	350 mW
		Static Discharge Voltage (per MIL-STD-883, Method 3015)	$\geq 2000$ V

**Recommended Crystal Specifications**

Parameter	Description	Comments	Min	Typ	Max	Unit
$f_{NOM}$	Nominal Crystal Frequency	Parallel resonance, fundamental mode, AT cut	8	-	30	MHz
$C_{LNOM}$	Nominal Load Capacitance	Internal load caps	6	-	30	pF
$R_1$	Equivalent Series Resistance (ESR)	Fundamental mode	-	-	25	$\Omega$
$R_3/R_1$	Ratio of Third Overtone Mode ESR to Fundamental Mode ESR	Ratio used because typical $R_1$ values are much less than the maximum spec	3	-	-	-
DL	Crystal Drive Level	No external series resistor assumed	-	0.5	2	mW

**Operating Conditions**

Parameter	Description	Min	Typ	Max	Unit
$V_{DD}$	Supply Voltage	3.13	3.30	3.45	V
$T_A$	Ambient Commercial Temperature	0	-	70	°C
	Ambient Industrial Temperature	-40	-	85	°C
$C_{LOAD}$	Maximum Load Capacitance at Pin 6 and Pin 7	-	-	15	pF
$f_{REF}$	External Reference Crystal (Fundamental tuned crystals only)	8	-	30	MHz
	External Reference Clock	8	-	166	MHz
$f_{SSCLK}$	SSCLK Output Frequency, $C_{LOAD} = 15$ pF	3	-	200	MHz
$f_{REFCLK}$	REFCLK Output Frequency, $C_{LOAD} = 15$ pF	8	-	166	MHz
$f_{MOD}$	Spread Spectrum Modulation Frequency	30.0	31.5	33.0	kHz
$t_{PU}$	Power Up Time for all $V_{DD}$ 's to reach minimum specified voltage (power ramp must be monotonic)	0.05	-	500	ms

**DC Electrical Characteristics**

Parameter	Description	Condition	Min	Typ	Max	Unit
$I_{OH}$	Output High Current	$V_{OH} = V_{DD} - 0.5 \text{ V}$ , $V_{DD} = 3.3 \text{ V}$ (source)	10	12		mA
$I_{OL}$	Output Low Current	$V_{OL} = 0.5 \text{ V}$ , $V_{DD} = 3.3 \text{ V}$ (sink)	10	12		mA
$V_{IH}$	Input High Voltage	CMOS levels, 70% of $V_{DD}$	$0.7 \times V_{DD}$	–	$V_{DD}$	V
$V_{IL}$	Input Low Voltage	CMOS levels, 30% of $V_{DD}$	–	–	$0.3 \times V_{DD}$	V
$I_{IH}$	Input High Current, PD#/OE and SSON# Pins	$V_{in} = V_{DD}$	–10	–	10	$\mu\text{A}$
$I_{IL}$	Input Low Current, PD#/OE and SSON# Pins	$V_{in} = V_{SS}$	–10	–	10	$\mu\text{A}$
$I_{OZ}$	Output Leakage Current	Three-state output, PD#/OE = 0, output pulldown resistor disabled	–10		10	$\mu\text{A}$
$C_{XIN}$ or $C_{XOUT}$ <sup>[1]</sup>	Programmable Capacitance at Pin 2 and Pin 3	Capacitance at minimum setting	–	12	–	pF
		Capacitance at maximum setting	–	60	–	pF
$C_{IN}$ <sup>[1]</sup>	Input Capacitance at Pin 4 and Pin 8	Input pins excluding XIN and XOUT	–	5	7	pF
$I_{VDD}$	Supply Current	$V_{DD} = 3.45 \text{ V}$ , $F_{in} = 30 \text{ MHz}$ , REFCLK = 30 MHz, SSCLK = 66 MHz, $C_{LOAD} = 15 \text{ pF}$ , PD#/OE = SSON# = $V_{DD}$	–	25	35	mA
$I_{DDS}$	Standby Current	$V_{DD} = 3.45 \text{ V}$ , Device powered down with PD# = 0 V (driven reference pulled down)	–	15	30	$\mu\text{A}$

**Note**

1. Guaranteed by characterization, not 100% tested.

## AC Electrical Characteristics

The AC Electrical Characteristics for part CY25100 is as follows. [2]

Parameter	Description	Condition	Min	Typ	Max	Unit
DC	Output Duty Cycle	SSCLK, Measured at $V_{DD}/2$	45	50	55	%
	Output Duty Cycle	REFCLK, Measured at $V_{DD}/2$ , Duty Cycle of CLKIN = 50% at input bias	40	50	60	%
SR1	Rising Edge Slew Rate	SSCLK from 3 to 100 MHz; REFCLK from 3 to 100 MHz; 20%–80% of $V_{DD}$	0.7	1.1	3.6	V/ns
SR2	Falling Edge Slew Rate	SSCLK from 3 to 100 MHz; REFCLK from 3 to 100 MHz; 80%–20% of $V_{DD}$	0.7	1.1	3.6	V/ns
SR3	Rising Edge Slew Rate	SSCLK from 100 to 200 MHz; REFCLK from 100 to 166 MHz; 20%–80% of $V_{DD}$	1.0	1.6	4.0	V/ns
SR4	Falling Edge Slew Rate	SSCLK from 100 to 200 MHz; REFCLK from 100 to 166 MHz; 80%–20% of $V_{DD}$	1.2	1.6	4.0	V/ns
$t_{CCJ1}^{[3]}$	Cycle-to-Cycle Jitter, SSCLK (Pin 7)	CLKIN = SSCLK = 166 MHz, 2% spread, REFCLK off	–	90	120	ps
		CLKIN = SSCLK = 66 MHz, 2% spread, REFCLK off	–	100	130	ps
		CLKIN = SSCLK = 33 MHz, 2% spread, REFCLK off	–	130	170	ps
$t_{CCJ2}^{[3]}$	Cycle-to-Cycle Jitter, SSCLK (Pin 7)	CLKIN = SSCLK = 166 MHz, 2% spread, REFCLK on	–	100	130	ps
		CLKIN = SSCLK = 66 MHz, 2% spread, REFCLK on	–	105	140	ps
		CLKIN = SSCLK = 33 MHz, 2% spread, REFCLK on	–	200	260	ps
$t_{CCJ3}^{[3]}$	Cycle-to-Cycle Jitter, REFCLK (Pin 6)	CLKIN = SSCLK = 166 MHz, 2% spread, REFCLK on	–	80	100	ps
		CLKIN = SSCLK = 66 MHz, 2% spread, REFCLK on	–	100	130	ps
		CLKIN = SSCLK = 33 MHz, 2% spread, REFCLK on	–	135	180	ps
$t_{STP}$	Power down Time (pin 4 = PD#)	Time from falling edge on PD# to stopped outputs (Asynchronous)	–	150	350	ns
$t_{OE1}$	Output Disable Time (pin 4 = OE)	Time from falling edge on OE to stopped outputs (Asynchronous)	–	150	350	ns
$t_{OE2}$	Output Enable Time (pin 4 = OE)	Time from rising edge on OE to outputs at a valid frequency (Asynchronous)	–	150	350	ns
$t_{PU1}$	Power Up Time, Crystal is used	Time from rising edge on PD# to outputs at valid frequency (Asynchronous)	–	3.5	5	ms
$t_{PU2}$	Power Up Time, Reference clock is used	Time from rising edge on PD# to outputs at valid frequency (Asynchronous), reference clock at correct frequency	–	2	3	ms

### Notes

- Guaranteed by characterization, not 100% tested.
- Jitter is configuration dependent. Actual jitter is dependent on XIN jitter and edge rate, number of active outputs, output frequencies, spread percentage, temperature, and output load.

## Application Circuit

Figure 2. Application Circuit Diagram [4, 5, 6]

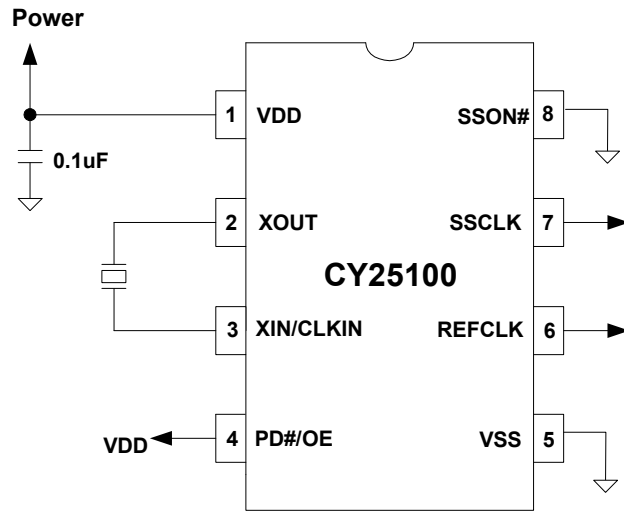

### Notes

4. Because the load capacitors ( $C_{XIN}$  and  $C_{XOUT}$ ) are provided by the CY25100, no external capacitors are needed on the  $X_{IN}$  and  $X_{OUT}$  pins to match the crystal load capacitor ( $C_L$ ). Only a single 0.1-µF bypass capacitor is required on the  $V_{DD}$  pin.
5. If an external clock is used, apply the clock to  $X_{IN}$  (pin 3) and leave  $X_{OUT}$  (pin 2) floating (unconnected).
6. If  $SSON\#$  (pin 8) is LOW ( $V_{SS}$ ), the frequency modulation is on at  $SSCLK$  (pin 7).



## Switching Waveforms

Figure 3. Duty Cycle Timing ( $DC = t_{1A}/t_{1B}$ )

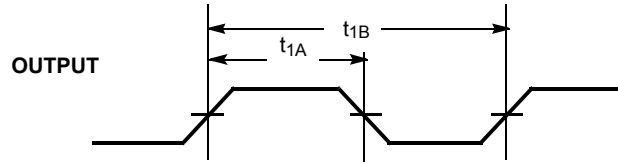
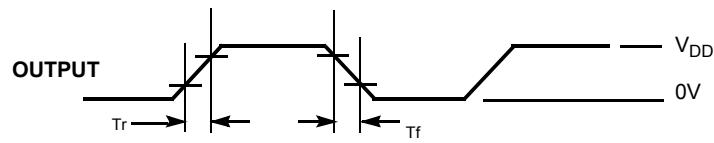

Figure 4. Output Rise/Fall Time (SSCLK and REFCLK)



Output Rise time ( $T_r$ ) =  $(0.6 \times V_{DD})/SR1$  (or  $SR3$ )  
 Output Fall time ( $T_f$ ) =  $(0.6 \times V_{DD})/SR2$  (or  $SR4$ )

Refer to AC Electrical Characteristics table for SR (Slew Rate) values.

Figure 5. Power Down and Power Up Timing

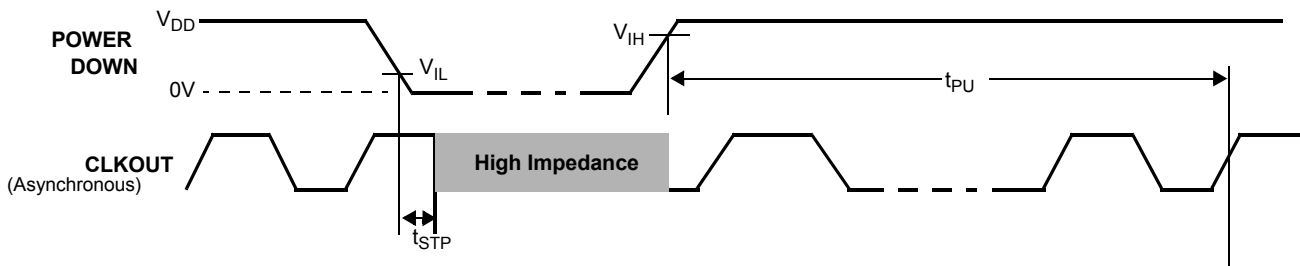
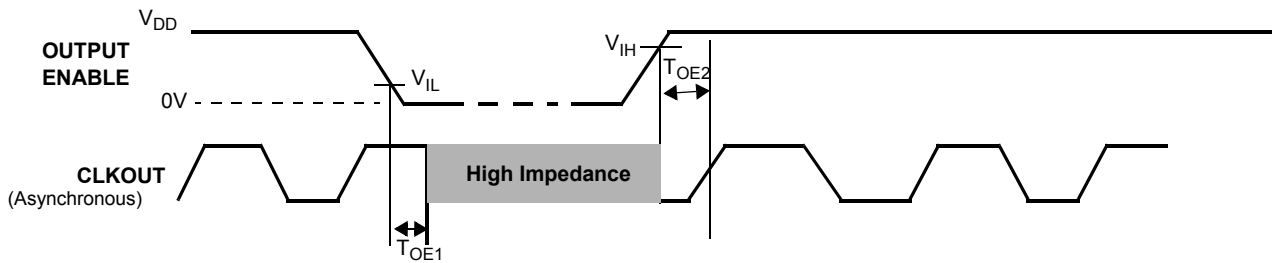
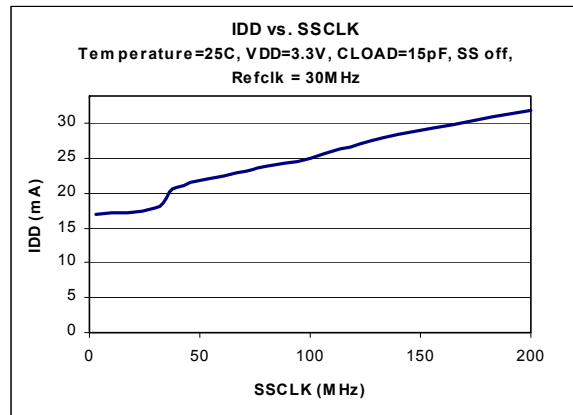
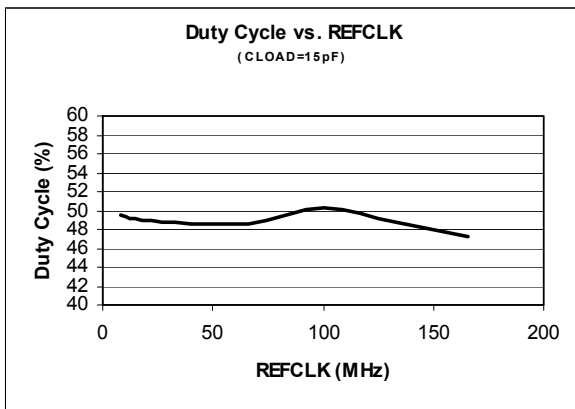
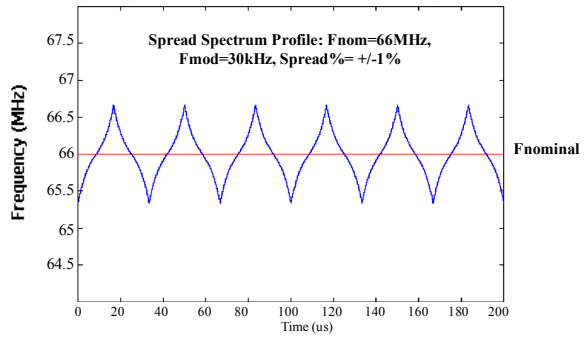
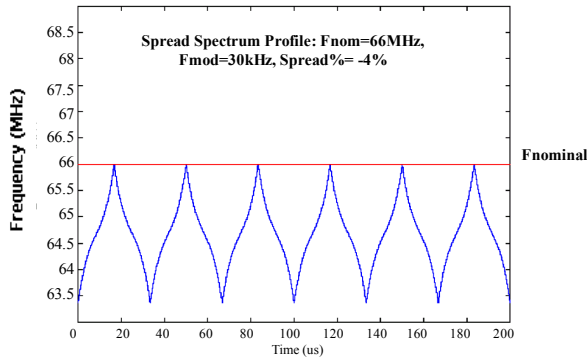
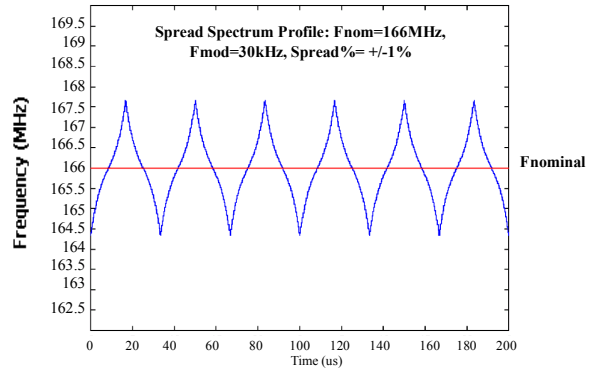
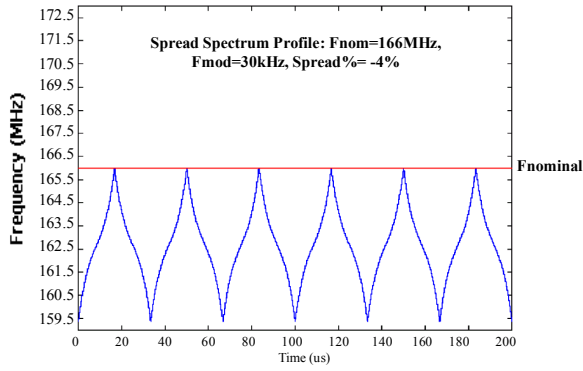

Figure 6. Output Enable/Disable Timing



### Informational Graphs

The Informational Graphs are as follows. [7]



**Note**

7. The Informational Graphs are meant to convey the typical performance levels. No performance specifications is implied or guaranteed. Refer to [DC Electrical Characteristics](#) on page 6 and [AC Electrical Characteristics](#) on page 7 for device specifications.

**Informational Graphs** (continued)

The Informational Graphs are as follows. [7]

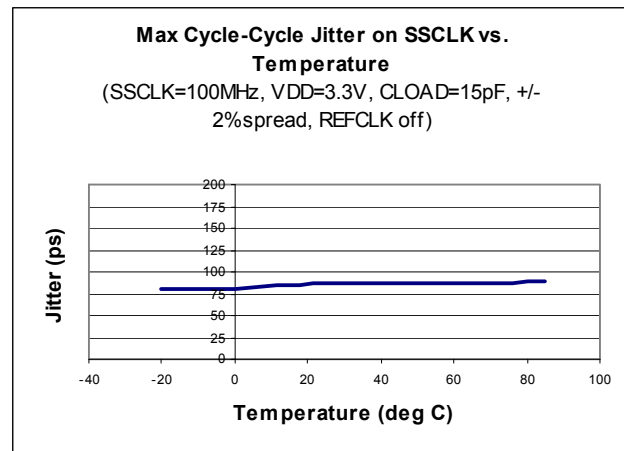
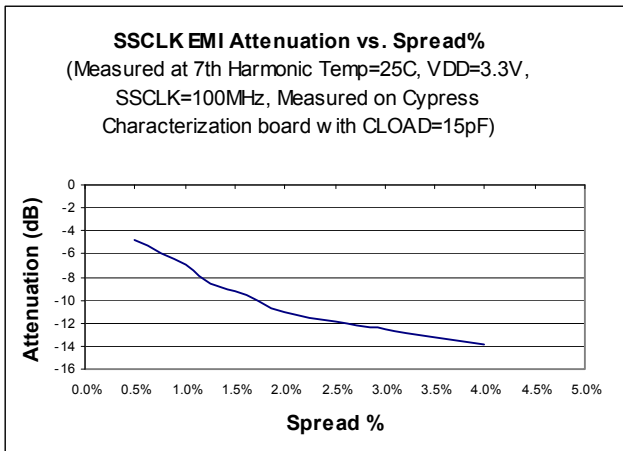
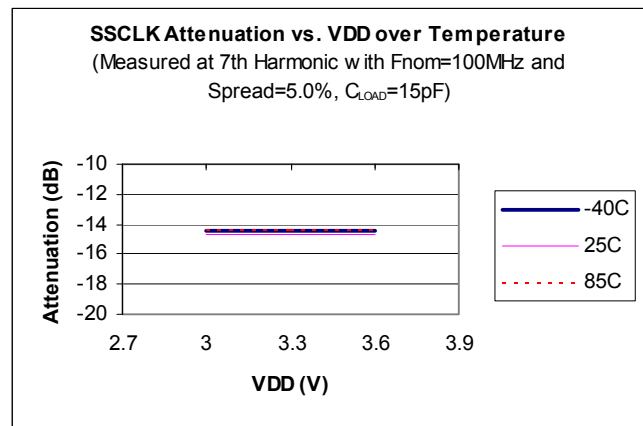
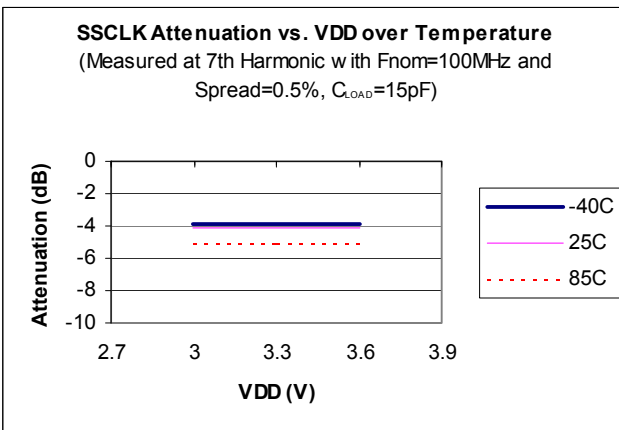
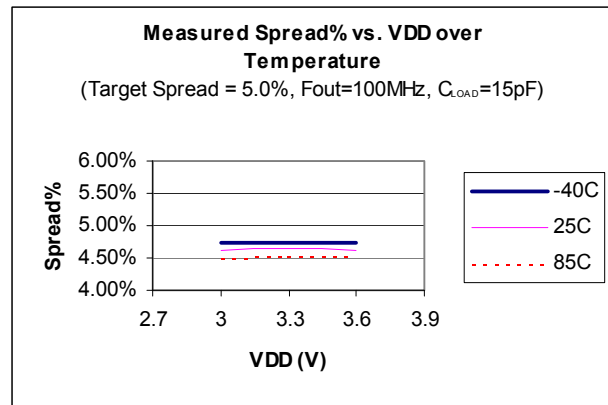
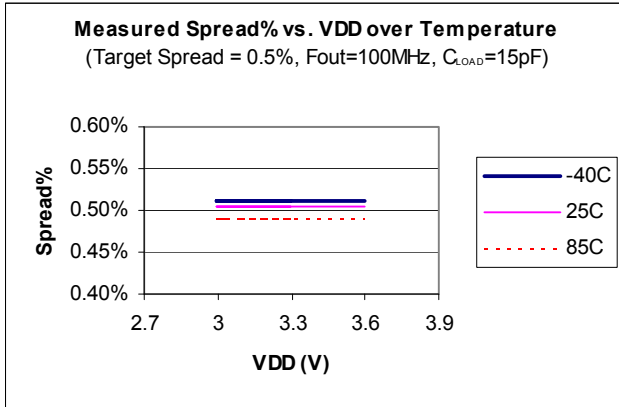

## Ordering Information

Ordering Code	Package Description	Product Flow
<b>Pb-free</b>		
CY25100SXCF	8-pin Small Outline Integrated Circuit (SOIC)	Commercial, 0 °C to 70 °C
CY25100SXCF T	8-pin Small Outline Integrated Circuit (SOIC) - Tape and Reel	Commercial, 0 °C to 70 °C
CY25100SXIF	8-pin Small Outline Integrated Circuit (SOIC)	Industrial, -40 °C to 85 °C
CY25100SXIF T	8-pin Small Outline Integrated Circuit (SOIC) - Tape and Reel	Industrial, -40 °C to 85 °C
CY25100ZXC F	8-pin Thin Shrunk Small Outline Package (TSSOP)	Commercial, 0 °C to 70 °C
CY25100ZXC F T	8-pin Thin Shrunk Small Outline Package (TSSOP) - Tape and Reel	Commercial, 0 °C to 70 °C
CY25100ZXIF	8-pin Thin Shrunk Small Outline Package (TSSOP)	Industrial, -40 °C to 85 °C
CY25100ZXIF T	8-pin Thin Shrunk Small Outline Package (TSSOP) - Tape and Reel	Industrial, -40 °C to 85 °C
<b>Programmer</b>		
CY3672-USB	Programmer, for devices with ordering codes ending in "F" and "FT"	
CY3690	CY25100ZXC F/IF Adapter (TSSOP) for CY3672-USB Programmer	
CY3691	CY25100SXCF/IF Adapter (SOIC) for CY3672-USB Programmer	

Some product offerings are factory programmed customer specific devices with customized part numbers. The Possible Configurations table shows the available device types, but not complete part numbers. Contact your local Cypress FAE or Sales Representative for more information.

## Possible Configurations

Ordering Code	Package Description	Product Flow
CY25100ZI-xxx <sup>[8, 9]</sup>	8-pin Thin Shrunk Small Outline Package (TSSOP)	Industrial, -40 °C to 85 °C
CY25100ZI-xxx T <sup>[8, 9]</sup>	8-pin Thin Shrunk Small Outline Package (TSSOP) -Tape and Reel	Industrial, -40 °C to 85 °C
<b>Pb-free</b>		
CY25100SXC-xxx <sup>[8]</sup>	8-pin Small Outline Integrated Circuit (SOIC)	Commercial, 0 °C to 70 °C
CY25100SXC-xxx T <sup>[8]</sup>	8-pin Small Outline Integrated Circuit (SOIC) - Tape and Reel	Commercial, 0 °C to 70 °C
CY25100SXI-xxx <sup>[8]</sup>	8-pin Small Outline Integrated Circuit (SOIC)	Industrial, -40 °C to 85 °C
CY25100SXI-xxx T <sup>[8]</sup>	8-pin Small Outline Integrated Circuit (SOIC) -Tape and Reel	Industrial, -40 °C to 85 °C
CY25100ZXC-xx <sup>[8]</sup>	8-pin Thin Shrunk Small Outline Package (TSSOP)	Commercial, 0 °C to 70 °C
CY25100ZXC-xx T <sup>[8]</sup>	8-pin Thin Shrunk Small Outline Package (TSSOP) - Tape and Reel	Commercial, 0 °C to 70 °C
CY25100ZXI-xx <sup>[8]</sup>	8-pin Thin Shrunk Small Outline Package (TSSOP)	Industrial, -40 °C to 85 °C
CY25100ZXI-xx T <sup>[8]</sup>	8-pin Thin Shrunk Small Outline Package (TSSOP) -Tape and Reel	Industrial, -40 °C to 85 °C

### Note

8. Ordering codes with "xxx" or "xx" are factory-programmed configurations. "xxx" or "xx" denotes the specific device configuration. "w" denotes the revision. Factory programming is available for high-volume orders. For more details, contact your local Cypress field application engineer or Cypress Sales Representative.
9. Not recommended for new designs. New designs should use Pb-free devices.

**Ordering Code Definitions**

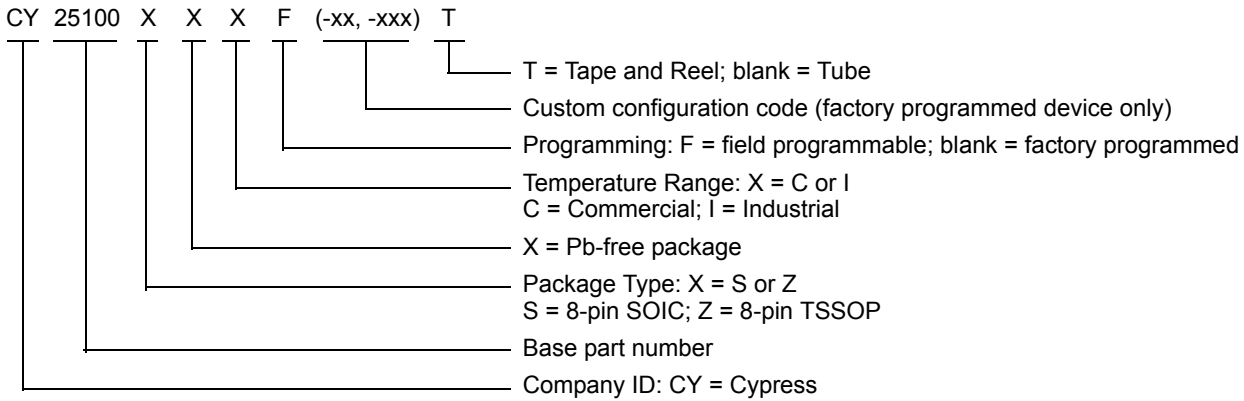

**Package Diagrams**

**Figure 7. 8-pin SOIC (150-Mils) S08.15/SZ08.15**

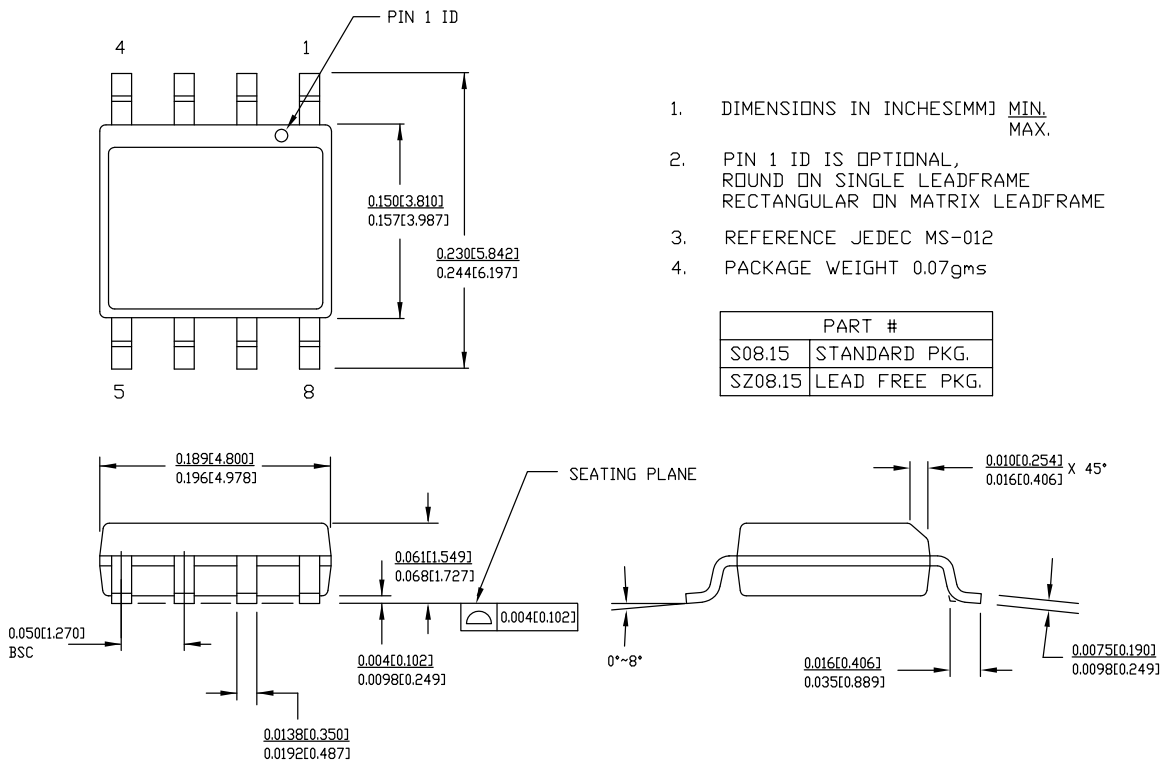

51-85066 \*E

Package Diagrams (continued)

Figure 7. 8-pin TSSOP (4.40 mm Body) Z08.173/ZZ08.173

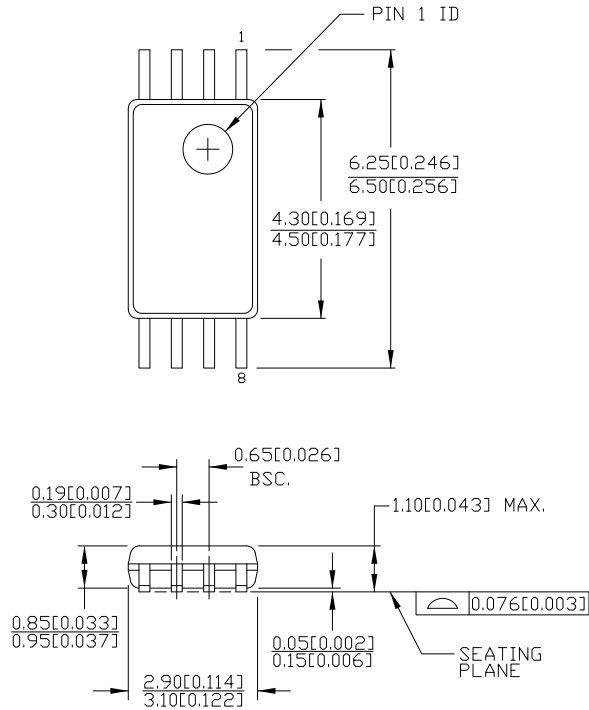

DIMENSIONS IN MM[INCHES] MIN. MAX.

REFERENCE JEDEC MO-153

PART #	
Z08.173	STANDARD PKG.
ZZ08.173	LEAD FREE PKG.

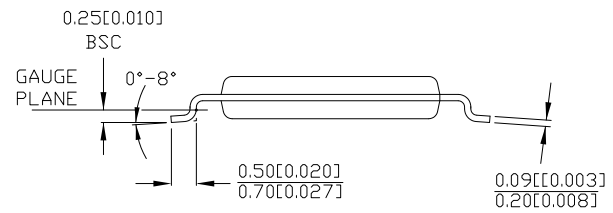

51-85093 °C

## Acronyms

Acronym	Description
DC	direct current
EMI	electromagnetic interference
ESR	equivalent series resistance
FAE	field application engineer
JEDEC	joint electron devices engineering council
OE	output enable
PCB	printed circuit board
PD	power down
PLL	phase locked loop
SOIC	small outline integrated circuit
SSC	spread spectrum clock
SSCG	spread spectrum clock generator
TSSOP	thin shrunk small outline package

## Document Conventions

### Units of Measure

Symbol	Unit of Measure
°C	degree Celsius
kHz	kilohertz
MHz	megahertz
μA	microampere
μF	microfarad
mA	milliampere
mm	millimeter
ms	millisecond
mW	milliwatt
ns	nanosecond
Ω	ohm
%	percent
pF	picofarad
ps	picosecond
V	volt

Document History Page

Document Title: CY25100, Field and Factory Programmable Spread Spectrum Clock Generator for EMI Reduction Document Number: 38-07499				
Rev.	ECN No.	Orig. of Change	Submission Date	Description of Change
**	126578	CKN	06/27/03	New Data Sheet
*A	128753	IJATMP	08/29/03	Changes to reflect field programmability
*B	130342	RGL	12/02/03	Changes to Application Circuit diagram and correction to the package description listed under the Ordering Information table for CY3690 and CY3691.
*C	204121	RGL	See ECN	Add Industrial Temperature Range Corrected the Ordering Information to match the DevMaster
*D	215392	RGL	See ECN	Added Lead Free devices
*E	2513909	AESA	06/10/08	Updated template. Added Note "Not recommended for new designs." Added part number CY25100KSXCF, CY25100KSXIF, CY25100KSXI-xxx, CY25100KZXC-xxx, CY25100KZXI-xxx, CY25100KSXI-xxxT, CY25100KZXC-xxxT, CY25100KZXI-xxxT, and CY25100KZXIF in ordering information table. Added Pb-Free header in the ordering information table. Removed Pb-Free from Package description in the ordering information table. Changed CY3672-PRG with CY3672-USB in the ordering information table. Removed CY25100SCF, CY25100SIF, CY25100ZCF, CY25100ZIF, and CY3672 in the ordering information table. Changed Lead free to Pb-Free.
*F	2601881	KVM / PYRS	11/06/08	Rising edge slew rate (SR3) minimum limit changed from 1.2 V/ns to 1.0 V/ns. Removed part numbers added in rev *E.
*G	2742910	KVM	07/23/09	General text cleanup Moved General Description to p. 1 to replace the Benefits section Removed "FTG" from references to CY3672 Added "Type" column to Pin Description table Revised software description section Revised Modulation Frequency section to remove mention of optional modulation frequencies Added minimum values to I <sub>IH</sub> and I <sub>IL</sub> Added to I <sub>OZ</sub> conditions: applies only for output pulldown disabled Standardized timing parameter names to upper case Corrected some part numbers to remove dashes and revision code Added part numbers to the Ordering Information table: CY25100ZI-xxx, CY25100ZI-xxxT, CY25100SXCFT, CY25100SXIFT, CY25100ZXCFT and CY25100ZXIFT Revised Ordering Information table footnotes
*H	2897317	KVM	03/22/10	Removed obsolete parts from Ordering Information table and moved 'xxx' parts to Possible Configurations table Updated package diagrams
*I	3366141	PURU	09/12/2011	Updated <a href="#">Logic Block Diagram</a> . Added <a href="#">Ordering Code Definitions</a> . Updated <a href="#">Package Diagrams</a> . Added <a href="#">Acronyms</a> and <a href="#">Units of Measure</a> . Updated in new template.



## Sales, Solutions, and Legal Information

### Worldwide Sales and Design Support

Cypress maintains a worldwide network of offices, solution centers, manufacturer's representatives, and distributors. To find the office closest to you, visit us at [Cypress Locations](#).

### Products

<a href="#">Automotive</a>	<a href="http://cypress.com/go/automotive">cypress.com/go/automotive</a>
<a href="#">Clocks &amp; Buffers</a>	<a href="http://cypress.com/go/clocks">cypress.com/go/clocks</a>
<a href="#">Interface</a>	<a href="http://cypress.com/go/interface">cypress.com/go/interface</a>
<a href="#">Lighting &amp; Power Control</a>	<a href="http://cypress.com/go/powerpsoc">cypress.com/go/powerpsoc</a> <a href="http://cypress.com/go/plc">cypress.com/go/plc</a>
<a href="#">Memory</a>	<a href="http://cypress.com/go/memory">cypress.com/go/memory</a>
<a href="#">Optical &amp; Image Sensing</a>	<a href="http://cypress.com/go/image">cypress.com/go/image</a>
<a href="#">PSoC</a>	<a href="http://cypress.com/go/psoc">cypress.com/go/psoc</a>
<a href="#">Touch Sensing</a>	<a href="http://cypress.com/go/touch">cypress.com/go/touch</a>
<a href="#">USB Controllers</a>	<a href="http://cypress.com/go/USB">cypress.com/go/USB</a>
<a href="#">Wireless/Rf</a>	<a href="http://cypress.com/go/wireless">cypress.com/go/wireless</a>

### PSoC Solutions

[psoc.cypress.com/solutions](http://psoc.cypress.com/solutions)  
PSoC 1 | PSoC 3 | PSoC 5

---

© Cypress Semiconductor Corporation, 2003-2011. The information contained herein is subject to change without notice. Cypress Semiconductor Corporation assumes no responsibility for the use of any circuitry other than circuitry embodied in a Cypress product. Nor does it convey or imply any license under patent or other rights. Cypress products are not warranted nor intended to be used for medical, life support, life saving, critical control or safety applications, unless pursuant to an express written agreement with Cypress. Furthermore, Cypress does not authorize its products for use as critical components in life-support systems where a malfunction or failure may reasonably be expected to result in significant injury to the user. The inclusion of Cypress products in life-support systems application implies that the manufacturer assumes all risk of such use and in doing so indemnifies Cypress against all charges.

Any Source Code (software and/or firmware) is owned by Cypress Semiconductor Corporation (Cypress) and is protected by and subject to worldwide patent protection (United States and foreign), United States copyright laws and international treaty provisions. Cypress hereby grants to licensee a personal, non-exclusive, non-transferable license to copy, use, modify, create derivative works of, and compile the Cypress Source Code and derivative works for the sole purpose of creating custom software and or firmware in support of licensee product to be used only in conjunction with a Cypress integrated circuit as specified in the applicable agreement. Any reproduction, modification, translation, compilation, or representation of this Source Code except as specified above is prohibited without the express written permission of Cypress.

Disclaimer: CYPRESS MAKES NO WARRANTY OF ANY KIND, EXPRESS OR IMPLIED, WITH REGARD TO THIS MATERIAL, INCLUDING, BUT NOT LIMITED TO, THE IMPLIED WARRANTIES OF MERCHANTABILITY AND FITNESS FOR A PARTICULAR PURPOSE. Cypress reserves the right to make changes without further notice to the materials described herein. Cypress does not assume any liability arising out of the application or use of any product or circuit described herein. Cypress does not authorize its products for use as critical components in life-support systems where a malfunction or failure may reasonably be expected to result in significant injury to the user. The inclusion of Cypress' product in a life-support systems application implies that the manufacturer assumes all risk of such use and in doing so indemnifies Cypress against all charges.

Use may be limited by and subject to the applicable Cypress software license agreement.