

Features

- Very high speed: 45 ns
 - Wide voltage range: 2.20 V–3.60 V
- Pin compatible with CY62158DV30
- Ultra low standby power
 - Typical standby current: 2 μ A
 - Maximum standby current: 8 μ A
- Ultra low active power
 - Typical active current: 1.8 mA at $f = 1$ MHz
- Easy memory expansion with \overline{CE}_1 , CE_2 , and \overline{OE} features
- Automatic power down when deselected
- CMOS for optimum speed/power
- Offered in Pb-free 48-ball VFBGA and 44-pin TSOP II packages

Functional Description

The CY62158EV30 is a high performance CMOS static RAM organized as 1024K words by 8 bits. This device features advanced circuit design to provide ultra low active current. This is ideal for providing More Battery Life™ (MoBL[®]) in portable applications such as cellular telephones. The device also has an automatic power down feature that significantly reduces power consumption. Placing the device into standby mode reduces power consumption significantly when deselected (\overline{CE}_1 HIGH or CE_2 LOW). The eight input and output pins (I/O_0 through I/O_7) are placed in a high impedance state when the device is deselected (\overline{CE}_1 HIGH or CE_2 LOW), the outputs are disabled (\overline{OE} HIGH), or a write operation is in progress (\overline{CE}_1 LOW and CE_2 HIGH and WE LOW).

To write to the device, take Chip Enables (\overline{CE}_1 LOW and CE_2 HIGH) and Write Enable (WE) input LOW. Data on the eight I/O pins (I/O_0 through I/O_7) is then written into the location specified on the address pins (A_0 through A_{19}).

To read from the device, take Chip Enables (\overline{CE}_1 LOW and CE_2 HIGH) and \overline{OE} LOW while forcing the WE HIGH. Under these conditions, the contents of the memory location specified by the address pins appear on the I/O pins. See [Truth Table on page 10](#) for a complete description of read and write modes.

Logic Block Diagram

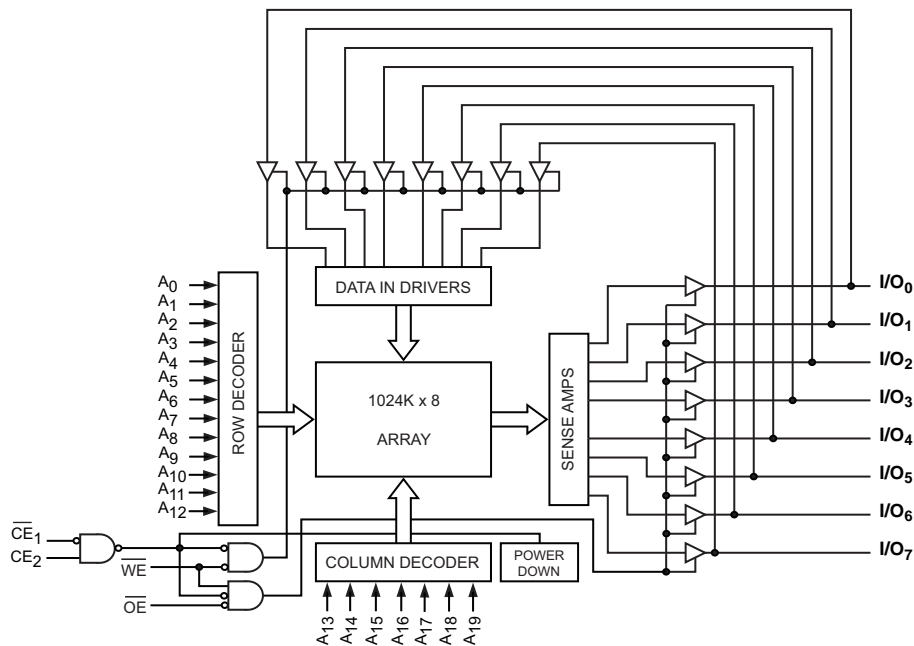

Contents

Pin Configurations	3	Write Cycle No. 2 (<u>CE</u> 1 or <u>CE</u> 2 Controlled)	9
Product Portfolio	3	Write Cycle No. 3 (<u>WE</u> Controlled, <u>OE</u> LOW)	10
Maximum Ratings	4	Truth Table	10
Operating Range	4	Ordering Information	11
Electrical Characteristics	4	Ordering Code Definitions	11
Capacitance	5	Package Diagrams	12
Thermal Resistance	5	Acronyms	14
AC Test Loads and Waveforms	5	Document Conventions	14
Data Retention Characteristics	6	Units of Measure	14
Data Retention Waveform	6	Document History Page	15
Switching Characteristics	7	Sales, Solutions, and Legal Information	16
Switching Waveforms	8	Worldwide Sales and Design Support	16
Read Cycle No. 1 (Address Transition Controlled)	8	Products	16
Read Cycle No. 2 (<u>OE</u> Controlled)	8	PSoC Solutions	16
Write Cycle No. 1 (<u>WE</u> Controlled)	9		

Pin Configurations ^[1]

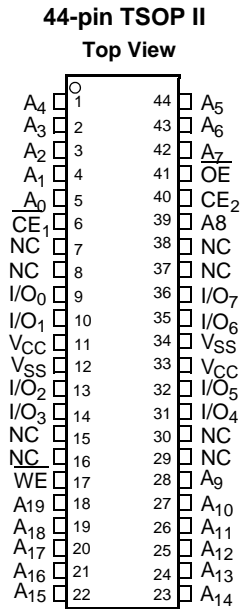
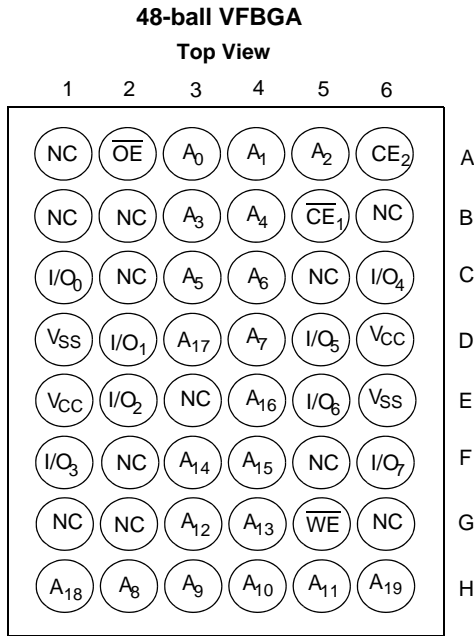

Product Portfolio

Product	V _{CC} Range (V)			Speed (ns)	Power Dissipation					
					Operating I _{CC} (mA)				Standby, I _{SB2} (μA)	
	f = 1 MHz		f = f _{max}							
	Min	Typ ^[2]	Max		Typ ^[2]	Max	Typ ^[2]	Max	Typ ^[2]	Max
CY62158EV30LL	2.2	3.0	3.6	45	1.8	3	18	25	2	8

Notes

1. NC pins are not connected on the die.
2. Typical values are included for reference only and are not guaranteed or tested. Typical values are measured at V_{CC} = V_{CC(typ)}, T_A = 25 °C.

Maximum Ratings

Exceeding maximum ratings may shorten the useful life of the device. User guidelines are not tested.

Storage Temperature	-65 °C to +150 °C
Ambient Temperature with Power Applied	-55 °C to +125 °C
Supply Voltage to Ground Potential	-0.3 V to $V_{CC(max)} + 0.3$ V
DC Voltage Applied to Outputs in High Z State ^[3, 4]	-0.3 V to $V_{CC(max)} + 0.3$ V

DC Input Voltage ^[3, 4]	-0.3 V to $V_{CC(max)} + 0.3$ V
Output Current into Outputs (LOW)	20 mA
Static Discharge Voltage	> 2001 V (MIL-STD-883, Method 3015)
Latch up Current	> 200 mA

Operating Range

Product	Range	Ambient Temperature (T _A)	V _{CC} ^[5]
CY62158EV30LL	Industrial	-40 °C to +85 °C	2.2 V–3.6 V

Electrical Characteristics

Over the Operating Range

Parameter	Description	Test Conditions	45 ns			Unit
			Min	Typ ^[6]	Max	
V _{OH}	Output HIGH voltage	I _{OH} = -0.1 mA	2.0	-	-	V
		I _{OH} = -1.0 mA, V _{CC} ≥ 2.70 V	2.4	-	-	V
V _{OL}	Output LOW voltage	I _{OL} = 0.1 mA	-	-	0.4	V
		I _{OL} = 2.1 mA, V _{CC} ≥ 2.70 V	-	-	0.4	V
V _{IH}	Input HIGH voltage	V _{CC} = 2.2 V to 2.7 V	1.8	-	V _{CC} + 0.3 V	V
		V _{CC} = 2.7 V to 3.6 V	2.2	-	V _{CC} + 0.3 V	V
V _{IIL}	Input LOW voltage	V _{CC} = 2.2 V to 2.7 V	-0.3	-	0.6	V
		V _{CC} = 2.7 V to 3.6 V	-0.3	-	0.8	V
I _{IX}	Input leakage current	GND ≤ V _I ≤ V _{CC}	-1	-	+1	μA
I _{OZ}	Output leakage current	GND ≤ V _O ≤ V _{CC} , Output Disabled	-1	-	+1	μA
I _{CC}	V _{CC} operating supply current	f = f _{max} = 1/t _{RC}	-	18	25	mA
		f = 1 MHz	-	1.8	3	mA
I _{SB1}	Automatic CE power down current — CMOS Inputs	$\overline{CE}_1 \geq V_{CC} - 0.2$ V, CE ₂ ≤ 0.2 V, V _{IN} ≥ V _{CC} - 0.2 V, V _{IN} ≤ 0.2 V, f = f _{max} (Address and Data Only), f = 0 (OE and WE), V _{CC} = 3.60 V	-	2	8	μA
I _{SB2} ^[7]	Automatic CE Power down Current — CMOS inputs	$\overline{CE}_1 \geq V_{CC} - 0.2$ V or CE ₂ ≤ 0.2 V, V _{IN} ≥ V _{CC} - 0.2 V or V _{IN} ≤ 0.2 V, f = 0, V _{CC} = 3.60 V	-	2	8	μA

Notes

- V_{I(L)(min)} = -2.0 V for pulse durations less than 20 ns.
- V_{I(H)(max)} = V_{CC} + 0.75 V for pulse duration less than 20 ns.
- Full device AC operation assumes a 100 μs ramp time from 0 to V_{CC(min)} and 200 μs wait time after V_{CC} stabilization.
- Typical values are included for reference only and are not guaranteed or tested. Typical values are measured at V_{CC} = V_{CC(typ)}, T_A = 25 °C.
- Chip enables (CE₁ and CE₂) must be at CMOS level to meet the I_{SB2} / I_{CCDR} spec. Other inputs can be left floating.

Capacitance

Parameter ^[8]	Description	Test Conditions	Max	Unit
C _{IN}	Input capacitance	T _A = 25 °C, f = 1 MHz, V _{CC} = V _{CC(typ)}	10	pF
C _{OUT}	Output capacitance		10	pF

Thermal Resistance

Parameter ^[8]	Description	Test Conditions	48-ball BGA	44-pin TSOP II	Unit
Θ _{JA}	Thermal resistance (junction to ambient)	Still Air, soldered on a 3 × 4.5 inch, two-layer printed circuit board	72	76.88	°C/W
Θ _{JC}	Thermal resistance (junction to case)		8.86	13.52	°C/W

AC Test Loads and Waveforms

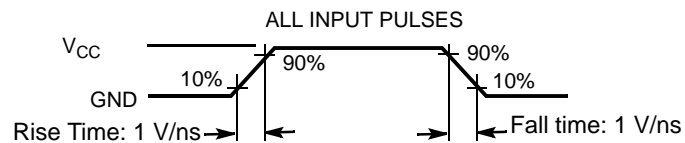
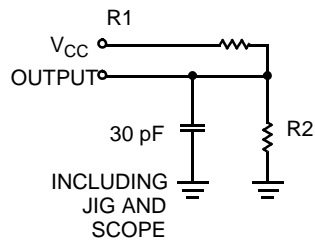

Equivalent to: THÉVENIN EQUIVALENT

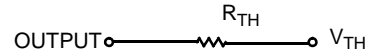

Parameters	2.5 V	3.0 V	Unit
R ₁	16667	1103	Ω
R ₂	15385	1554	Ω
R _{TH}	8000	645	Ω
V _{TH}	1.20	1.75	V

Note

8. Tested initially and after any design or process changes that may affect these parameters.

Data Retention Characteristics

Over the Operating Range

Parameter	Description	Conditions	Min	Typ ^[9]	Max	Unit
V_{DR}	V_{CC} for data retention		1.5	–	–	V
I_{CCDR} ^[10]	Data retention current	$V_{CC} = 1.5\text{ V}$, $\overline{CE}_1 \geq V_{CC} - 0.2\text{ V}$ or $CE_2 \leq 0.2\text{ V}$, $V_{IN} \geq V_{CC} - 0.2\text{ V}$ or $V_{IN} \leq 0.2\text{ V}$	–	2	5	μA
t_{CDR} ^[11]	Chip deselect to data retention time		0	–	–	ns
t_R ^[12]	Operation recovery time		45	–	–	ns

Data Retention Waveform

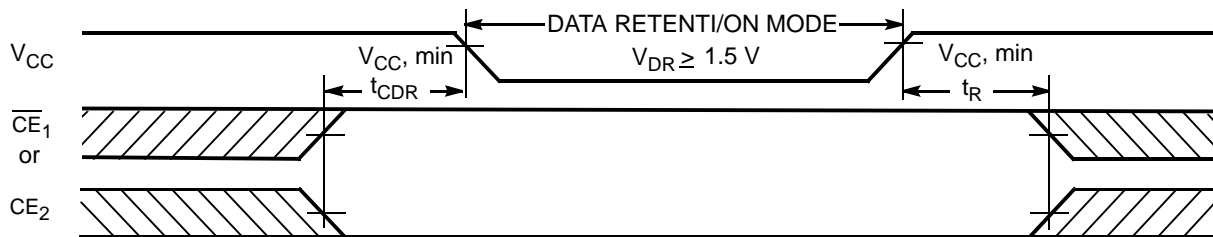

Notes

9. Typical values are included for reference only and are not guaranteed or tested. Typical values are measured at $V_{CC} = V_{CC(\text{typ})}$, $T_A = 25\text{ }^\circ\text{C}$.
10. Chip enables (\overline{CE}_1 and CE_2) must be at CMOS level to meet the I_{SB2} / I_{CCDR} spec. Other inputs can be left floating.
11. Tested initially and after any design or process changes that may affect these parameters.
12. Full Device AC operation requires linear V_{CC} ramp from V_{DR} to $V_{CC(\text{min})} \geq 100\text{ }\mu\text{s}$ or stable at $V_{CC(\text{min})} \geq 100\text{ }\mu\text{s}$.

Switching Characteristics

Over the Operating Range

Parameter ^[13]	Description	45 ns		Unit
		Min	Max	
Read Cycle				
t_{RC}	Read cycle time	45	–	ns
t_{AA}	Address to data valid	–	45	ns
t_{OHA}	Data Hold from address change	10	–	ns
t_{ACE}	\overline{CE}_1 LOW and CE_2 HIGH to data valid	–	45	ns
t_{DOE}	\overline{OE} LOW to data valid	–	22	ns
t_{LZOE}	\overline{OE} LOW to Low Z ^[14]	5	–	ns
t_{HZOE}	\overline{OE} HIGH to High Z ^[14, 15]	–	18	ns
t_{LZCE}	\overline{CE}_1 LOW and CE_2 HIGH to Low Z ^[14]	10	–	ns
t_{HZCE}	\overline{CE}_1 HIGH or CE_2 LOW to High Z ^[14, 15]	–	18	ns
t_{PU}	\overline{CE}_1 LOW and CE_2 HIGH to Power Up	0	–	ns
t_{PD}	\overline{CE}_1 HIGH or CE_2 LOW to Power Down	–	45	ns
Write Cycle^[16]				
t_{WC}	Write cycle time	45	–	ns
t_{SCE}	\overline{CE}_1 LOW and CE_2 HIGH to Write End	35	–	ns
t_{AW}	Address setup to Write End	35	–	ns
t_{HA}	Address Hold from Write End	0	–	ns
t_{SA}	Address setup to Write Start	0	–	ns
t_{PWE}	\overline{WE} pulse width	35	–	ns
t_{SD}	Data setup to Write End	25	–	ns
t_{HD}	Data Hold from Write End	0	–	ns
t_{HZWE}	\overline{WE} LOW to High Z ^[14, 15]	–	18	ns
t_{LZWE}	\overline{WE} HIGH to Low Z ^[14]	10	–	ns

Notes

13. Test conditions for all parameters other than tri-state parameters assume signal transition time of 3 ns or less (1V/ns), timing reference levels of $V_{CC(typ)}/2$, input pulse levels of 0 to $V_{CC(typ)}$, and output loading of the specified I_{OL}/I_{OH} as shown in [AC Test Loads and Waveforms on page 5](#).

14. At any given temperature and voltage condition, t_{HZCE} is less than t_{LZCE} , t_{HZOE} is less than t_{LZOE} , and t_{HZWE} is less than t_{LZWE} for any given device.

15. t_{HZOE} , t_{HZCE} , and t_{HZWE} transitions are measured when the outputs enter a high impedance state.

16. The internal write time of the memory is defined by the overlap of \overline{WE} , $\overline{CE}_1 = V_{IL}$, and $CE_2 = V_{IH}$. All signals must be ACTIVE to initiate a write and any of these signals can terminate a write by going INACTIVE. The data input setup and hold timing should be referenced to the edge of the signal that terminates the write.

Switching Waveforms

Read Cycle No. 1 (Address Transition Controlled)^[17, 18]

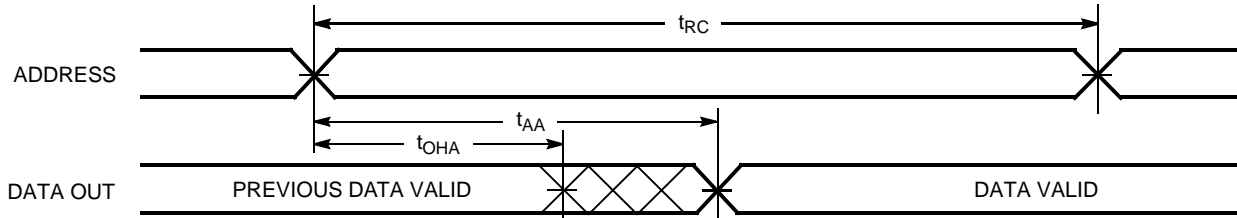

Read Cycle No. 2 ($\overline{\text{OE}}$ Controlled)^[18, 19]

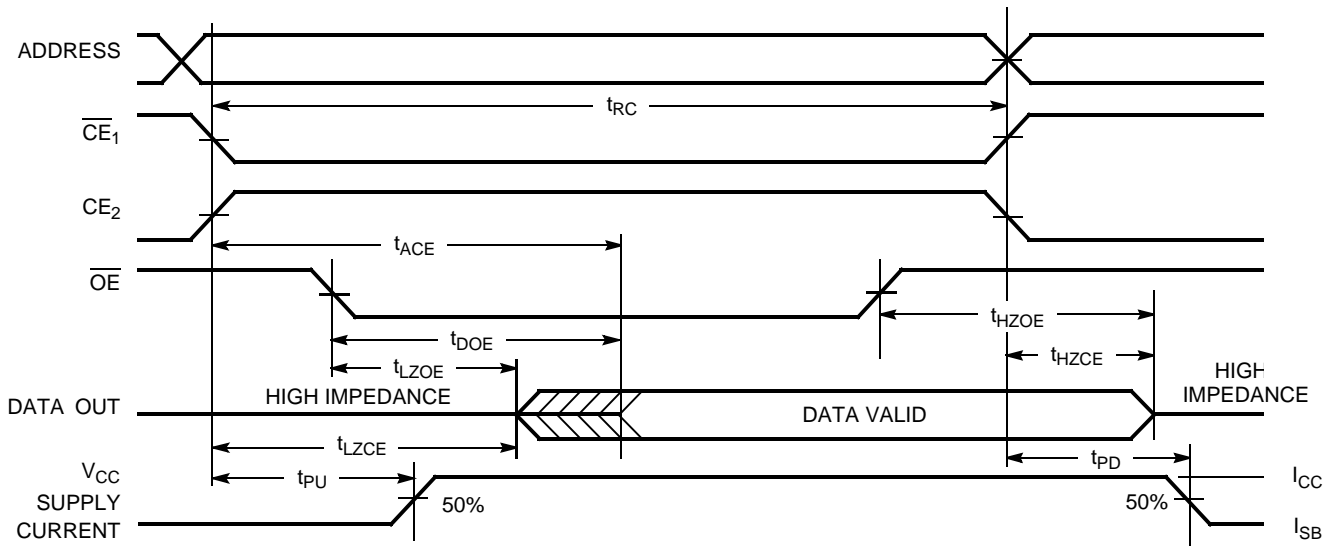

Notes

- 17. Device is continuously selected. $\overline{\text{OE}}$, $\overline{\text{CE}}_1 = V_{\text{IL}}$, $\text{CE}_2 = V_{\text{IH}}$.
- 18. WE is HIGH for read cycle.
- 19. Address valid before or similar to $\overline{\text{CE}}_1$ transition LOW and CE_2 transition HIGH.

Switching Waveforms (continued)

Write Cycle No. 1 (\overline{WE} Controlled)^[20, 21, 22]

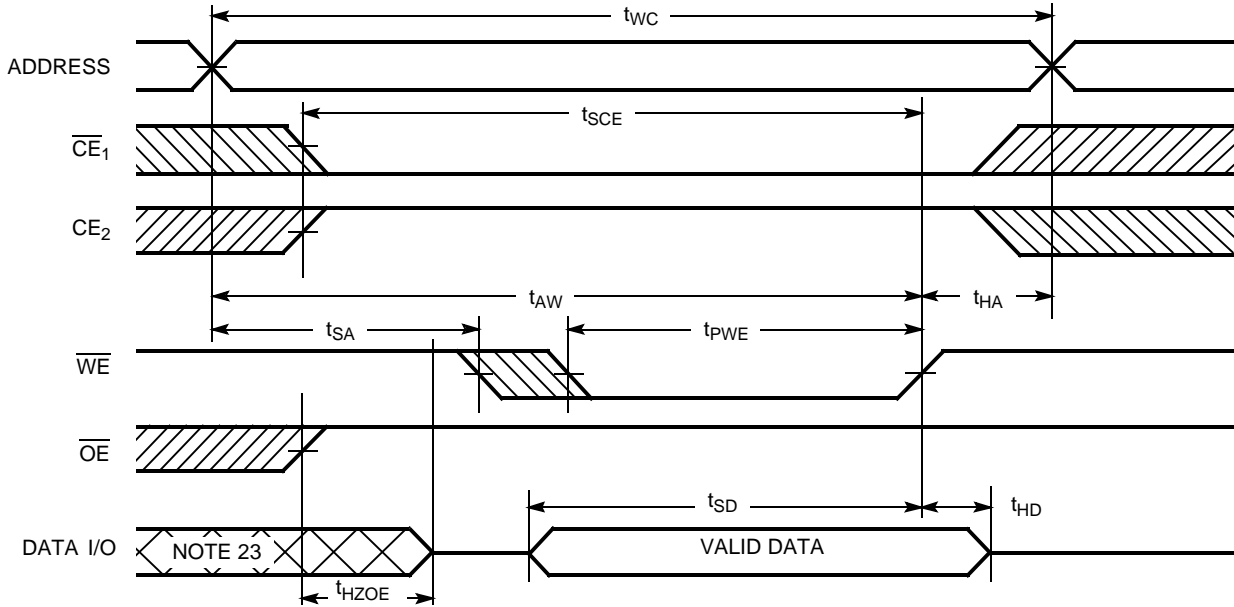

Write Cycle No. 2 (\overline{CE}_1 or CE_2 Controlled)^[20, 21, 22]

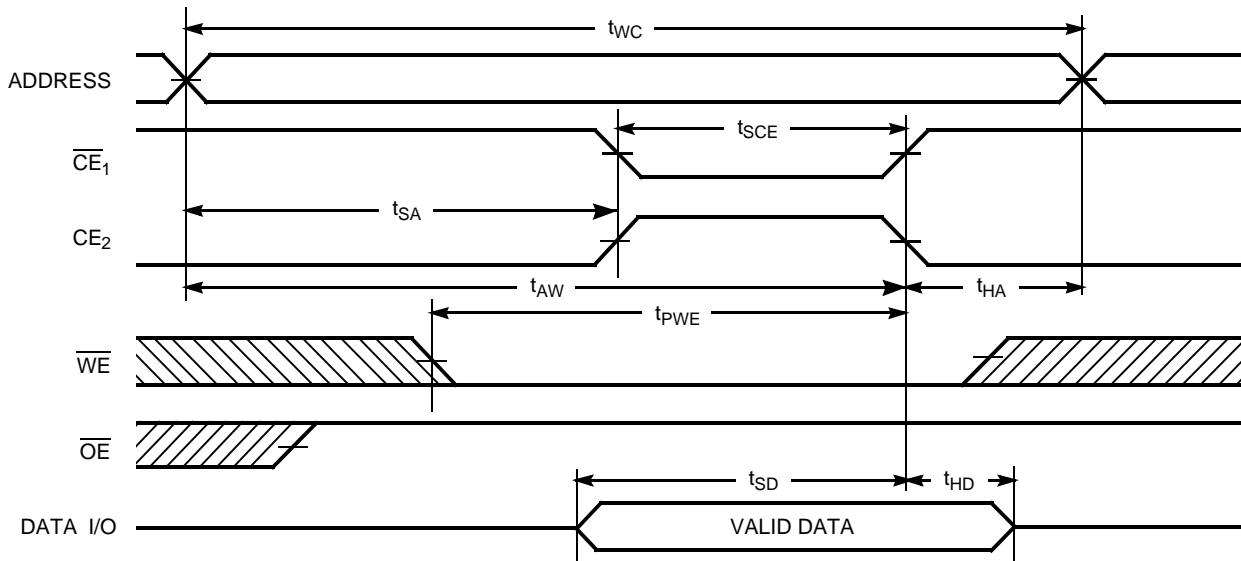

Notes

- 20. The internal write time of the memory is defined by the overlap of \overline{WE} , $\overline{CE}_1 = V_{IL}$, and $CE_2 = V_{IH}$. All signals must be ACTIVE to initiate a write and any of these signals can terminate a write by going INACTIVE. The data input setup and hold timing should be referenced to the edge of the signal that terminates the write.
- 21. Data I/O is high impedance if $\overline{OE} = V_{IH}$.
- 22. If \overline{CE}_1 goes HIGH or CE_2 goes LOW simultaneously with \overline{WE} HIGH, the output remains in high impedance state.
- 23. During this period, the I/Os are in output state. Do not apply input signals.

Switching Waveforms (continued)

Write Cycle No. 3 ($\overline{\text{WE}}$ Controlled, $\overline{\text{OE}}$ LOW)^[24]

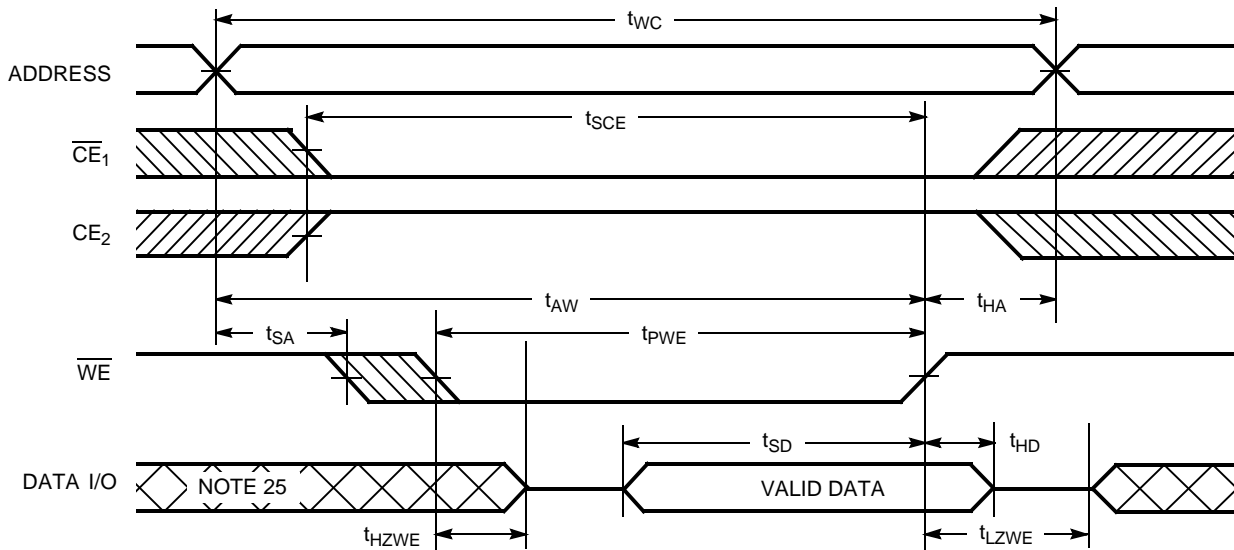

Truth Table

$\overline{\text{CE}}_1$	$\overline{\text{CE}}_2$	$\overline{\text{WE}}$	$\overline{\text{OE}}$	Inputs/Outputs	Mode	Power
H	X ^[26]	X	X	High Z	Deselect/Power down	Standby (I_{SB})
X ^[26]	L	X	X	High Z	Deselect/Power down	Standby (I_{SB})
L	H	H	L	Data Out	Read	Active (I_{CC})
L	H	L	X	Data In	Write	Active (I_{CC})
L	H	H	H	High Z	Selected, Outputs Disabled	Active (I_{CC})

Notes

24. If $\overline{\text{CE}}_1$ goes HIGH or $\overline{\text{CE}}_2$ goes LOW simultaneously with $\overline{\text{WE}}$ HIGH, the output remains in high impedance state.

25. During this period, the I/Os are in output state. Do not apply input signals.

26. The 'X' (Don't care) state for the Chip enables in the truth table refer to the logic state (either HIGH or LOW). Intermediate voltage levels on these pins is not permitted.

Ordering Information

Speed (ns)	Ordering Code	Package Diagram	Package Type	Operating Range
45	CY62158EV30LL-45BVXI	51-85150	48-ball Very Fine-Pitch Ball Grid Array (Pb-free)	Industrial
	CY62158EV30LL-45ZSXI	51-85087	44-pin Thin Small Outline Package Type II (Pb-free)	

Contact your local Cypress sales representative for availability of these parts.

Ordering Code Definitions

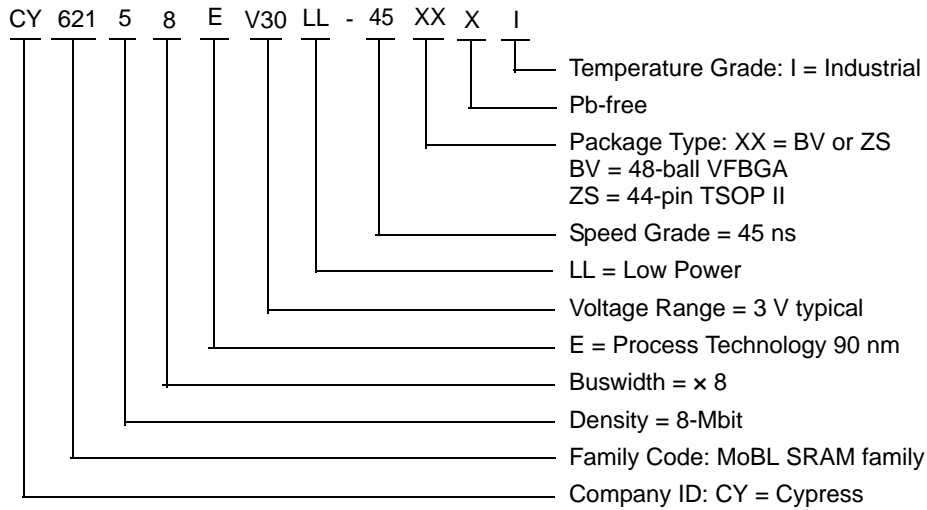

Package Diagrams

Figure 1. 48-ball VFBGA (6 × 8 × 1 mm) BV48/BZ48, 51-85150

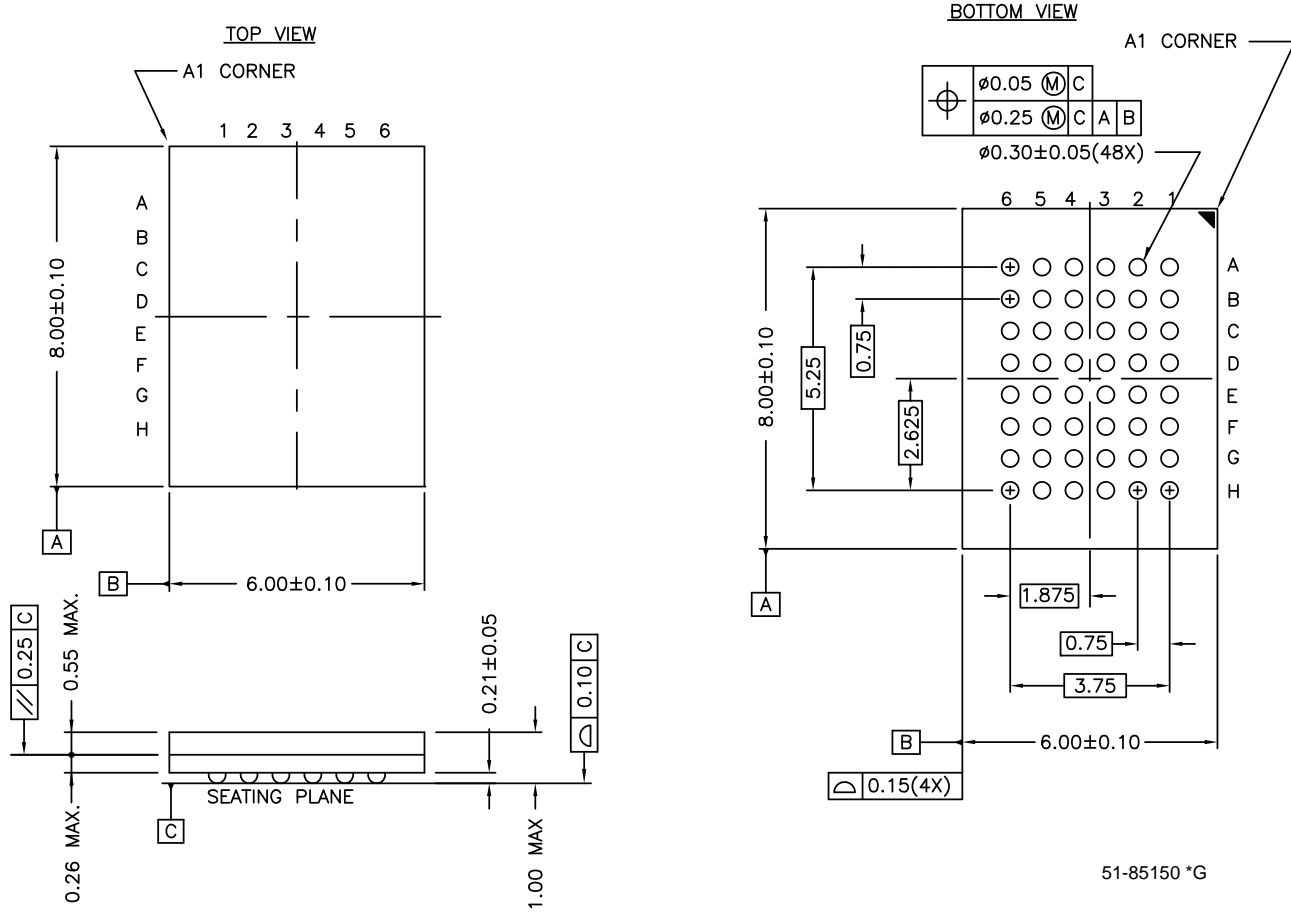

Package Diagrams (continued)

Figure 2. 44-pin TSOP Z44-II, 51-85087

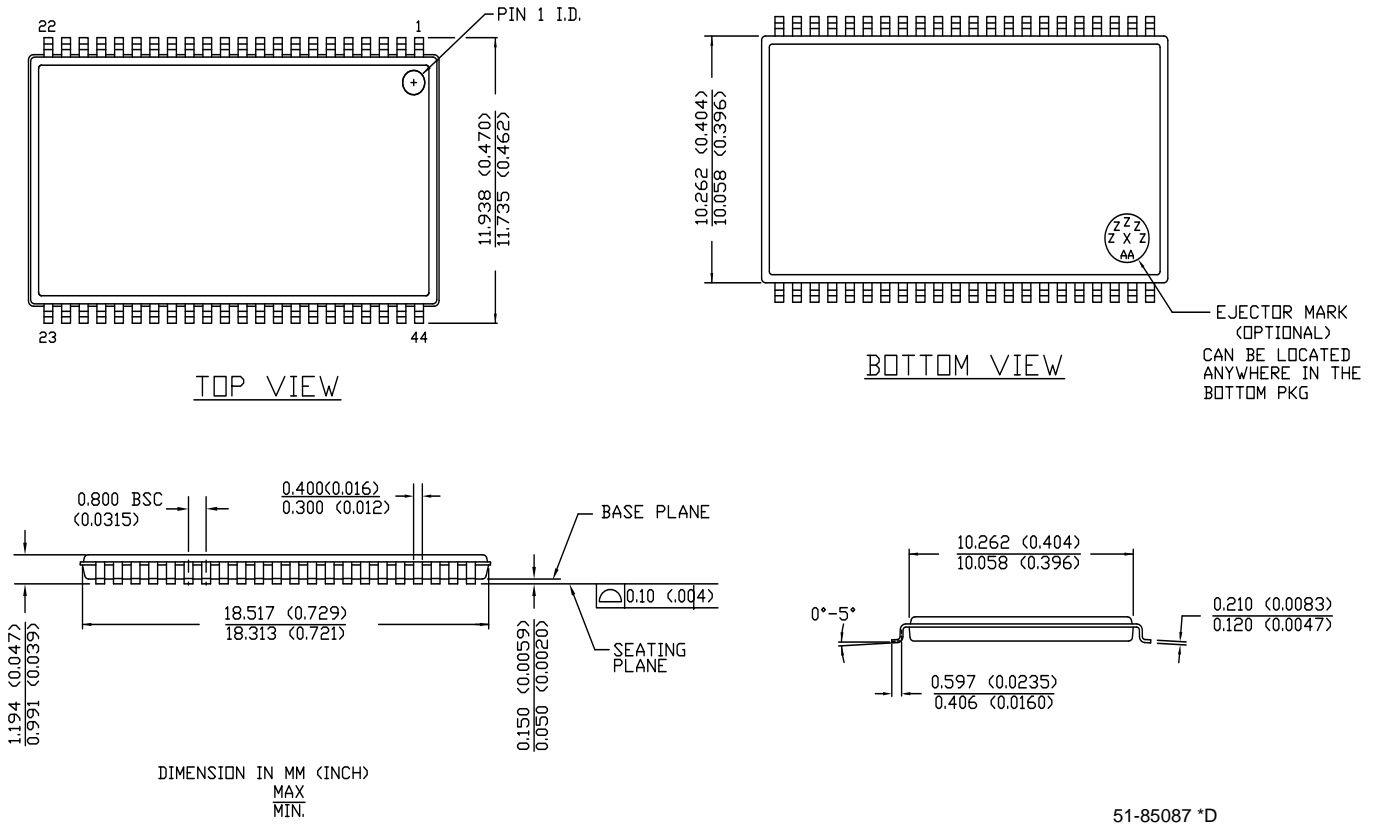

51-85087 *D

Acronyms

Acronym	Description
\overline{CE}	chip enable
CMOS	complementary metal oxide semiconductor
I/O	input/output
\overline{OE}	output enable
RAM	random access memory
SRAM	static random access memory
TTL	transistor-transistor logic
TSOP	thin small outline package
VFBGA	very fine-pitch ball grid array
\overline{WE}	write enable

Document Conventions

Units of Measure

Symbol	Unit of Measure
°C	degree Celcius
MHz	megahertz
μA	microampere
μs	microsecond
mA	milliampere
mm	millimeter
ns	nanosecond
Ω	ohm
%	percent
pF	picofarad
V	volt
W	watt

Document History Page

Document Title: CY62158EV30 MoBL [®] , 8-Mbit (1024 K x 8) Static RAM				
Document Number: 38-05578				
Rev.	ECN No.	Issue Date	Orig. of Change	Description of Change
**	270329	See ECN	PCI	New Data Sheet
*A	291271	See ECN	SYT	Converted from Advance Information to Preliminary Changed I _{CCDR} from 4 to 4.5 μA
*B	444306	See ECN	NXR	Converted from Preliminary to Final. Removed 35 ns speed bin Removed "L" bin. Removed 44 pin TSOP II package Included 48 pin TSOP I package Changed the I _{CC} Typ value from 16 mA to 18 mA and I _{CC} max value from 28 mA to 25 mA for test condition f = fax = 1/t _{RC} . Changed the I _{CC} max value from 2.3 mA to 3 mA for test condition f = 1MHz. Changed the I _{SB1} and I _{SB2} max value from 4.5 μA to 8 μA and Typ value from 0.9 μA to 2 μA respectively. Updated Thermal Resistance table Changed Test Load Capacitance from 50 pF to 30 pF. Added Typ value for I _{CCDR} . Changed the I _{CCDR} max value from 4.5 μA to 5 μA Corrected t _R in Data Retention Characteristics from 100 μs to t _{RC} ns Changed t _{LZOE} from 3 to 5 Changed t _{LZCE} from 6 to 10 Changed t _{HZCE} from 22 to 18 Changed t _{PWE} from 30 to 35 Changed t _{SD} from 22 to 25 Changed t _{LZWE} from 6 to 10 Updated the ordering Information and replaced the Package Name column with Package Diagram.
*C	467052	See ECN	NXR	Included 44 pin TSOP II package in Product Offering. Removed TSOP I package; Added reference to CY62157EV30 TSOP I Updated the ordering Information table
*D	1015643	See ECN	VKN	Added footnote #8 related to I _{SB2} and I _{CCDR}
*E	2934396	06/03/10	VKN	Added footnote #21 related to chip enable Updated package diagrams Updated template
*F	3110202	12/14/2010	PRAS	Updated Logic Block Diagram and Package Diagram. Added Ordering Code Definitions.
*G	3269641	05/30/2011	RAME	Updated Features . Removed the note "For best practice recommendations, refer to the Cypress application note "System Design Guidelines" at http://www.cypress.com." and its reference in Functional Description . Updated Data Retention Characteristics . Added Acronyms and Units of Measure . Updated in new template.
*H	3598409	04/24/2012	TAVA	Updated Package Diagram 51-85150 (from Rev *F to *G) and 51-85087 (from Rev *C to *D).

Sales, Solutions, and Legal Information

Worldwide Sales and Design Support

Cypress maintains a worldwide network of offices, solution centers, manufacturer's representatives, and distributors. To find the office closest to you, visit us at [Cypress Locations](#).

Products

Automotive	cypress.com/go/automotive
Clocks & Buffers	cypress.com/go/clocks
Interface	cypress.com/go/interface
Lighting & Power Control	cypress.com/go/powerpsoc cypress.com/go/plc
Memory	cypress.com/go/memory
Optical & Image Sensing	cypress.com/go/image
PSoC	cypress.com/go/psoc
Touch Sensing	cypress.com/go/touch
USB Controllers	cypress.com/go/USB
Wireless/RF	cypress.com/go/wireless

PSoC Solutions

psoc.cypress.com/solutions
PSoC 1 | PSoC 3 | PSoC 5

© Cypress Semiconductor Corporation, 2004-2012. The information contained herein is subject to change without notice. Cypress Semiconductor Corporation assumes no responsibility for the use of any circuitry other than circuitry embodied in a Cypress product. Nor does it convey or imply any license under patent or other rights. Cypress products are not warranted nor intended to be used for medical, life support, life saving, critical control or safety applications, unless pursuant to an express written agreement with Cypress. Furthermore, Cypress does not authorize its products for use as critical components in life-support systems where a malfunction or failure may reasonably be expected to result in significant injury to the user. The inclusion of Cypress products in life-support systems application implies that the manufacturer assumes all risk of such use and in doing so indemnifies Cypress against all charges.

Any Source Code (software and/or firmware) is owned by Cypress Semiconductor Corporation (Cypress) and is protected by and subject to worldwide patent protection (United States and foreign), United States copyright laws and international treaty provisions. Cypress hereby grants to licensee a personal, non-exclusive, non-transferable license to copy, use, modify, create derivative works of, and compile the Cypress Source Code and derivative works for the sole purpose of creating custom software and or firmware in support of licensee product to be used only in conjunction with a Cypress integrated circuit as specified in the applicable agreement. Any reproduction, modification, translation, compilation, or representation of this Source Code except as specified above is prohibited without the express written permission of Cypress.

Disclaimer: CYPRESS MAKES NO WARRANTY OF ANY KIND, EXPRESS OR IMPLIED, WITH REGARD TO THIS MATERIAL, INCLUDING, BUT NOT LIMITED TO, THE IMPLIED WARRANTIES OF MERCHANTABILITY AND FITNESS FOR A PARTICULAR PURPOSE. Cypress reserves the right to make changes without further notice to the materials described herein. Cypress does not assume any liability arising out of the application or use of any product or circuit described herein. Cypress does not authorize its products for use as critical components in life-support systems where a malfunction or failure may reasonably be expected to result in significant injury to the user. The inclusion of Cypress' product in a life-support systems application implies that the manufacturer assumes all risk of such use and in doing so indemnifies Cypress against all charges.

Use may be limited by and subject to the applicable Cypress software license agreement.