

HA22040

GaAs MMIC Down Converter for Micro Wave Application

HITACHI

ADE-207-318(Z)
1st. Edition
December 1999

Features

- Suitable for down converter of Micro Wave Application(1.5 GHz)
- Low voltage and low current operation (2.7V, 6mA typ.)
- High conversion gain (10.5 dB typ. @1489MHz)
- Low 3rd-order intercept point (IP3in=-0.5dBm typ, @1489MHz)
- Small surface mount package (MPAK-6)

Outline

MPAK-6

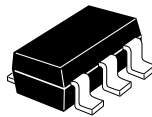

This Device is sensitive to Electro Static Discharge.
An Adequate handling procedure is requested.

CAUTION

This product uses GaAs. Since dust or fume of As, which is a component of GaAs, is highly poisonous to the human body, please do not treat them mechanically in the manner which might expose to the Air. And it should never be thrown out with general industrial or domestic wastes.

Absolute Maximum Ratings (Ta = 25°C)

Item	Symbol	Ratings	Unit
Supply voltage	Vdd	5	V
Maximum current	Idd	15	mA
Power dissipation	Pd	100	mW
Channel temperature	Tch	150	°C
Storage temperature	Tstg	-55 to +125	°C
Operation temperature	Topr	-20 to +70	°C
Maximum input power	Pin max	+15	dBm

Electrical Characteristics (Ta = 25°C, Vdd = 2.7V)

Item	Symbol	Min	Typ	Max	Unit	Test Conditions
Quiescent current	Idd	3.5	6	8.5	mA	No signal
Conversion gain	CG	8.5	10.5	12.5	dB	f=1489MHz, fLo=1619MHz, PLo=-12dBm, IF=130MHz, Pin=-30dBm
Noise figure	NF	—	4.5	6	dB	f=1489MHz, fLo=1619MHz, PLo=-12dBm, IF=130MHz

Typical Performance (Ta = 25°C, Vdd = 2.7V)

Item	Symbol	Typ	Unit	Test Conditions
VSWR (input)	VSWR in	1.5	—	f = 1.489 GHz
3rd order intercept point	IP3in	-0.5	dBm	f = 1.489 GHz, fud = 1.490 GHz, Pin=-30dBm, fLo=1.619GHz, PLo=-12dBm

Pin Arrangement

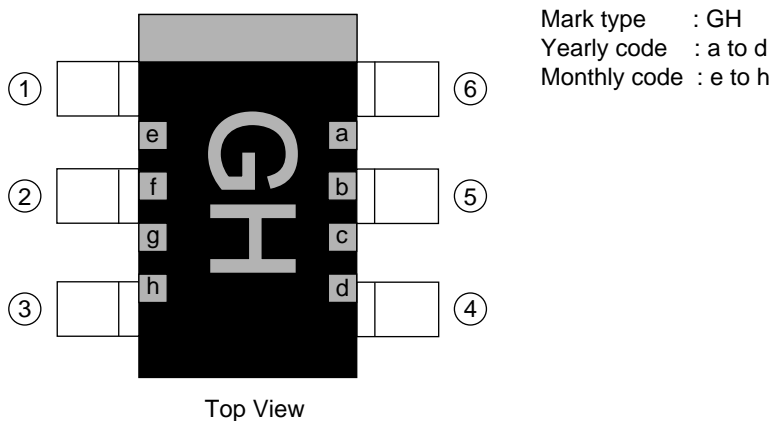

Yearly code

Year	Mark			
	a	b	c	d
1999	■	■	■	■
2000	■	■	■	■
2001	■	■	■	■
2002	■	■	■	■

Monthly code

Month	Mark			
	e	f	g	h
January	■	■	■	■
February	■	■	■	■
March	■	■	■	■
April	■	■	■	■
May	■	■	■	■
June	■	■	■	■
July	■	■	■	■
August	■	■	■	■
September	■	■	■	■
October	■	■	■	■
November	■	■	■	■
December	■	■	■	■

Pin No.	Pin name	Function
1	IF out	IF output
2	Cs	Bypass capacitor
3	RF in	RF input
4	Vdd	Voltage supply
5	GND	Ground
6	Lo in	Local input

Block Diagram

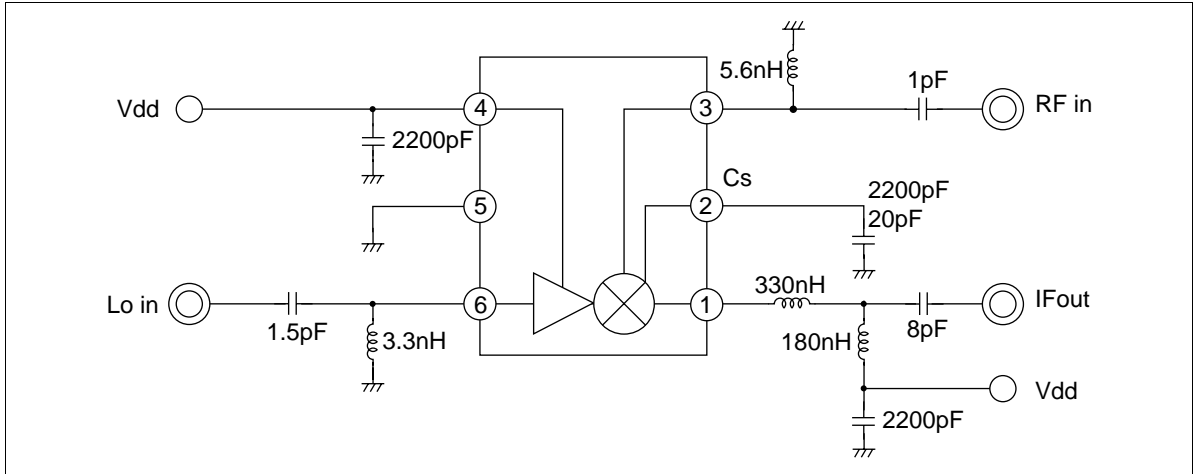

Main Characteristics

Output power,3rd Order Inter-modulation Distortion vs.Input power

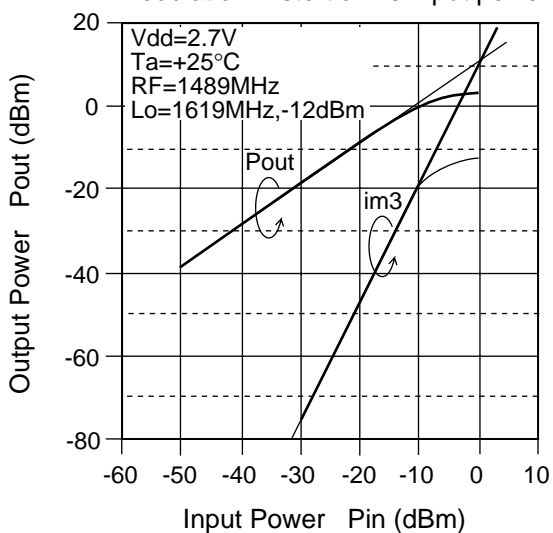

Current vs. Input Power

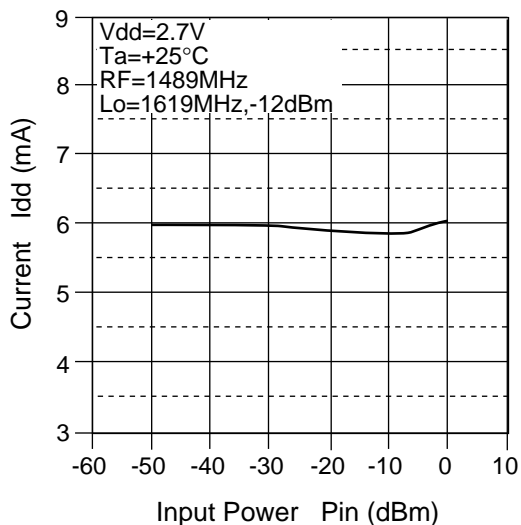

Conversion Gain,3rd Order intercept Point vs. Local Power

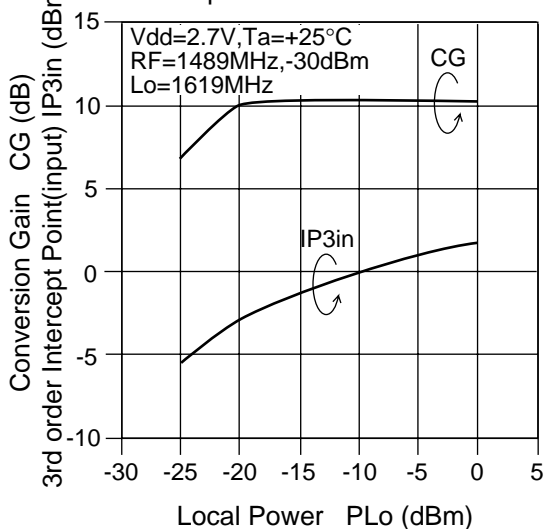

Noise Figure,Current vs. Local Power

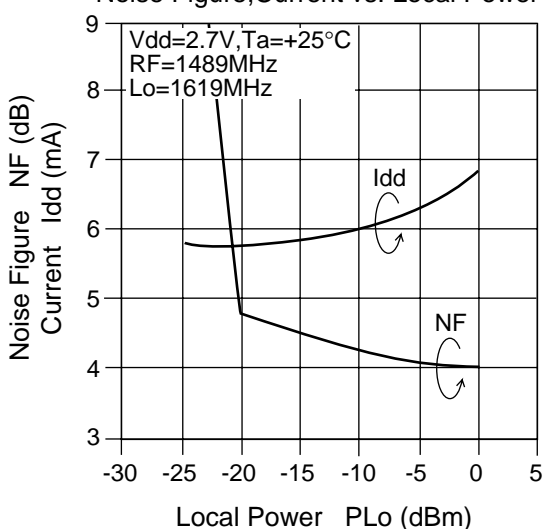

Conversion Gain, 3rd Order Intercept Point vs. Frequency

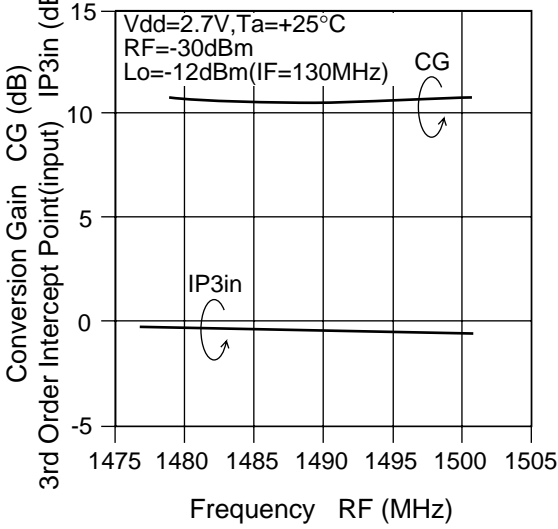

Noise Figure, Current vs. Frequency

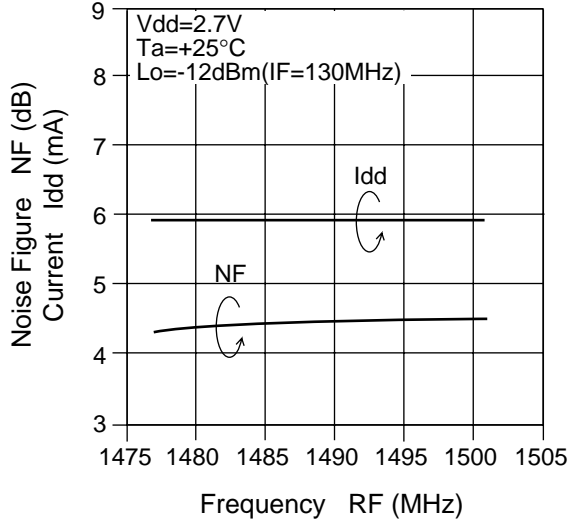

VSWR(RF) vs. Frequency

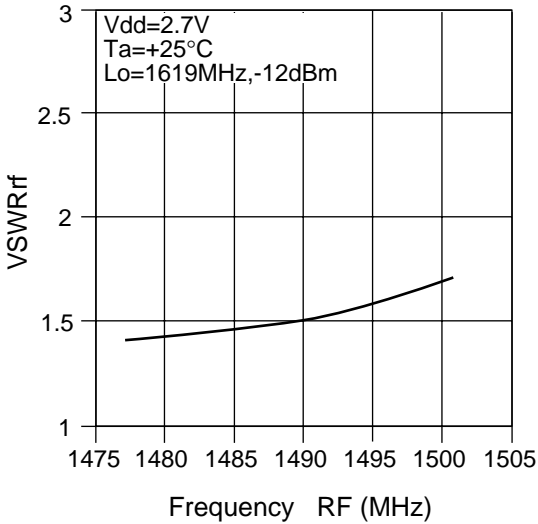

VSWR(Lo) vs. Frequency

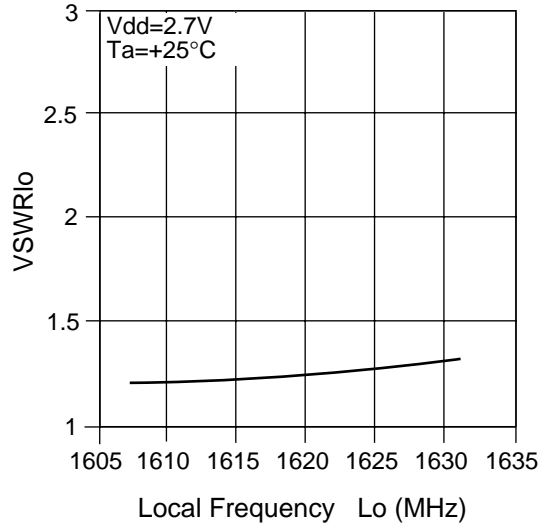

Conversion Gain, 3rd Order Intercept Point vs. Supply Voltage

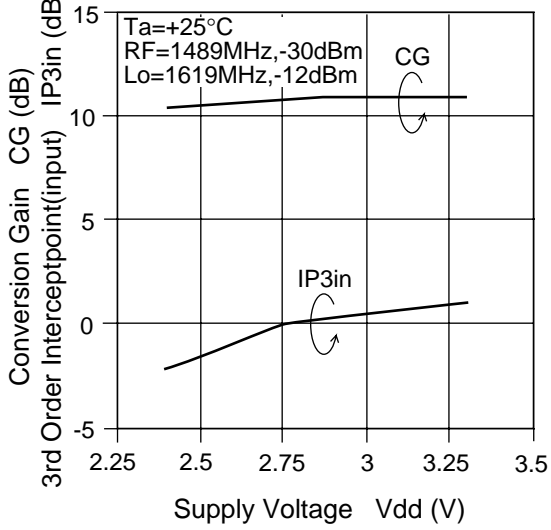

Noise Figure, Current vs. Supply Voltage

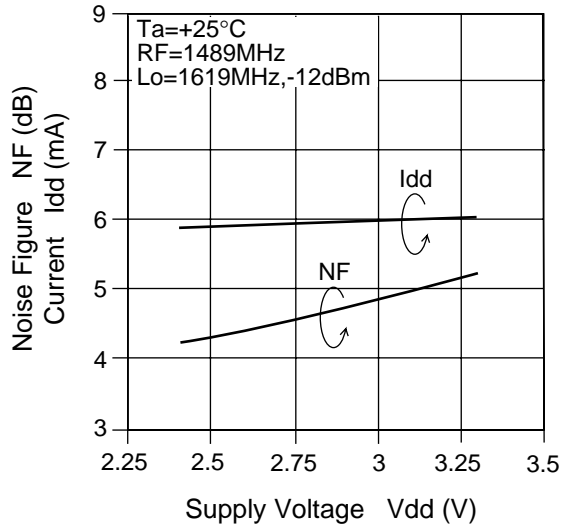

VSWR(RF) vs. Supply Voltage

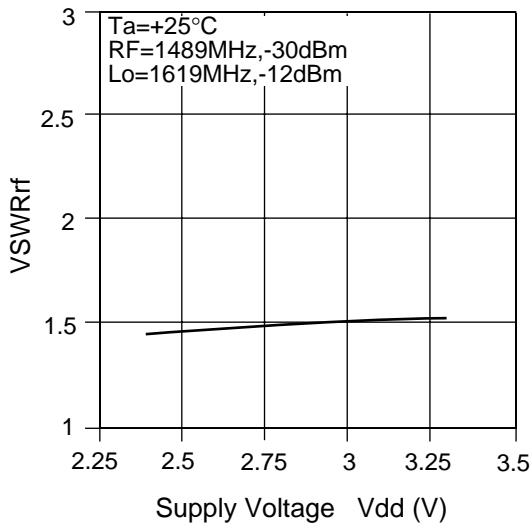

VSWR(Lo) vs. Supply Voltage

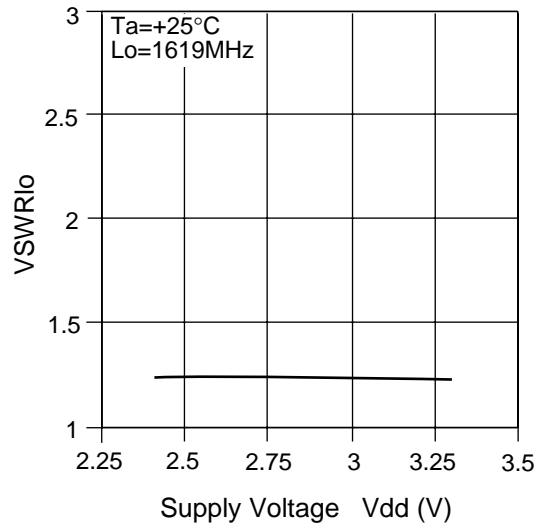

Conversion Gain, 3rd order Intercept Point vs. Ambient Temperature

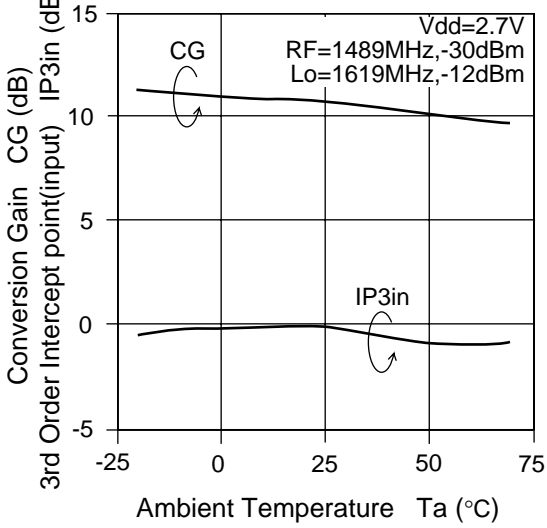

Noise Figure, Current vs. Ambient Temperature

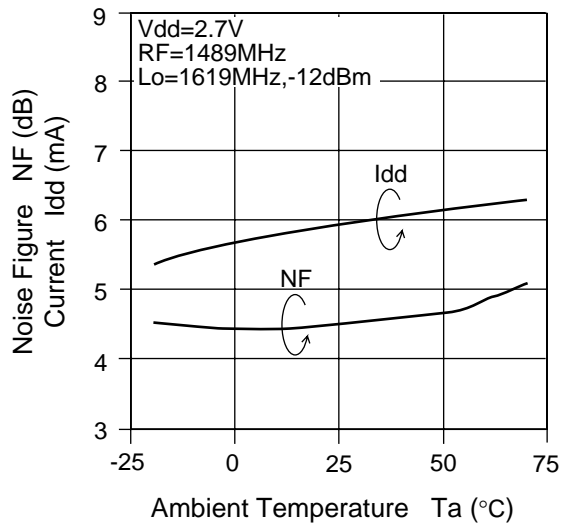

VSWR(RF) vs. Ambient Temperature

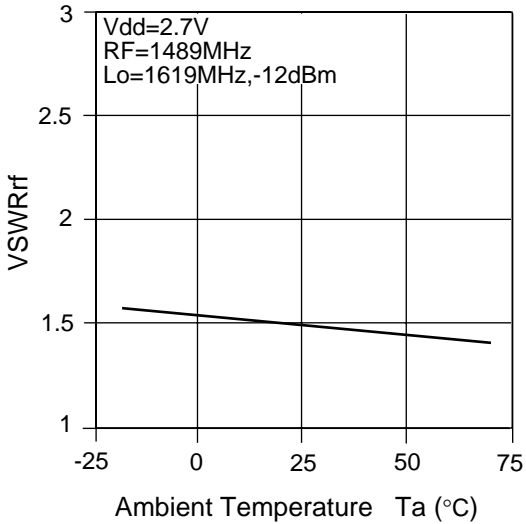

VSWR(Lo) vs. Ambient Temperature

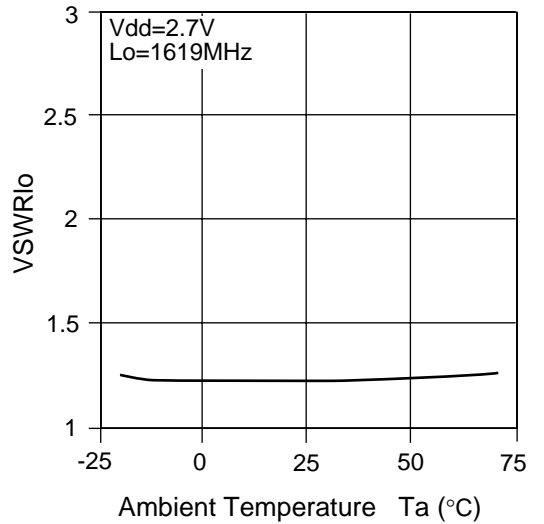

Package Dimintions

Unit: mm

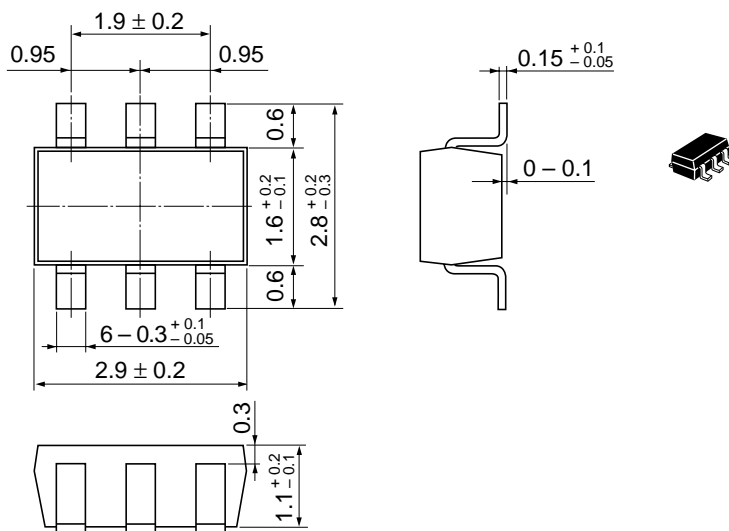

Hitachi Code	MPAK-6
JEDEC	—
EIAJ	—
Weight (reference value)	0.014 g

Cautions

1. Hitachi neither warrants nor grants licenses of any rights of Hitachi's or any third party's patent, copyright, trademark, or other intellectual property rights for information contained in this document. Hitachi bears no responsibility for problems that may arise with third party's rights, including intellectual property rights, in connection with use of the information contained in this document.
2. Products and product specifications may be subject to change without notice. Confirm that you have received the latest product standards or specifications before final design, purchase or use.
3. Hitachi makes every attempt to ensure that its products are of high quality and reliability. However, contact Hitachi's sales office before using the product in an application that demands especially high quality and reliability or where its failure or malfunction may directly threaten human life or cause risk of bodily injury, such as aerospace, aeronautics, nuclear power, combustion control, transportation, traffic, safety equipment or medical equipment for life support.
4. Design your application so that the product is used within the ranges guaranteed by Hitachi particularly for maximum rating, operating supply voltage range, heat radiation characteristics, installation conditions and other characteristics. Hitachi bears no responsibility for failure or damage when used beyond the guaranteed ranges. Even within the guaranteed ranges, consider normally foreseeable failure rates or failure modes in semiconductor devices and employ systemic measures such as fail-safes, so that the equipment incorporating Hitachi product does not cause bodily injury, fire or other consequential damage due to operation of the Hitachi product.
5. This product is not designed to be radiation resistant.
6. No one is permitted to reproduce or duplicate, in any form, the whole or part of this document without written approval from Hitachi.
7. Contact Hitachi's sales office for any questions regarding this document or Hitachi semiconductor products.

1. This product must not be placed in the mouth, as it contains toxic substances that may cause poisoning. If by chance the product is placed in the mouth, take emergency action such as inducing vomiting, then consult a physician without delay.
2. Disposal of this product must be handled, separately from other general refuse, by a specialist processing contractor in the same way as dangerous items.

HITACHI

Hitachi, Ltd.

Semiconductor & Integrated Circuits.

Nippon Bldg., 2-6-2, Ohte-machi, Chiyoda-ku, Tokyo 100-0004, Japan

Tel: Tokyo (03) 3270-2111 Fax: (03) 3270-5109

URL NorthAmerica : <http://semiconductor.hitachi.com/>
 Europe : <http://www.hitachi-eu.com/hel/ecg>
 Asia (Singapore) : <http://www.has.hitachi.com.sg/grp3/sicd/index.htm>
 Asia (Taiwan) : http://www.hitachi.com.tw/E/Product/SICD_Frame.htm
 Asia (HongKong) : <http://www.hitachi.com.hk/eng/bo/grp3/index.htm>
 Japan : <http://www.hitachi.co.jp/Sicd/indx.htm>

For further information write to:

Hitachi Semiconductor
 (America) Inc.
 179 East Tasman Drive,
 San Jose, CA 95134
 Tel: <1> (408) 433-1990
 Fax: <1> (408) 433-0223

Hitachi Europe GmbH
 Electronic components Group
 Dornacher StraÙe 3
 D-85622 Feldkirchen, Munich
 Germany
 Tel: <49> (89) 9 9180-0
 Fax: <49> (89) 9 29 30 00

Hitachi Europe Ltd.
 Electronic Components Group.
 Whitebrook Park
 Lower Cookham Road
 Maidenhead
 Berkshire SL6 8YA, United Kingdom
 Tel: <44> (1628) 585000
 Fax: <44> (1628) 778322

Hitachi Asia Pte. Ltd.
 16 Collyer Quay #20-00
 Hitachi Tower
 Singapore 049318
 Tel: 535-2100
 Fax: 535-1533

Hitachi Asia Ltd.
 Taipei Branch Office
 3F, Hung Kuo Building, No.167,
 Tun-Hwa North Road, Taipei (105)
 Tel: <886> (2) 2718-3666
 Fax: <886> (2) 2718-8180

Hitachi Asia (Hong Kong) Ltd.
 Group III (Electronic Components)
 7/F., North Tower, World Finance Centre,
 Harbour City, Canton Road, Tsim Sha Tsui,
 Kowloon, Hong Kong
 Tel: <852> (2) 735 9218
 Fax: <852> (2) 730 0281
 Telex: 40815 HITEC HX

Copyright ' Hitachi, Ltd., 1999. All rights reserved. Printed in Japan.