

**OBSOLETE PRODUCT**  
**No Recommended Replacement**  
 contact our Technical Support Center at  
 1-888-INTERSIL or [www.intersil.com/tsc](http://www.intersil.com/tsc)

**150MHz, High Slew Rate,  
 Precision Operational Amplifier**

The HA-2548 is an op amp that offers a unique combination of bandwidth, slew rate, and precision specifications. These features can eliminate the need for composite op amp designs and external calibration circuitry.

Optimized for gains  $\geq 5$ , the HA-2548 has a gain-bandwidth product of 150MHz and a slew rate of 120V/ $\mu$ s while maintaining extremely high open loop gain (130dB Typ) and low offset voltage (300 $\mu$ V Typ). These specifications are achieved through uniquely designed input circuitry and a single ultra-high gain stage that minimizes the AC signal path. Capable of delivering over 30mA of output current, the HA-2548 is ideal for precision, high speed applications such as signal conditioning, instrumentation, video/pulse amplifiers and buffers.

For information on the military version of this device please refer to the HA-2548/883 datasheet.

**Features**

- High Slew Rate . . . . . 120V/ $\mu$ s
- Low Offset Voltage . . . . . 300 $\mu$ V
- High Open Loop Gain . . . . . 130dB
- Gain Bandwidth Product . . . . . 150MHz
- Low Noise Voltage at 1kHz . . . . . 8.3nV/ $\sqrt{\text{Hz}}$
- Minimum Gain Stability . . . . .  $\geq 5$

**Applications**

- High Speed Instrumentation
- Data Acquisition Systems
- Analog Signal Conditioning
- Precision, Wideband Amplifiers
  - Pulse/RF Amplifiers

**Part Number Information**

PART NUMBER	TEMP. RANGE (°C)	PACKAGE	PKG. NO.
HA2-2548-5	0 to 75	8 Pin Metal Can	T8.C
HA2-2548-9	-40 to 85	8 Pin Metal Can	T8.C
HA3-2548-5	0 to 75	8 Ld PDIP	E8.3
HA7-2548-5	0 to 75	8 Ld SBDIP	D8.3
HA9P2548-5	0 to 75	16 Ld SOIC	M16.3

**Pinouts**

**HA-2548  
 (PDIP, SBDIP)  
 TOP VIEW**

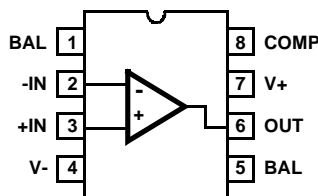

**HA-2548  
 (METAL CAN)  
 TOP VIEW**

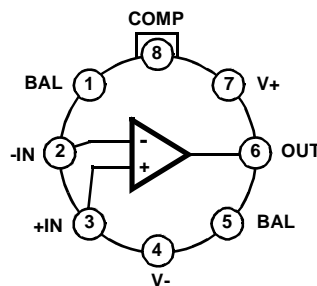

**HA-2548  
 (SOIC)  
 TOP VIEW**

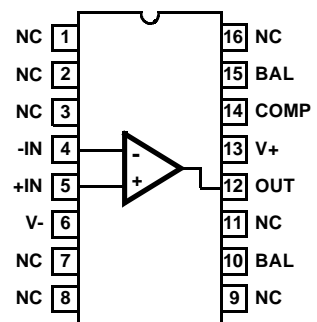

# HA-2548

## Absolute Maximum Ratings

Supply Voltage Between V+ and V- Terminals	.40V
Differential Input Voltage	.5V
Output Current	40mA

## Operating Conditions

Temperature Range	
HA-2548-5	0°C to 75°C
HA-2548-9	-40°C to 85°C

## Thermal Information

Thermal Resistance (Typical, Note 1)	$\theta_{JA}$ (°C/W)	$\theta_{JC}$ (°C/W)
SBDIP Package	110	30
PDIP Package	92	N/A
SOIC Package	96	N/A
Metal Can Package	165	80
Maximum Junction Temperature (Hermetic Packages)	175°C	
Maximum Junction Temperature (Plastic Package)	150°C	
Maximum Storage Temperature Range	-65°C to 150°C	
Maximum Lead Temperature (Soldering 10s)	300°C (SOIC - Lead Tips Only)	

CAUTION: Stresses above those listed in "Absolute Maximum Ratings" may cause permanent damage to the device. This is a stress only rating and operation of the device at these or any other conditions above those indicated in the operational sections of this specification is not implied.

## NOTE:

- $\theta_{JA}$  is measured with the component mounted on an evaluation PC board in free air.

## Electrical Specifications $V_{SUPPLY} = \pm 15V$ , $R_L = 1k\Omega$ , $C_L = 10pF$ , Unless Otherwise Specified

PARAMETER	TEST CONDITIONS	TEMP (°C)	HA-2548-5, -9			UNITS
			MIN	TYP	MAX	
<b>INPUT CHARACTERISTICS</b>						
Input Offset Voltage		25	-	300	900	$\mu V$
		Full	-	400	1200	$\mu V$
Average Offset Voltage Drift (Note 5)		Full	-	4	9	$\mu V/^\circ C$
Input Bias Current		25	-	5	50	nA
		Full	-	20	100	nA
Input Offset Current		25	-	5	50	nA
		Full	-	20	100	nA
Common Mode Range		25	$\pm 7$	$\pm 10$	-	V
Differential Input Resistance		25	-	1	-	M $\Omega$
Input Noise Voltage	f = 0.1Hz to 10Hz	25	-	0.2	-	$\mu V_{RMS}$
	f = 0.1Hz to 1MHz	25	-	0.8	-	$\mu V_{RMS}$
Input Noise Voltage Density (Note 2)	f = 10Hz	25	-	30	-	$nV/\sqrt{Hz}$
	f = 100Hz	25	-	12	-	$nV/\sqrt{Hz}$
	f = 1000Hz	25	-	8.3	-	$nV/\sqrt{Hz}$
Input Noise Current Density (Note 2)	f = 10Hz	25	-	1.9	-	$pA/\sqrt{Hz}$
	f = 100Hz	25	-	0.7	-	$pA/\sqrt{Hz}$
	f = 1000Hz	25	-	0.4	-	$pA/\sqrt{Hz}$
<b>TRANSFER CHARACTERISTICS</b>						
Large Signal Voltage Gain	$V_{OUT} = \pm 10V$	25	114	130	-	dB
		Full	108	125	-	dB
Common Mode Rejection Ratio	$V_{CM} = \pm 2V$	Full	80	90	-	dB
Gain Bandwidth Product (Note 5)	$A_V = -100$ , f = 100kHz to 10MHz	25	130	150	-	MHz
		Full	110	125	-	MHz
Minimum Stable Gain		Full	5	-	-	V/V
<b>OUTPUT CHARACTERISTICS</b>						
Output Voltage Swing		Full	$\pm 11$	$\pm 12$	-	V
Output Current	$R_L = 1k\Omega$ , $V_{OUT} \geq 10V$	Full	$\pm 30$	$\pm 33$	-	mA
Output Resistance		25	-	5	-	$\Omega$
Full Power Bandwidth (Note 3)		25	-	1.91	-	MHz
<b>TRANSIENT RESPONSE</b> $A_V = +5$ , Unless Otherwise Specified						

**Electrical Specifications**  $V_{SUPPLY} = \pm 15V$ ,  $R_L = 1k\Omega$ ,  $C_L = 10pF$ , Unless Otherwise Specified (Continued)

PARAMETER	TEST CONDITIONS	TEMP (°C)	HA-2548-5, -9			UNITS
			MIN	TYP	MAX	
Slew Rate (Note 5) Positive	$V_{OUT} = \pm 5V$	25	80	120	-	V/ $\mu s$
		Full	70	105	-	V/ $\mu s$
Slew Rate (Note 5) Negative	$V_{OUT} = \pm 5V$	25	70	110	-	V/ $\mu s$
		Full	60	105	-	V/ $\mu s$
Rise Time (Note 5)	$V_{OUT} = \pm 100mV$	25	-	16.5	20	ns
		Full	-	19	23	ns
Fall Time (Note 5)	$V_{OUT} = \pm 100mV$	25	-	16	20	ns
		Full	-	18	23	ns
Overshoot (Note 5) Positive	$V_{OUT} = \pm 100mV$	25	-	15	25	%
		Full	-	25	35	%
Overshoot (Note 5) Negative	$V_{OUT} = \pm 100mV$	25	-	8	15	%
		Full	-	20	30	%
Settling Time	Notes 4, 5	25	-	200	260	ns
<b>POWER SUPPLY</b>						
Power Supply Rejection Ratio	$V_S = \pm 10V$ to $\pm 20V$	Full	86	95	-	dB
$I_{CC}$		Full	-	12	18	mA

NOTES:

- Refer to typical performance curve in data sheet.
- Full Power Bandwidth is calculated by:  $FPBW = \frac{\text{Slew Rate}}{2\pi V_{PEAK}}$ ,  $V_{PEAK} = 10V$ .
- Settling time is specified to 0.01% with a 10V step and  $A_V = -5$ .
- These parameters are not tested. The limits are guaranteed based on lab characterization and reflect lot to lot variation.

**Test Circuits and Waveforms**

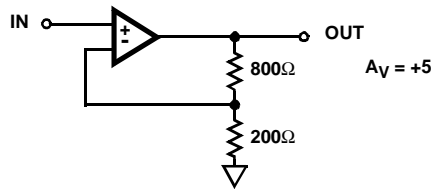
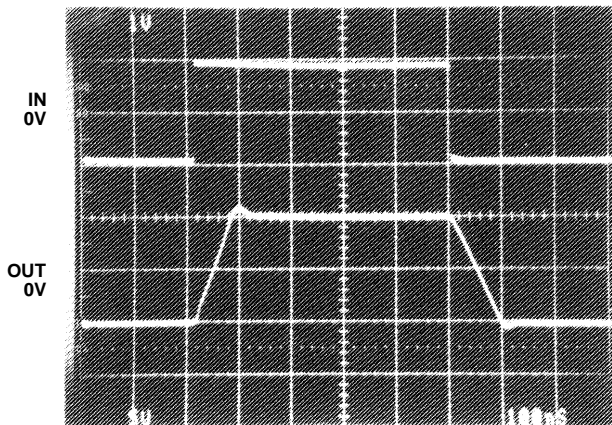
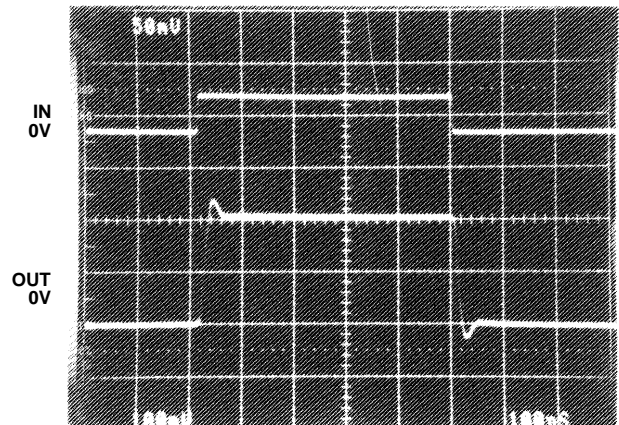

FIGURE 1. LARGE AND SMALL SIGNAL RESPONSE CIRCUIT



$V_{OUT} = \pm 5V$ ,  $A_V = +5$ ,  $R_L = 1K$ ,  $C_L \leq 10pF$

FIGURE 2. LARGE SIGNAL RESPONSE



$V_{OUT} = \pm 100mV$ ,  $A_V = +5$ ,  $R_L = 1K$ ,  $C_L \leq 10pF$

FIGURE 3. SMALL SIGNAL RESPONSE

Test Circuits and Waveforms (Continued)

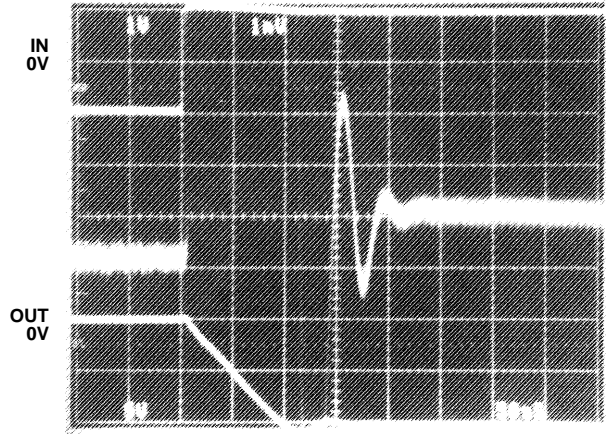
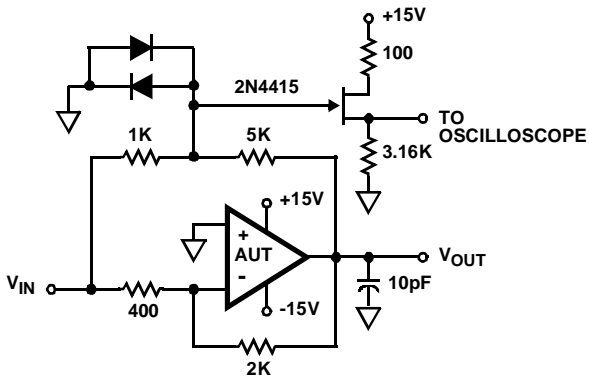

NOTES:

6.  $A_v = -5$ .
7. Feedback and summing resistors should be 0.1% matched.
8. Clipping diodes are optional. HP5082-2810 recommended.

$A_v = -5$ , Output = -10V Output Scale Vertical: 1mV/Div., Horizontal: 50ns/Div.

FIGURE 4. SETTLING TIME TEST CIRCUIT

FIGURE 5. HA-2548 SETTLING TIME

Schematic Diagram

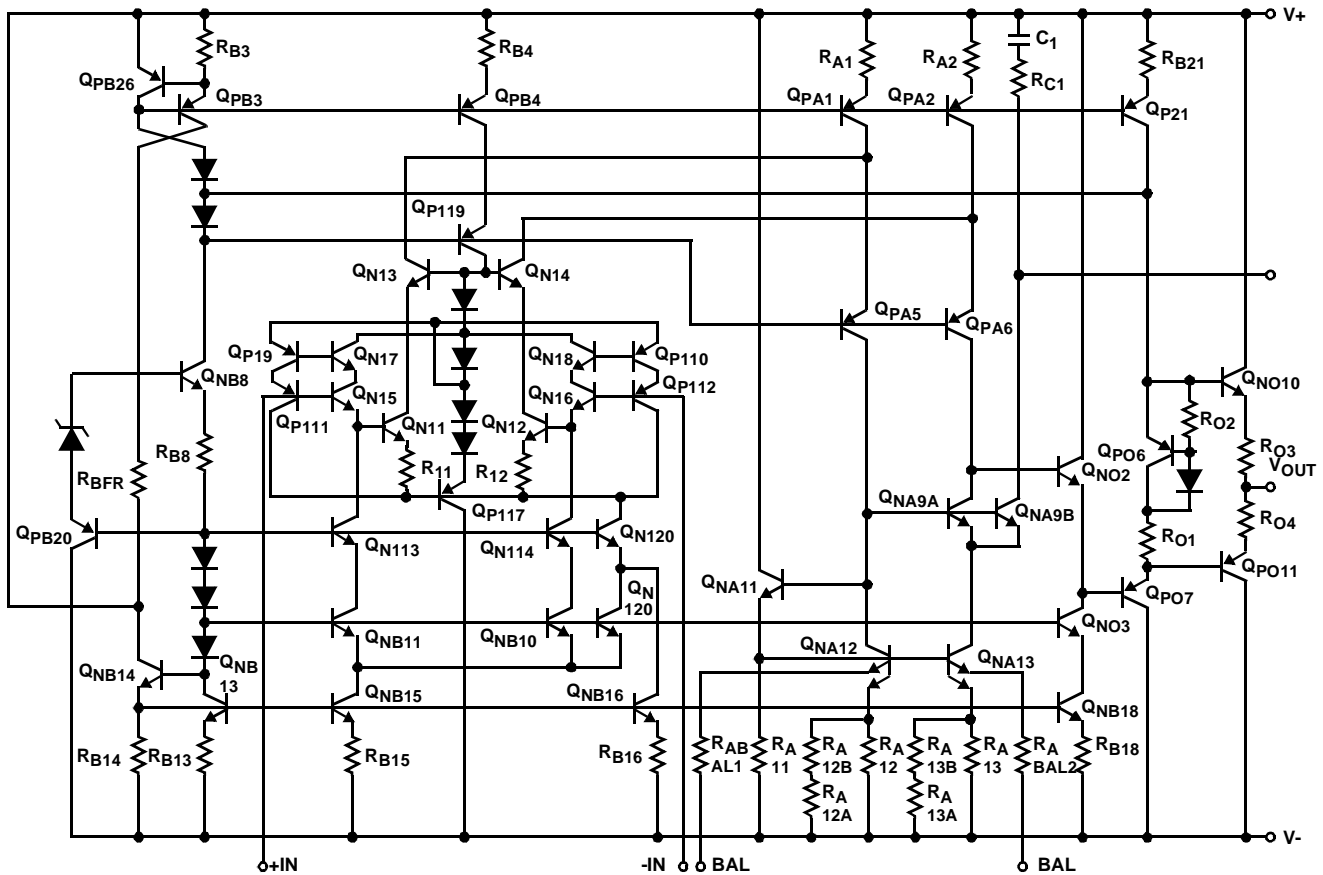

Application Information

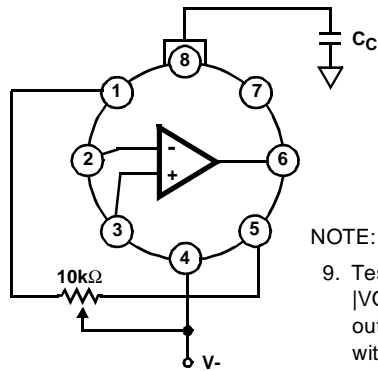

NOTE:

9. Tested Offset Adjustment Range is  $|V_{OS} + 1mV|$  minimum referred to output. Typical range is  $\pm 20mV$  with  $R_T = 10k\Omega$ .

FIGURE 6. SUGGESTED VOS ADJUSTMENT AND COMPENSATION HOOK UP

Typical Performance Curves  $V_S = \pm 15V, T_A = 25^\circ C$

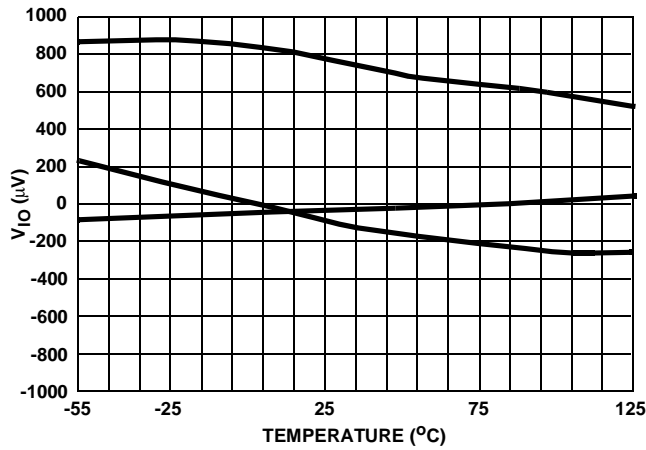

FIGURE 7.  $V_{IO}$  vs TEMPERATURE (3 REPRESENTATIVE UNITS)

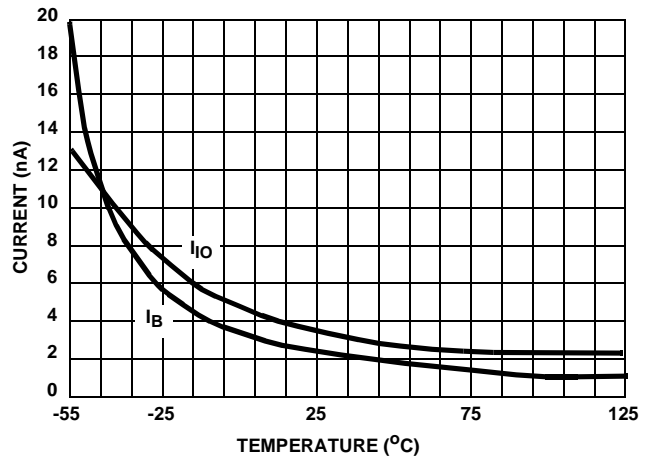

FIGURE 8. OFFSET CURRENT/BIAS CURRENT vs TEMPERATURE

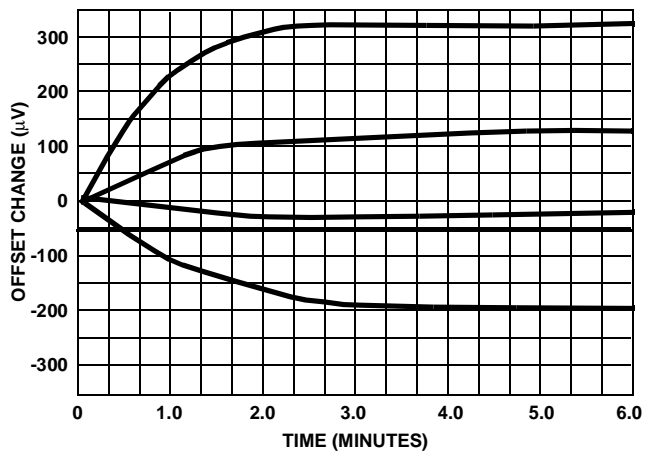

FIGURE 9.  $V_{IO}$  WARM-UP DRIFT (NORMALIZED FROM ZERO) (4 REPRESENTATIVE UNITS)

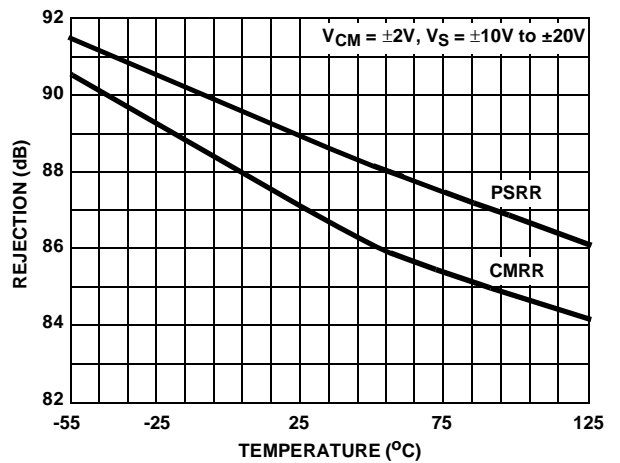

FIGURE 10. PSRR/CMRR vs TEMPERATURE

Typical Performance Curves  $V_S = \pm 15V, T_A = 25^\circ C$  (Continued)

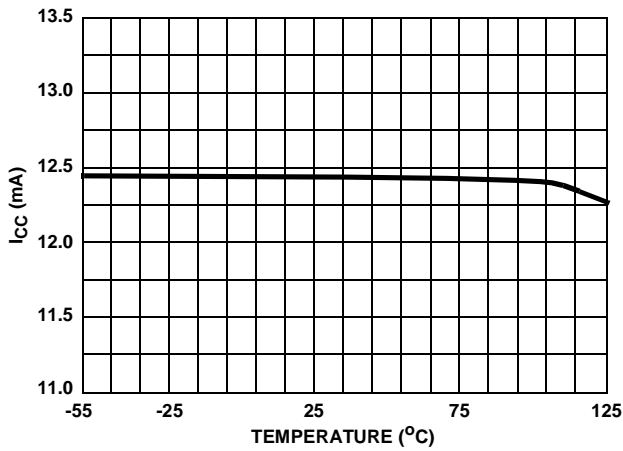

FIGURE 11.  $I_{CC}$  vs TEMPERATURE

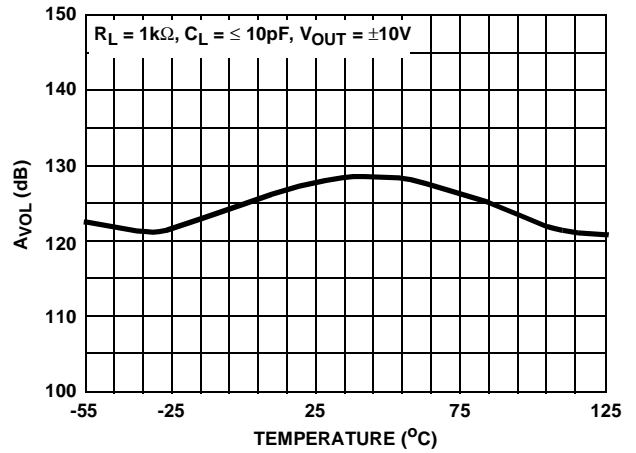

FIGURE 12.  $A_{VOL}$  vs TEMPERATURE

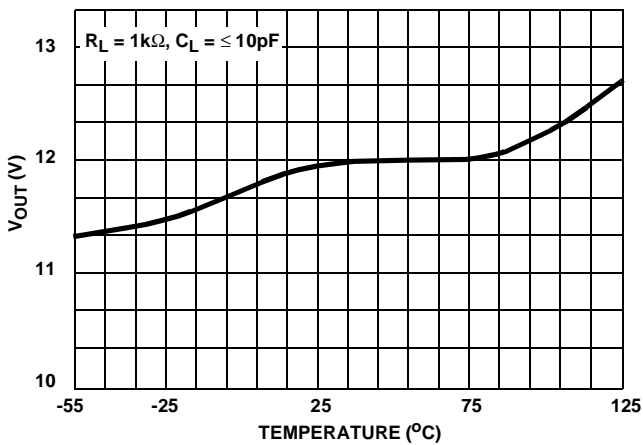

FIGURE 13.  $V_{OUT}$  vs TEMPERATURE

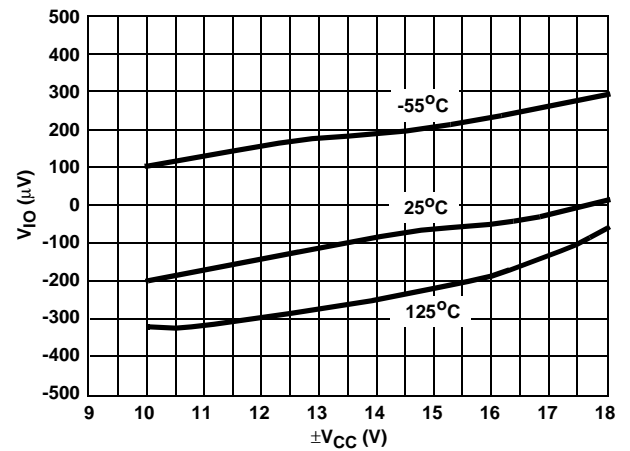

FIGURE 14.  $V_{IO}$  vs  $\pm V_{CC}$  vs TEMPERATURE

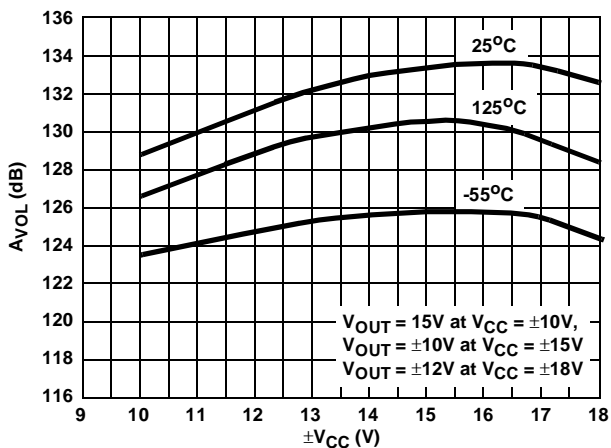

FIGURE 15.  $A_{VOL}$  vs  $\pm V_{CC}$  vs TEMPERATURE

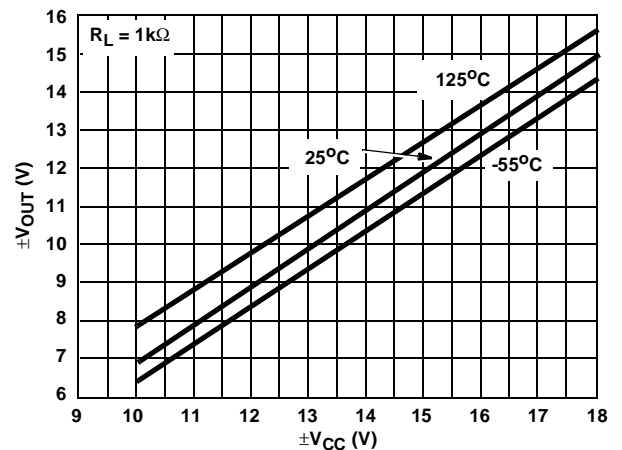

FIGURE 16.  $\pm V_{OUT}$  vs  $\pm V_{CC}$  vs TEMPERATURE

**Typical Performance Curves**  $V_S = \pm 15V, T_A = 25^\circ C$  (Continued)

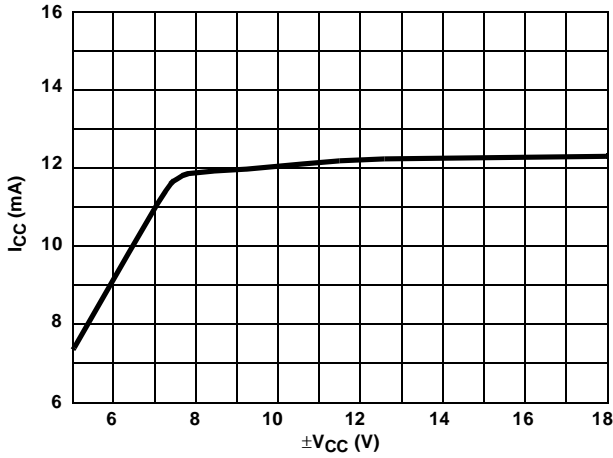

FIGURE 17. SUPPLY CURRENT vs SUPPLY VOLTAGE

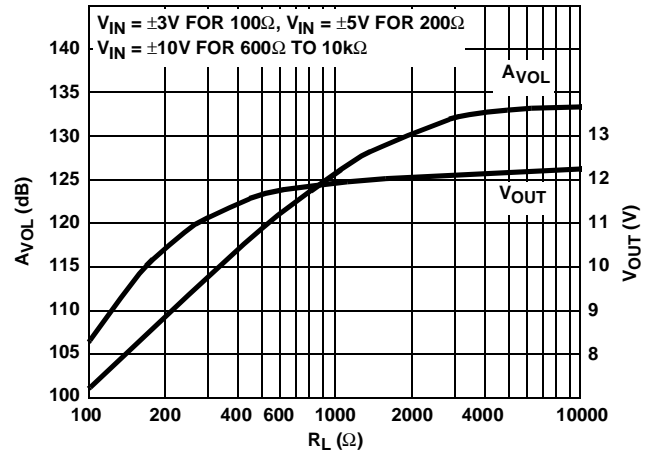

FIGURE 18.  $A_{VOL}/V_{OUT}$  vs  $R_L$

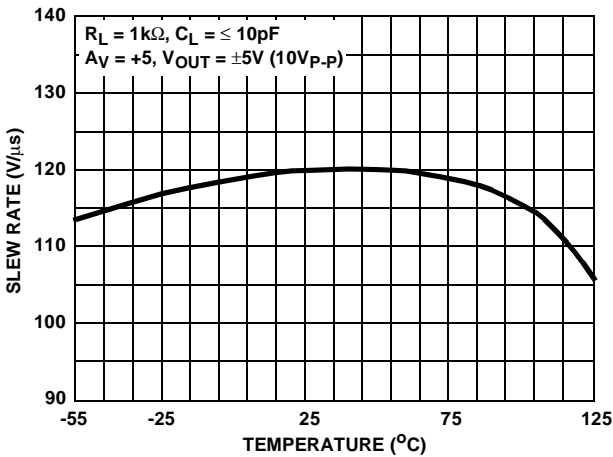

FIGURE 19. SLEW RATE vs TEMPERATURE

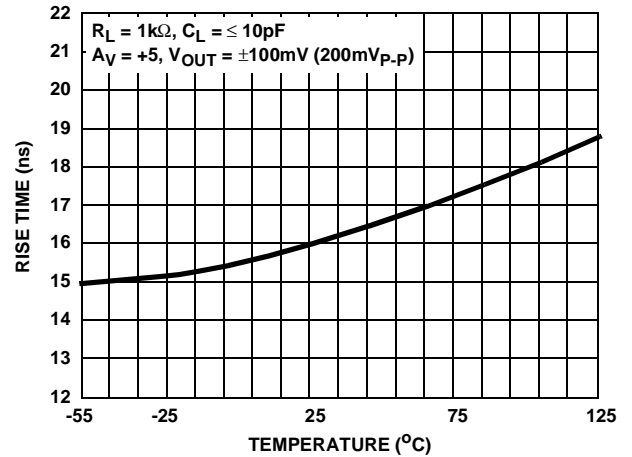

FIGURE 20. RISE TIME vs TEMPERATURE

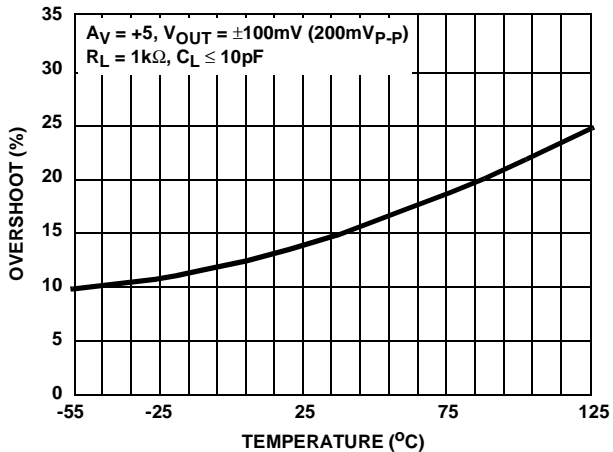

FIGURE 21. OVERSHOOT vs TEMPERATURE

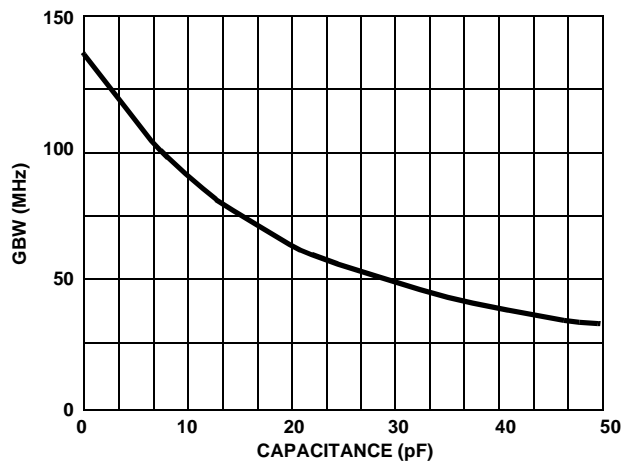

FIGURE 22. GAIN BANDWIDTH PRODUCT vs COMPENSATION CAPACITANCE TO GND



**Typical Performance Curves**  $V_S = \pm 15V, T_A = 25^\circ C$  (Continued)

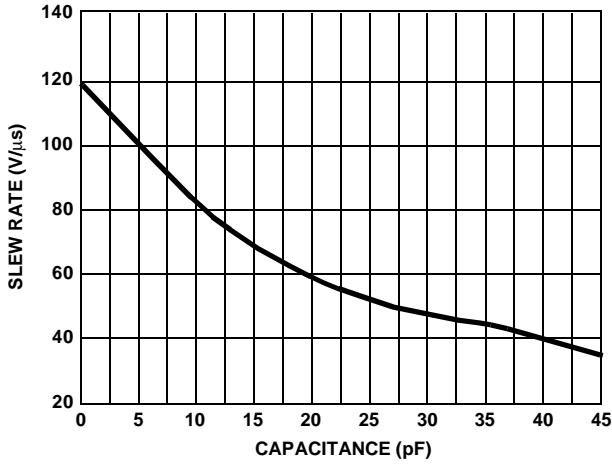

FIGURE 23. SLEW RATE vs COMPENSATION CAPACITANCE TO GND

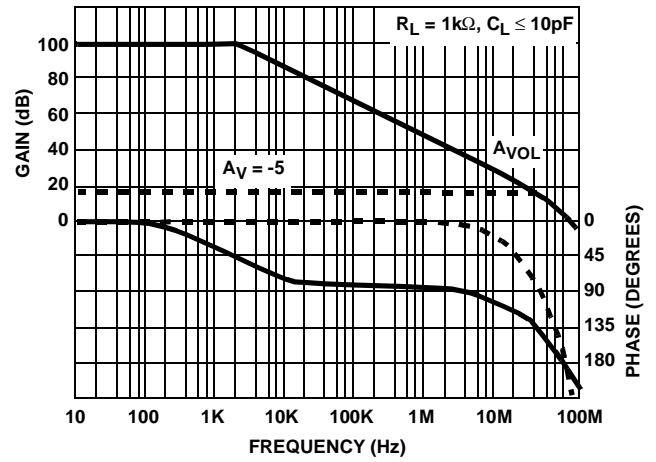

FIGURE 24. GAIN AND PHASE vs FREQUENCY

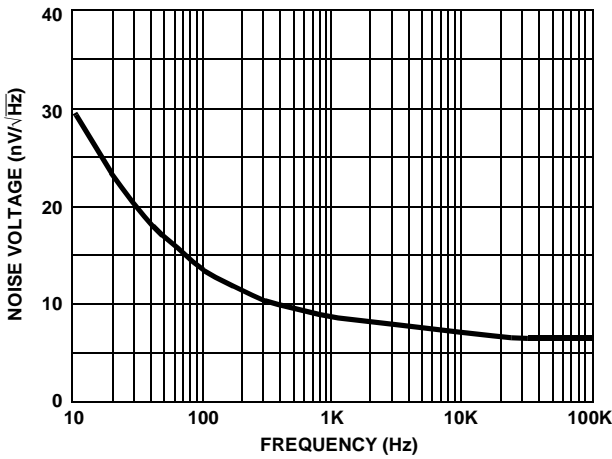

FIGURE 25. INPUT NOISE VOLTAGE DENSITY

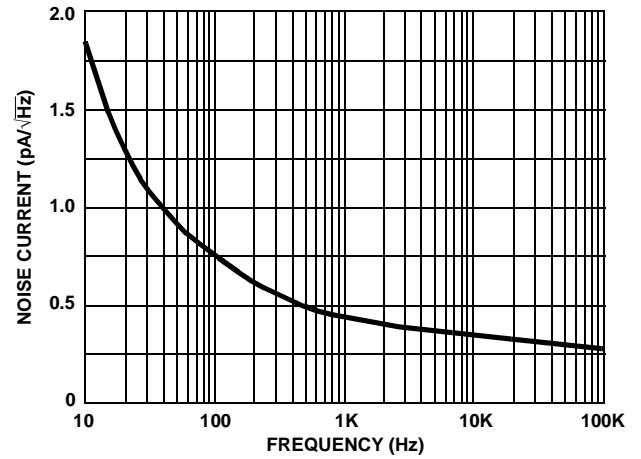
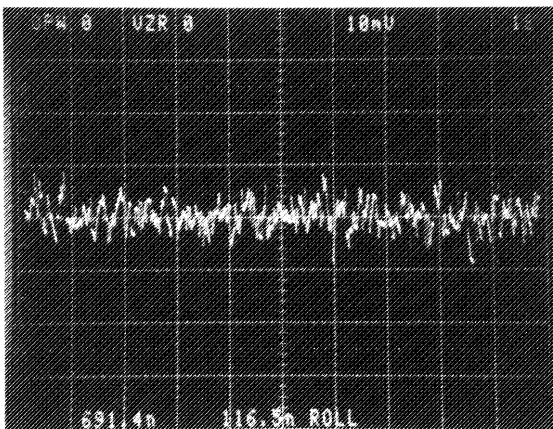
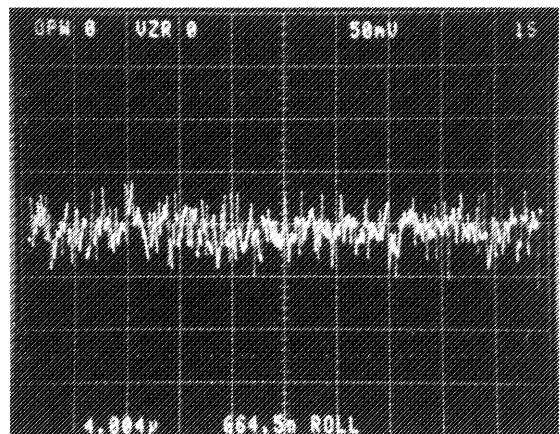

FIGURE 26. INPUT NOISE CURRENT DENSITY



P-P(RTI) = 691.4nV, RMS(RTI) = 116.5nV,  $A_V = 25000$

FIGURE 27. PEAK TO PEAK NOISE 0.1Hz TO 10Hz



P-P(RTI) = 4.004 $\mu$ V, RMS(RTI) = 664.5nV,  $A_V = 25000$

FIGURE 28. PEAK TO PEAK NOISE 0.1Hz TO 1MHz



**Typical Performance Curves**  $V_S = \pm 15V, T_A = 25^\circ C$  (Continued)

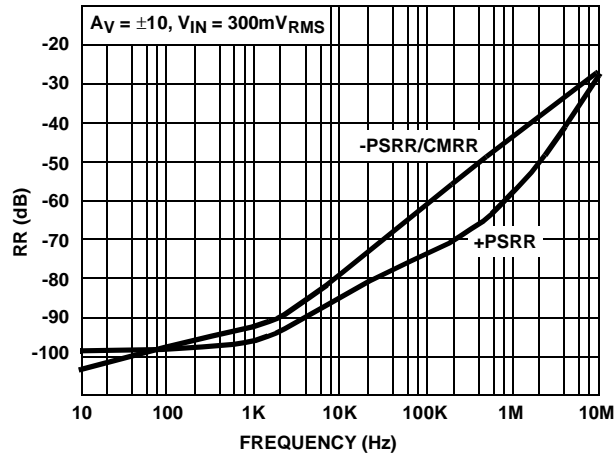

FIGURE 29. REJECTION RATIOS vs FREQUENCY

**Die Characteristics**

**DIE DIMENSIONS:**

85 mils x 91 mils x 19 mils  
 2160 $\mu m$  x 2320 $\mu m$  x 483 $\mu m$

**METALLIZATION:**

Type: Aluminum, 1% Copper  
 Thickness: 16k $\text{\AA}$   $\pm$  2k $\text{\AA}$

**SUBSTRATE POTENTIAL**

V-

NOTE: The substrate may be left floating (Insulating Die Mount) or it may be mounted on conductor at V- potential.

**PASSIVATION:**

Type: Nitride over Silox  
 Silox Thickness: 12k $\text{\AA}$   $\pm$  2k $\text{\AA}$   
 Nitride Thickness: 3.5k $\text{\AA}$   $\pm$  1k $\text{\AA}$

**TRANSISTOR COUNT:**

60

**Metallization Mask Layout**

