

**OBSOLETE PRODUCT**  
HA-5101: See HA-5127A, HA-5221  
HA-5111: See HA-5147A, HA-5221

September 1998

File Number 2905.3

**10MHz and 100MHz, Low Noise, Operational Amplifiers**

The HA-5101/5111 are dielectrically isolated operational amplifiers featuring low noise. Both amplifiers have an excellent noise voltage density of  $3.0nV/\sqrt{Hz}$  at 1kHz. The uncompensated HA-5111 is stable at a minimum gain of 10 and has the same DC specifications as the unity gain stable HA-5101. The difference in compensation yields a 100MHz gain-bandwidth product and a  $50V/\mu s$  slew rate for the HA-5111 versus a 10MHz unity gain bandwidth and a  $10V/\mu s$  slew rate for the HA-5101.

DC characteristics of the HA-5101/5111 assure accurate performance. The 0.5mV offset voltage is externally adjustable and offset voltage drift is just  $3\mu V/^\circ C$ . An offset current of only 30nA reduces input current errors and an open loop voltage gain of  $1 \times 10^6 V/V$  increases loop gain for low distortion amplification.

The HA-5101/5111 are ideal for audio applications, especially low-level signal amplifiers such as microphone, tape head and phono cartridge preamplifiers. Additionally, it is well suited for low distortion oscillators, low noise function generators and high Q filters.

**Pinouts**

HA-5101, HA-5111 (PDIP, CERDIP, SOIC)  
TOP VIEW

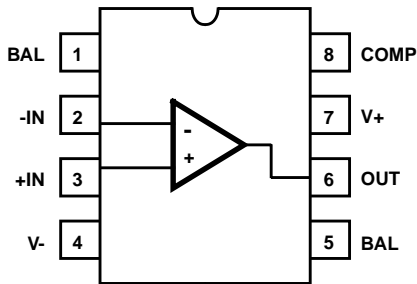

HA-5101 (CAN)  
TOP VIEW

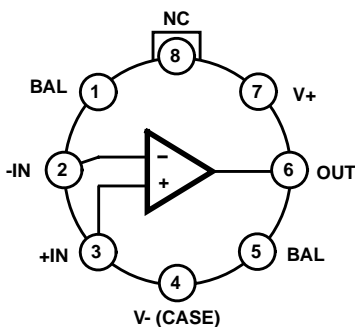

**Features**

- Low Noise . . . . .  $3.0nV/\sqrt{Hz}$  at 1kHz
- Bandwidth . . . . . 10MHz (Compensated)  
100MHz (Uncompensated)
- Slew Rate . . . . .  $10V/\mu s$  (Compensated)  
 $50V/\mu s$  (Uncompensated)
- Low Offset Voltage Drift . . . . .  $3\mu V/^\circ C$
- High Gain . . . . .  $1 \times 10^6 V/V$
- High CMRR/PSRR . . . . . 100dB
- High Output Drive Capability . . . . . 30mA

**Applications**

- High Quality Audio Preamplifiers
- High Q Active Filters
- Low Noise Function Generators
- Low Distortion Oscillators
- Low Noise Comparators
- For Further Design Ideas, See Application Note AN554, Harris AnswerFAX (407-724-7800) Document #9554

**Part Number Information**

PART NUMBER (BRAND)	TEMP. RANGE ( $^\circ C$ )	PACKAGE	PKG. NO.
HA2-5101-2	-55 to 125	8 Pin Can	T8.C
HA3-5101-5	0 to 75	8 Ld PDIP	E8.3
HA7-5101-2	-55 to 125	8 Ld CERDIP	F8.3A
HA9P5101-5 (H51015)	0 to 75	8 Ld SOIC	M8.15
HA9P5101-9 (H51019)	-40 to 85	8 Ld SOIC	M8.15
HA3-5111-5	0 to 75	8 Ld PDIP	E8.3
HA7-5111-2	-55 to 125	8 Ld CERDIP	F8.3A
HA9P5111-5 (H51115)	0 to 75	8 Ld SOIC	M8.15
HA9P5111-9 (H51119)	-40 to 85	8 Ld SOIC	M8.15

Schematic

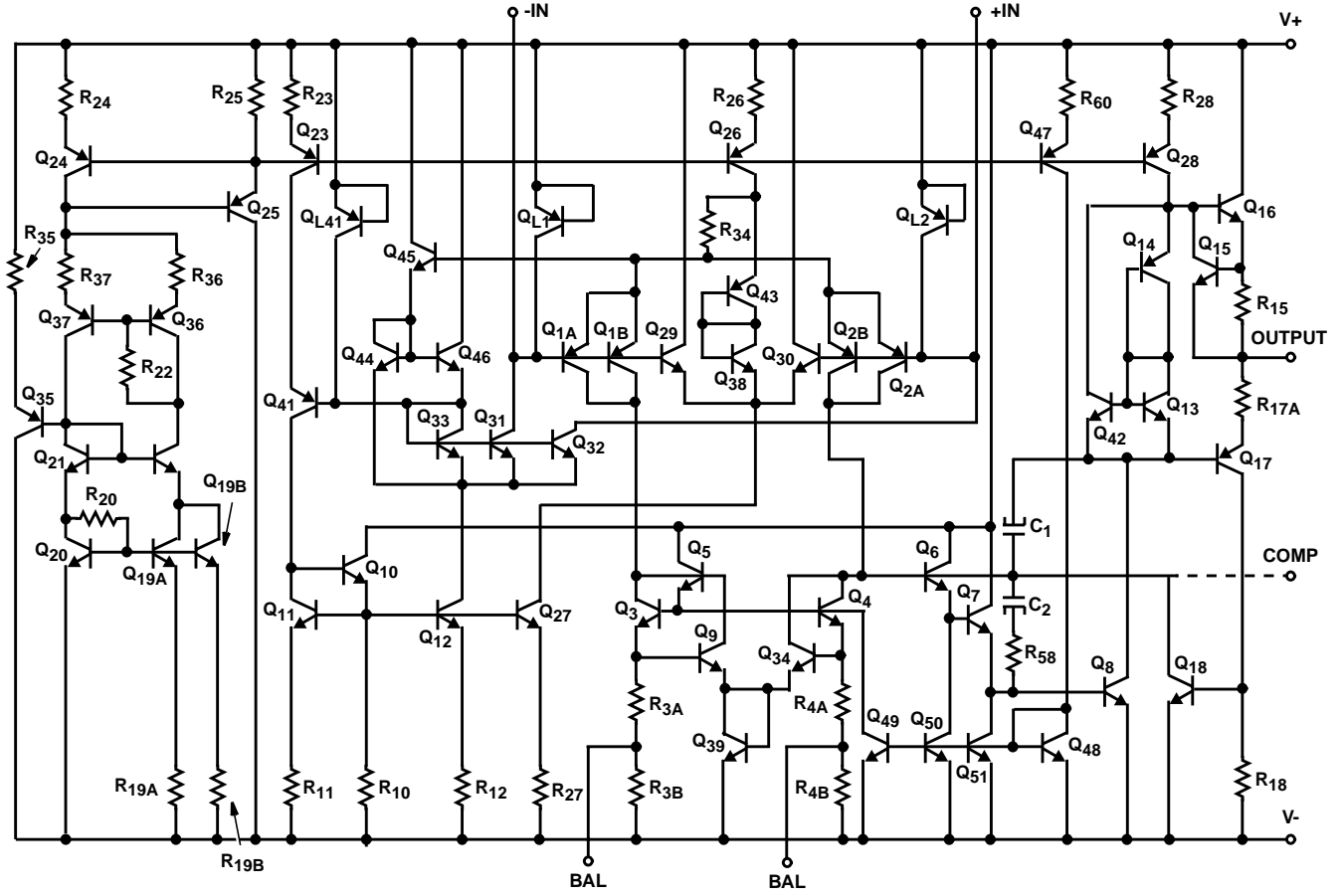

# HA-5101, HA-5111

## Absolute Maximum Ratings

Voltage Between V+ and V- Terminals	40V
Differential Input Voltage	7V
Input Voltage	$\pm V_{SUPPLY}$
Output Current	Full Short Circuit Protection

## Operating Conditions

Temperature Range	
HA-5101/5111-2	-55°C to 125°C
HA-5101/5111-5	0°C to 75°C
HA-5101/5111-9	-40°C to 85°C

## Thermal Information

Thermal Resistance (Typical, Note 2)	$\theta_{JA}$ (°C/W)	$\theta_{JC}$ (°C/W)
Can Package	165	80
PDIP Package	94	N/A
CERDIP Package	135	50
SOIC Package	157	N/A
Maximum Junction Temperature (Note 1)	175°C	
Maximum Junction Temperature (Plastic Package)	150°C	
Maximum Storage Temperature Range	-65°C to 150°C	
Maximum Lead Temperature (Soldering 10s)	300°C (SOIC - Lead Tips Only)	

*CAUTION: Stresses above those listed in "Absolute Maximum Ratings" may cause permanent damage to the device. This is a stress only rating and operation of the device at these or any other conditions above those indicated in the operational sections of this specification is not implied.*

## NOTES:

- Maximum power dissipation, including output load, must be designed to maintain the maximum junction temperature below 175°C for hermetic packages, and below 150°C for the plastic packages.
- $\theta_{JA}$  is measured with the component mounted on an evaluation PC board in free air.

## Electrical Specifications $V_{SUPPLY} = \pm 15V, R_S = 100\Omega, R_L = 2k\Omega, C_L = 50pF$ , Unless Otherwise Specified

PARAMETER	TEST CONDITIONS	TEMP (°C)	HA-5101-2, -5; HA-5111-2, -5			HA-5101-9, HA-5111-9			UNITS
			MIN	TYP	MAX	MIN	TYP	MAX	
<b>INPUT CHARACTERISTICS</b>									
Offset Voltage		25	-	0.5	3	-	0.5	3	mV
		Full	-	-	4	-	-	4	mV
Offset Voltage Drift		Full	-	3	-	-	3	-	$\mu V/^\circ C$
Bias Current		25	-	100	200	-	100	200	nA
		Full	-	-	325	-	-	325	nA
Offset Current		25	-	30	75	-	30	75	nA
		Full	-	-	125	-	-	125	nA
Input Resistance		25	-	500	-	-	500	-	k $\Omega$
Common Mode Range		Full	$\pm 12$	-	-	$\pm 12$	-	-	V
<b>TRANSFER CHARACTERISTICS</b>									
Large Signal Voltage Gain	$V_{OUT} = \pm 10V$	25	-	1000	-	-	1000	-	kV/V
		Full	100	250	-	100	250	-	kV/V
Common Mode Rejection Ratio	$V_{CM} = \pm 10V$	Full	80	100	-	80	100	-	dB
Small Signal Bandwidth	HA-5101, $A_V = 1$	25	-	10	-	-	10	-	MHz
Gain Bandwidth Product	HA-5111, $A_V = 10$	25	-	100	-	-	100	-	MHz
Minimum Stable Gain	HA-5101	Full	1	-	-	1	-	-	V/V
	HA-5111	Full	10	-	-	10	-	-	V/V
<b>OUTPUT CHARACTERISTICS</b>									
Output Voltage Swing	$R_L = 10k\Omega$	Full	$\pm 12$	$\pm 13$	-	$\pm 12$	$\pm 13$	-	V
	$R_L = 2k\Omega$	Full	$\pm 12$	$\pm 13$	-	$\pm 12$	$\pm 13$	-	V
	$V_S = \pm 18V, R_L = 600\Omega$	25	$\pm 15$	-	-	$\pm 15$	-	-	V
Output Current (Note 3)		25	25	30	-	25	30	-	mA
Full Power Bandwidth (Note 4)	HA-5101	25	95	160	-	95	160	-	kHz
	HA-5111	25	630	790	-	630	790	-	kHz
Output Resistance		25	-	110	-	-	110	-	$\Omega$

# HA-5101, HA-5111

## Electrical Specifications $V_{SUPPLY} = \pm 15V$ , $R_S = 100\Omega$ , $R_L = 2k\Omega$ , $C_L = 50pF$ , Unless Otherwise Specified (Continued)

PARAMETER	TEST CONDITIONS	TEMP (°C)	HA-5101-2, -5; HA-5111-2, -5			HA-5101-9, HA-5111-9			UNITS
			MIN	TYP	MAX	MIN	TYP	MAX	
Maximum Load Capacitance		25	-	800	-	-	800	-	pF
<b>TRANSIENT RESPONSE</b> (Note 5)									
Rise Time	HA-5101	25	-	50	100	-	50	100	ns
	HA-5111	25	-	30	60	-	30	60	ns
Overshoot	HA-5101	25	-	20	35	-	20	35	%
	HA-5111	25	-	20	40	-	20	40	%
Slew Rate	HA-5101	25	6	10	-	6	10	-	V/ $\mu$ s
	HA-5111	25	40	50	-	40	50	-	V/ $\mu$ s
Settling Time (Note 6)	HA-5101 0.01%	-	-	2.6	-	-	2.6	-	$\mu$ s
	HA-5111 0.01%	-	-	0.5	-	-	0.5	-	$\mu$ s
<b>NOISE CHARACTERISTICS</b> (Note 7)									
Input Noise Voltage	f = 10Hz	25	-	5	7	-	5	7	nV/ $\sqrt{Hz}$
	f = 1kHz	25	-	3.0	4.0	-	3.0	4.0	nV/ $\sqrt{Hz}$
Input Noise Current	f = 10Hz	25	-	4.0	9	-	4.0	9	pA/ $\sqrt{Hz}$
	f = 1kHz		-	0.6	2.5	-	0.6	2.5	pA/ $\sqrt{Hz}$
Broadband Noise Voltage	f = DC To 30kHz	25	-	0.870	-	-	0.870	-	$\mu$ V <sub>RMS</sub>
<b>POWER SUPPLY CHARACTERISTICS</b>									
Supply Current HA-5101/5111		Full	-	4	6	-	4	7	mA
Power Supply Rejection Ratio	$\Delta V_S = \pm 5V$	Full	80	100	-	80	100	-	dB

**NOTES:**

3. Output current is measured with  $V_{OUT} = \pm 15V$  with  $V_{SUPPLY} = \pm 18V$ .
4. Full power bandwidth is guaranteed by equation: Full power bandwidth =  $\frac{\text{Slew Rate}}{2\pi V_{PEAK}}$ ,  $V_{PEAK} = 10V$ .
5. Refer to Test Circuits section of the data sheet.
6. Settling time is measured to 0.01% of final value for a 10V output step, and  $A_V = -10$  for HA-5111 and 0.01% of final value for a 10V output step,  $A_V = -1$  for HA-5101.
7. The limits for these parameters are guaranteed based on lab characterization, and reflect lot-to-lot variation.

## Test Circuits and Waveforms

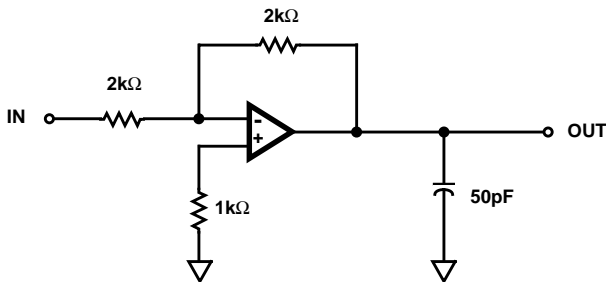

FIGURE 1. HA-5101 LARGE SIGNAL RESPONSE CIRCUIT

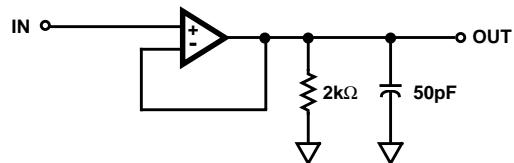
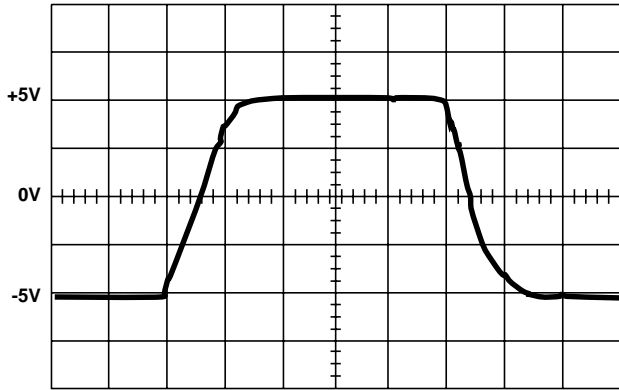

FIGURE 2. HA-5101 SMALL SIGNAL RESPONSE CIRCUIT

Test Circuits and Waveforms (Continued)



Ch. 1 = 2.5V/Div.  
Timebase = 200ns/Div.

FIGURE 3. HA-5111 LARGE SIGNAL TRANSIENT RESPONSE

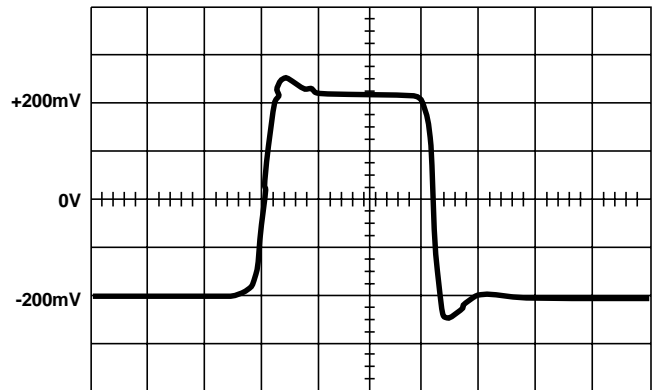

Ch. 1 = 100mV/Div.  
Timebase = 100ns/Div.

FIGURE 4. HA-5111 SMALL SIGNAL TRANSIENT RESPONSE

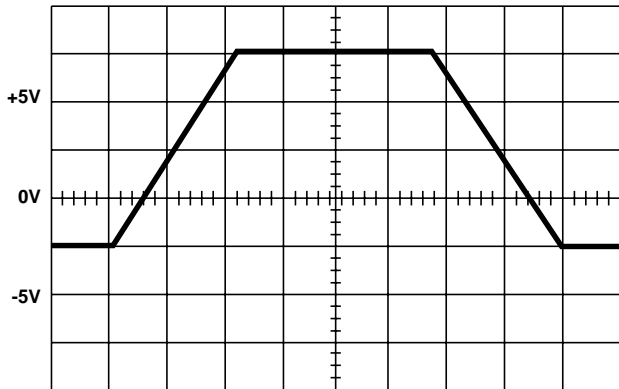

Ch. 1 = 2.5V/Div.  
Timebase = 1.00μs/Div.

FIGURE 5. HA-5101 LARGE SIGNAL TRANSIENT RESPONSE

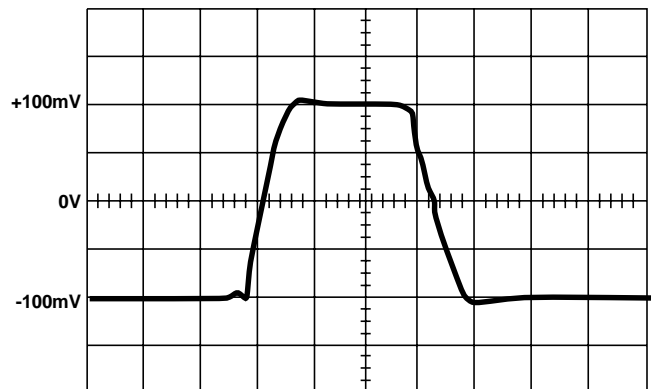

Ch. 1 = 50mV/Div.  
Timebase = 100ns/Div.

FIGURE 6. HA-5101 SMALL SIGNAL TRANSIENT RESPONSE

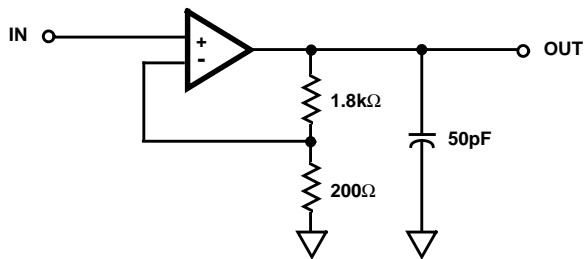
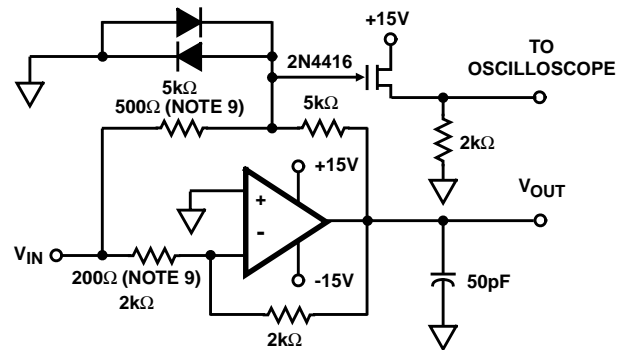

FIGURE 7. HA-5111 LARGE AND SMALL SIGNAL RESPONSE CIRCUIT



NOTES:

8.  $A_V = -1$  (HA-5101),  $A_V = -10$  (HA-5111).
9. Feedback and summing resistors should be 0.1% matched.
10. Clipping diodes are optional, HP5082-2810 recommended.

FIGURE 8. SETTLING TIME CIRCUIT

**Application Information**

**Operation At ±5V Supply**

The HA-5101/11 performs well at  $V_S = \pm 5V$  exhibiting typical characteristics as listed below:

$I_{CC}$ .....	3.7mA
$V_{IO}$ .....	0.5mV
$I_{BIAS}$ .....	56nA
$A_{VOL}$ ( $V_O = \pm 3V$ ) .....	106kV/V
$V_{OUT}$ .....	3.7V
$I_{OUT}$ .....	13mA
CMRR ( $\Delta V_{CM} = \pm 2.5V$ ) .....	90dB
PSRR ( $\Delta V_S = 0.5V$ ) .....	90dB
Unity Gain Bandwidth (5101) .....	10MHz
GBWP (5111) .....	100MHz
Slew Rate (5101) .....	7V/ $\mu$ s
Slew Rate (5111) .....	40V/ $\mu$ s

**Offset Adjustment**

The following is the recommended  $V_{IO}$  adjust configuration:

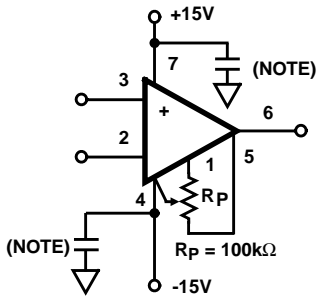

NOTE: Proper decoupling is always recommended, 0.1 $\mu$ F high quality capacitor should be at or very near the device's supply pins.

**Compensation**

An external compensation capacitor can be used with the HA-5111 connected between pin 8 and ground (or  $V_-$ ,  $V_+$  not Recommended). A plot of gain bandwidth product vs compensation capacitor has been included as a design aid. The capacitor should be a high frequency type mounted near the device leads to minimize parasitics.

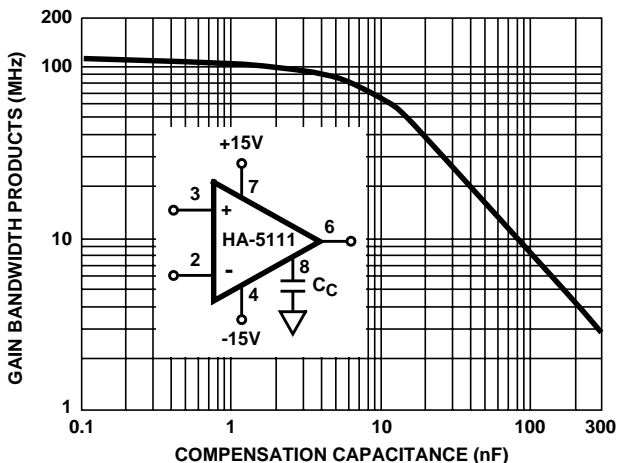

**Input Protection**

The HA-5101/11 has built-in back-to-back protection diodes which will limit the differential input voltage to approximately 7V. If the 5101/11 will be used in conditions where that voltage may be exceeded, then current limiting resistors must be used. No more than 25mA should be allowed to flow in the HA-5101/11's input.

**Comparator Circuit**

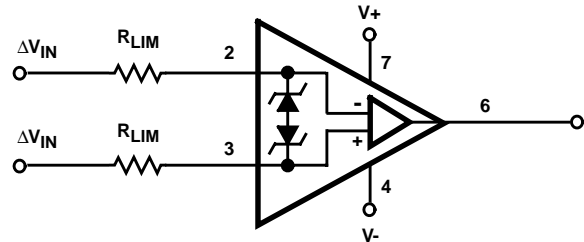

Choose  $R_{LIM}$  Such That: 
$$\frac{(\Delta V_{INMAX} - 7V)}{25mA} \leq 2R_{LIM}$$

**Output Saturation**

When an op amp is overdriven, output devices can saturate and sometimes take a long time to recover. Saturation can be avoided (sometimes) by using circuits such as:

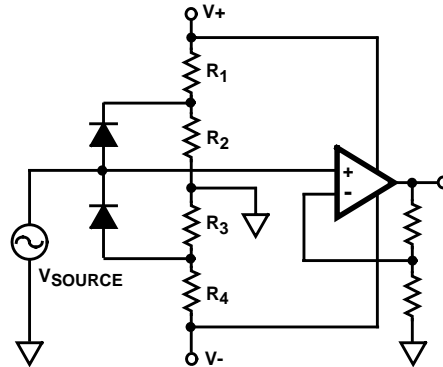

If saturation cannot be avoided the HA-5101/11 recovers from a 25% overdrive in about 6.5 $\mu$ s (see photos).

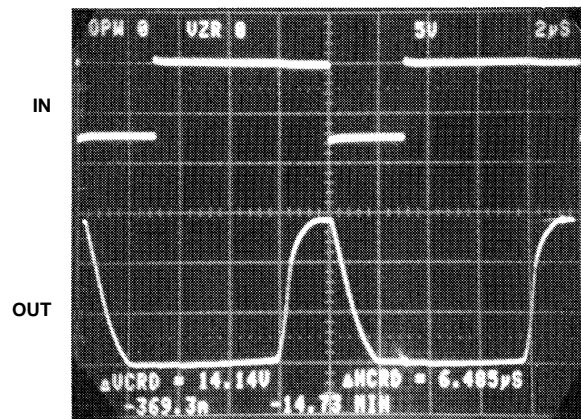

Top: Input  
Bottom: Output, 5V/Div., 2 $\mu$ s/Div.  
Output is overdriven negative and recovers in 6 $\mu$ s.

Typical Performance Curves

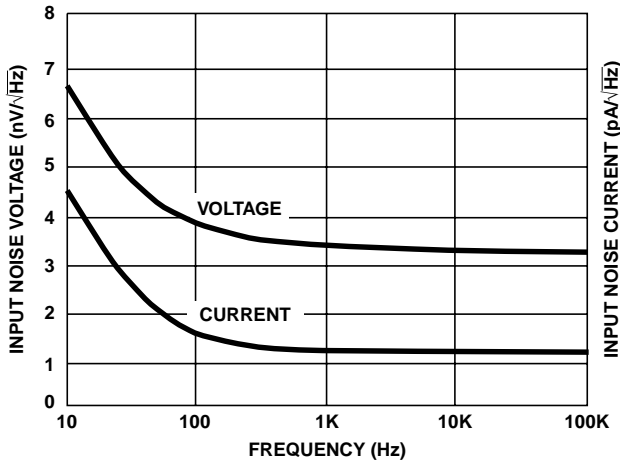

FIGURE 9. HA-5101/11 NOISE SPECTRUM

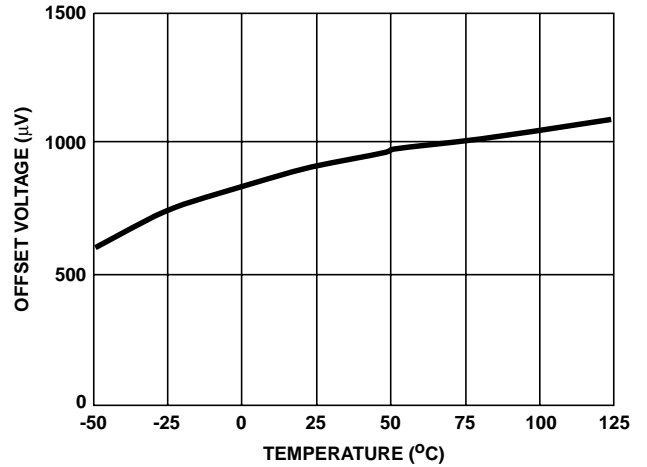
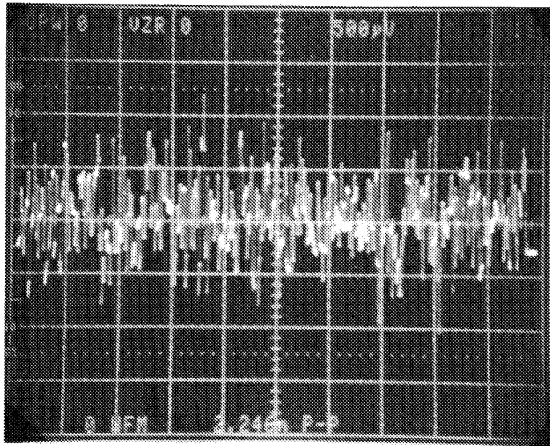
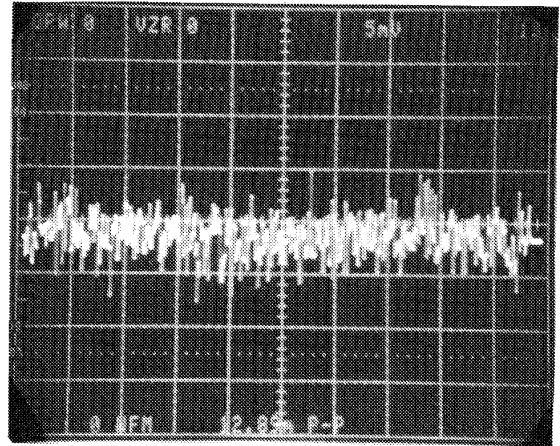

FIGURE 10. OFFSET VOLTAGE vs TEMPERATURE



$A_V = 25000$ ,  $V_S = \pm 15V$  (2.25  $\mu V_{P-P}$  RTO)  
PEAK-TO-PEAK NOISE 0.1Hz TO 10Hz



$A_V = 25000$ ,  $V_S = \pm 15V$  (12.89m  $V_{P-P}$  RTO)  
PEAK-TO-PEAK TOTAL NOISE 0.1Hz TO 1MHz

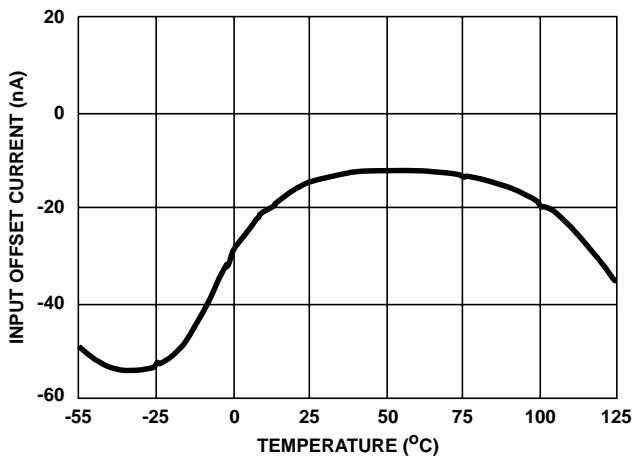

FIGURE 11. INPUT OFFSET CURRENT vs TEMPERATURE

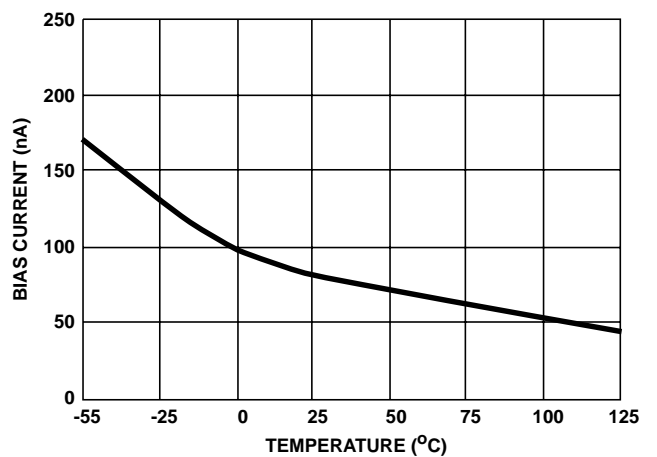

FIGURE 12. INPUT BIAS CURRENT vs TEMPERATURE

Typical Performance Curves (Continued)

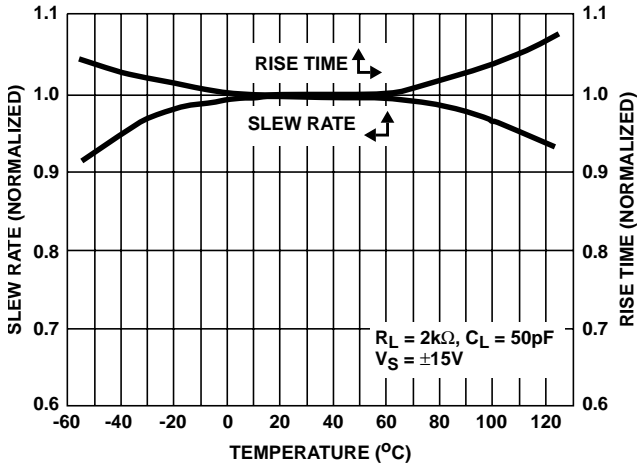

FIGURE 13. SLEW RATE/RISE TIME vs TEMPERATURE

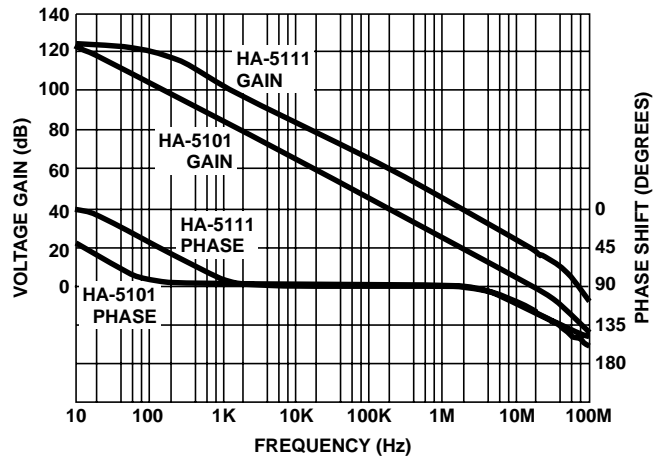

FIGURE 14. OPEN-LOOP GAIN/PHASE vs FREQUENCY

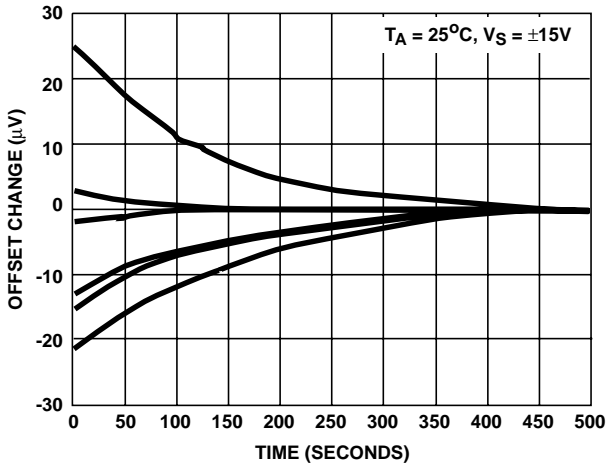

FIGURE 15. INPUT OFFSET WARMUP DRIFT vs TIME (NORMALIZED TO ZERO FINAL VALUE) (SIX REPRESENTATIVE UNITS)

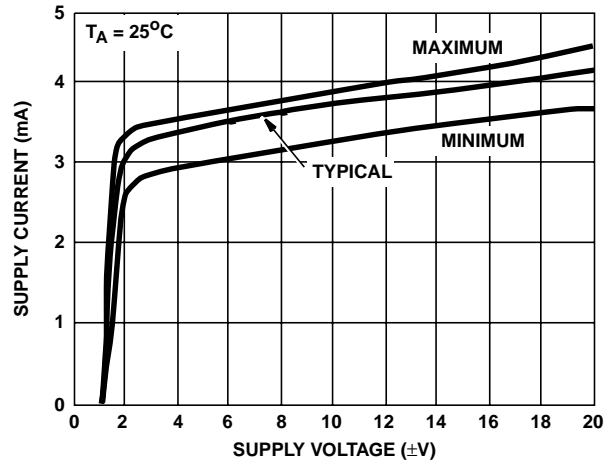

FIGURE 16. SUPPLY CURRENT vs SUPPLY VOLTAGE

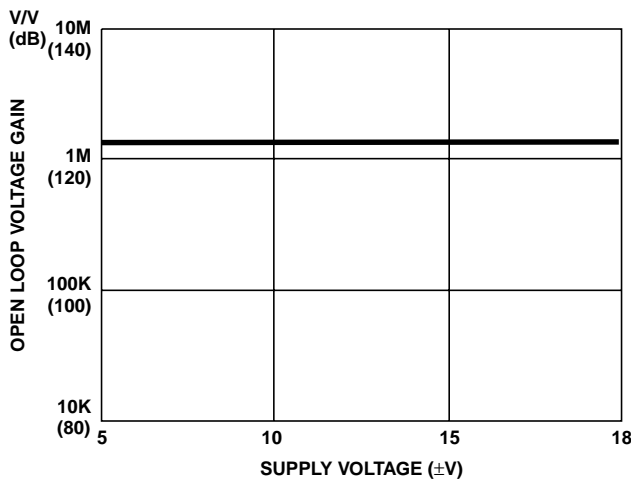

FIGURE 17. DC OPEN-LOOP VOLTAGE GAIN vs SUPPLY VOLTAGE

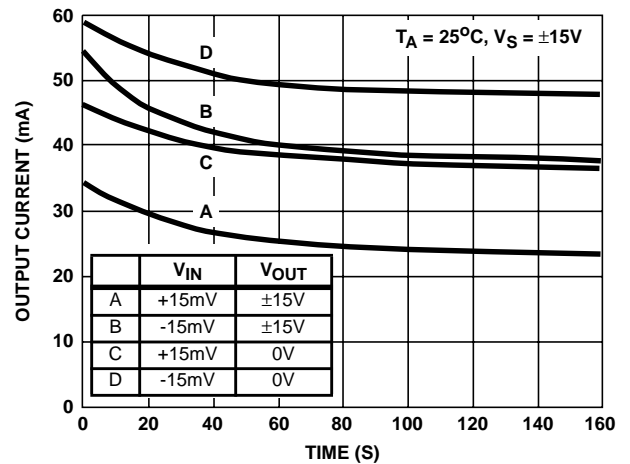

FIGURE 18. SHORT CIRCUIT CURRENT vs TIME



Typical Performance Curves (Continued)

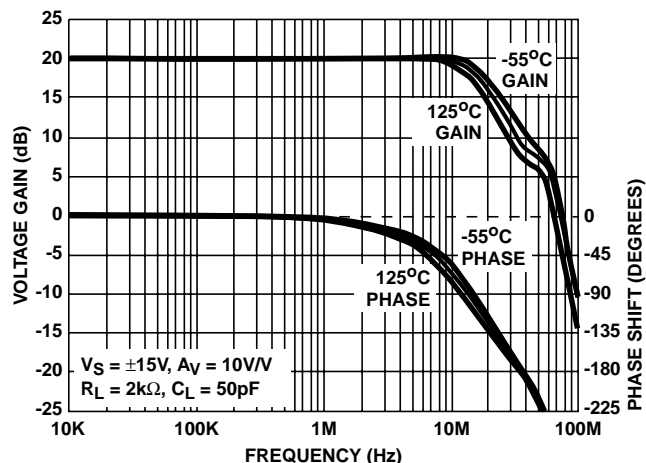

FIGURE 19. HA-5111 FREQUENCY RESPONSE

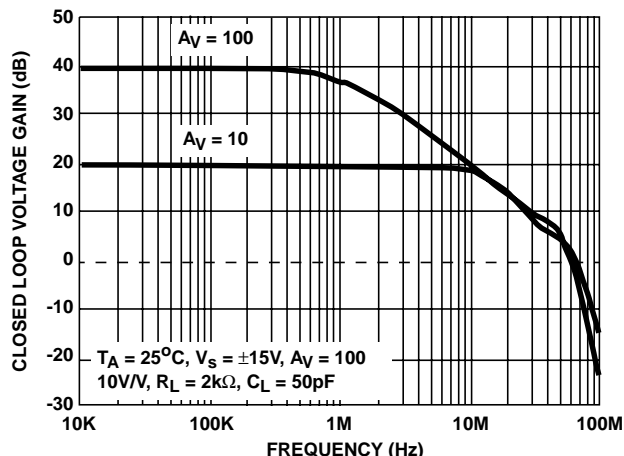

FIGURE 20. HA-5111 CLOSED-LOOP GAIN vs FREQUENCY

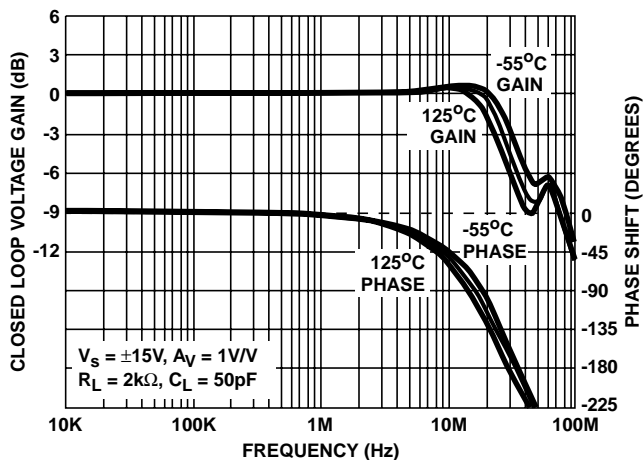

FIGURE 21. HA-5101 FREQUENCY RESPONSE

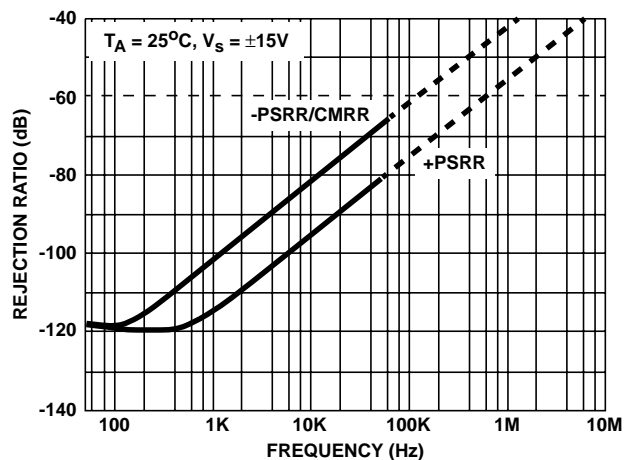

FIGURE 22. HA-5111 REJECTION RATIOS vs FREQUENCY

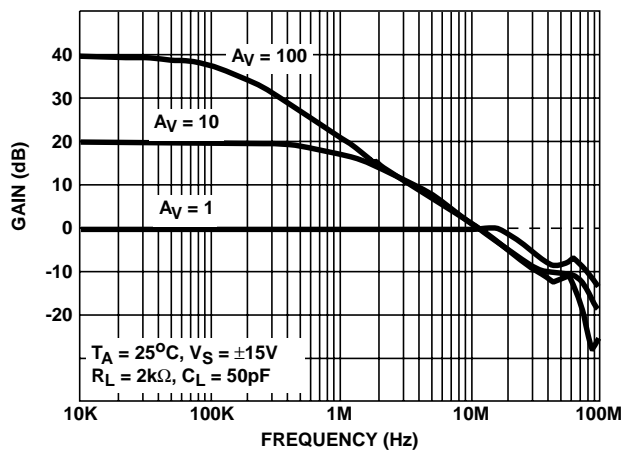

FIGURE 23. HA-5101 CLOSED-LOOP GAIN vs FREQUENCY

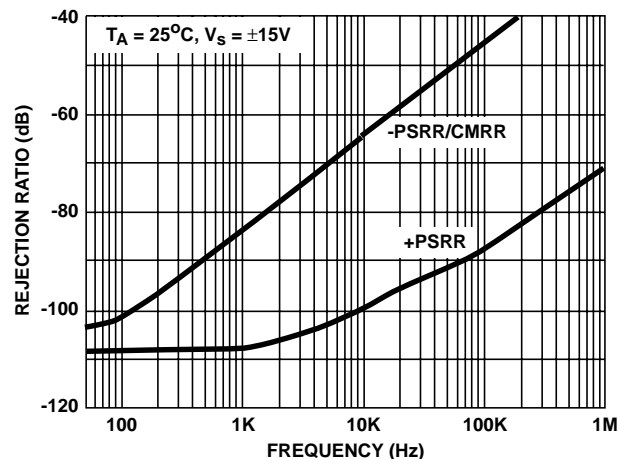

FIGURE 24. HA-5101 REJECTION RATIOS vs FREQUENCY

Typical Performance Curves (Continued)

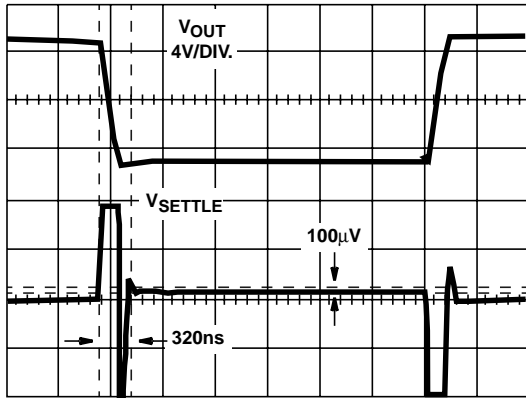

FIGURE 25. HA-5111 SETTling WAVEFORM 500ns/DIV.

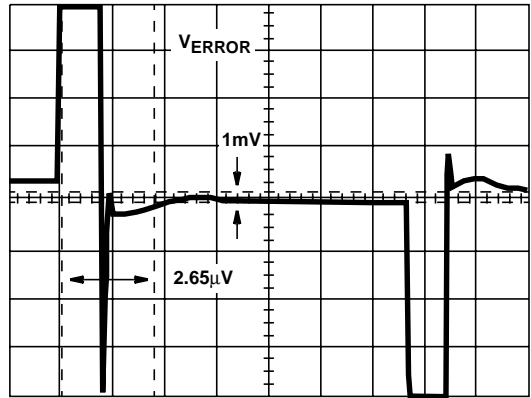

FIGURE 26. HA-5101 SETTling WAVEFORM 1.5µs/DIV.

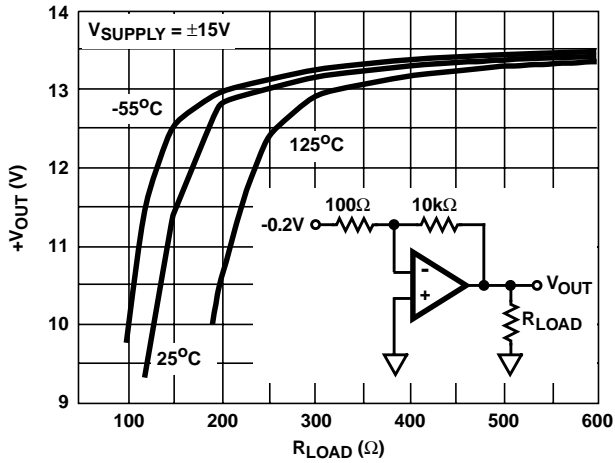

FIGURE 27. HA-5101 +V<sub>OUT</sub> vs R<sub>L</sub>

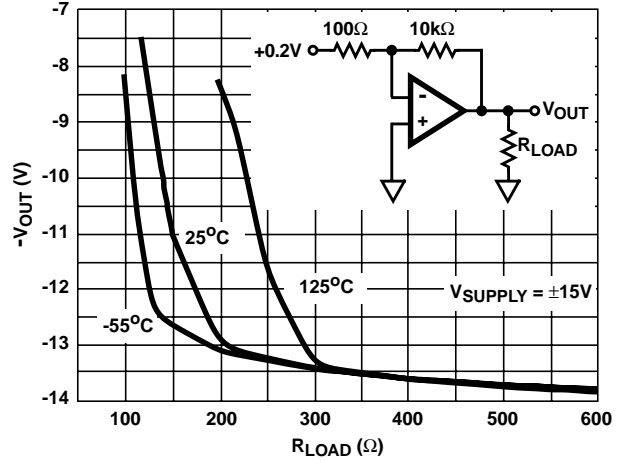

FIGURE 28. HA-5101 -V<sub>OUT</sub> vs R<sub>L</sub>

# HA-5101, HA-5111

## Die Characteristics

### DIE DIMENSIONS:

70 mils x 70 mils x 19 mils  
1790 $\mu$ m x 1780 $\mu$ m x 483 $\mu$ m

### METALLIZATION:

Type: Al, 1% Cu  
Thickness: 16k $\text{\AA}$   $\pm$  2k $\text{\AA}$

### PASSIVATION:

Type: Nitride ( $\text{Si}_3\text{N}_4$ ) over Silox ( $\text{SiO}_2$ , 5% Phos.)  
Silox Thickness: 12k $\text{\AA}$   $\pm$  2k $\text{\AA}$   
Nitride Thickness: 3.5k $\text{\AA}$   $\pm$  1.5k $\text{\AA}$

**SUBSTRATE POTENTIAL (Powered Up): V-**

**TRANSISTOR COUNT: 54**

**PROCESS: Bipolar Dielectric Isolation**

## Metallization Mask Layout

