

OBSOLETE PRODUCT
 Recommended Replacements: HFA1100, HFA1105
 or contact our Technical Support Center at
 1-888-INTERSIL or www.intersil.com/tsc

Ultra High Slew Rate Operational Amplifier

The HFA-0001 is an all bipolar op amp featuring high slew rate (1000V/μs), and high unity gain bandwidth (350MHz). These features combined with fast settling time (25ns) make this product very useful in high speed data acquisition systems as well as RF, video, and pulse amplifier designs. Other outstanding characteristics include low bias currents (15μA), low offset current (18μA), and low offset voltage (6mV).

The HFA-0001 offers high performance at low cost. It can replace hybrids and RF transistor amplifiers, simplifying designs while providing increased reliability due to monolithic construction. To enhance the ease of design, the HFA-0001 has a 50Ω ±20% resistor connected from the output of the op amp to a separate pin. This can be used when driving 50Ω strip line, microstrip, or coax cable.

Features

- Unity Gain Bandwidth. 350MHz
- Full Power Bandwidth 53MHz
- High Slew Rate 1000V/μs
- High Output Drive. ±50mA
- Monolithic Construction

Applications

- RF/IF Processors
- Video Amplifiers
- High Speed Cable Drivers
- Pulse Amplifiers
- High Speed Communications
- Fast Data Acquisition Systems

Part Number Information

PART NUMBER	TEMPERATURE RANGE	PACKAGE
HFA1-0001-5	0°C to +75°C	14 Lead Ceramic Sidebrazed DIP
HFA1-0001-9	-40°C to +85°C	14 Lead Ceramic Sidebrazed DIP
HFA3-0001-5	0°C to +75°C	8 Lead Plastic DIP
HFA3-0001-9	-40°C to +85°C	8 Lead Plastic DIP
HFA9P0001-5	0°C to +75°C	16 Lead Widebody SOIC

Pinouts

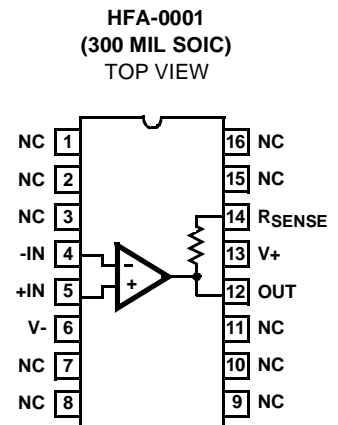
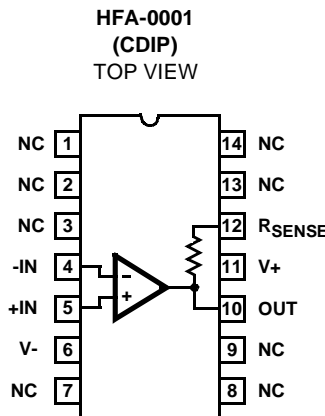
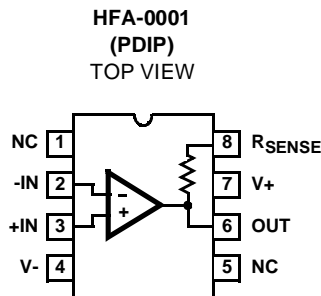

HFA-0001

Absolute Maximum Ratings (Note 1)

Supply Voltage (Between V+ and V- Terminals)	12V
Differential Input Voltage	±5V
Input Voltage	±4V
Output Current	60mA
Junction Temperature (Note 9)	+175°C
Junction Temperature (Plastic Package)	+150°C
Lead Temperature (Soldering 10 Sec.)	+300°C

Operating Conditions

Operating Temperature Range	-40°C ≤ T _A ≤ +85°C
HFA-0001-9	-40°C ≤ T _A ≤ +85°C
HFA-0001-5	0°C ≤ T _A ≤ +75°C
Storage Temperature Range	-65°C ≤ T _A ≤ +150°C

CAUTION: Stresses above those listed in "Absolute Maximum Ratings" may cause permanent damage to the device. This is a stress only rating and operation of the device at these or any other conditions above those indicated in the operational sections of this specification is not implied.

Electrical Specifications V+ = +5V, V- = -5V, Unless Otherwise Specified

PARAMETER	TEMP	HFA-0001-9			HFA-0001-5			UNITS	
		MIN	TYP	MAX	MIN	TYP	MAX		
INPUT CHARACTERISTICS									
Offset Voltage	+25°C	-	6	15	-	6	30	mV	
	High	-	4.5	20	-	4.5	30	mV	
	Low	-	12.5	45	-	12.5	35	mV	
Average Offset Voltage Drift	High	-	50	-	-	50	-	μV/°C	
	Low	-	100	-	-	100	-	μV/°C	
Bias Current	+25°C	-	15	50	-	15	100	μA	
	Full	-	20	50	-	20	100	μA	
Offset Current	+25°C	-	18	25	-	18	50	μA	
	Full	-	22	50	-	22	50	μA	
Common Mode Range	+25°C	±3	-	-	±3	-	-	V	
Differential Input Resistance	+25°C	-	10	-	-	10	-	kΩ	
Input Capacitance	+25°C	-	2	-	-	2	-	pF	
Input Noise Voltage	0.1Hz to 10Hz	+25°C	-	3.5	-	-	3.5	-	μVrms
	10Hz to 1MHz	+25°C	-	6.7	-	-	6.7	-	μVrms
Input Noise Voltage	f _O = 10Hz	+25°C	-	640	-	-	640	-	nV/√Hz
	f _O = 100Hz	+25°C	-	170	-	-	170	-	nV/√Hz
	f _O = 100kHz	+25°C	-	6	-	-	6	-	nV/√Hz
Input Noise Current	f _O = 10Hz	+25°C	-	2.35	-	-	2.35	-	nA/√Hz
	f _O = 100Hz	+25°C	-	0.57	-	-	0.57	-	nA/√Hz
	f _O = 1000Hz	+25°C	-	0.16	-	-	0.16	-	nA/√Hz
TRANSFER CHARACTERISTICS									
Large Signal Voltage Gain (Note 2)	+25°C	150	200	-	150	200	-	V/V	
	High	150	170	-	100	170	-	V/V	
	Low	150	220	-	150	220	-	V/V	
Common Mode Rejection Ratio (Note 3)	+25°C	45	47	-	42	47	-	dB	
	High	40	45	-	40	45	-	dB	
	Low	45	48	-	42	48	-	dB	
Unity Gain Bandwidth	+25°C	-	350	-	-	350	-	MHz	
Minimum Stable Gain	Full	1	-	-	1	-	-	V/V	
OUTPUT CHARACTERISTICS									
Output Voltage Swing	R _L = 100Ω	+25°C	-	±3.5	-	-	±3.5	-	V

HFA-0001

Electrical Specifications $V_+ = +5V$, $V_- = -5V$, Unless Otherwise Specified (Continued)

PARAMETER	TEMP	HFA-0001-9			HFA-0001-5			UNITS	
		MIN	TYP	MAX	MIN	TYP	MAX		
	$R_L = 1k\Omega$	+25°C	±3.5	±3.7	-	±3.5	±3.7	-	V
		High	±3.0	±3.6	-	±3.0	±3.6	-	V
		Low	±3.5	±3.7	-	±3.5	±3.7	-	V
Full Power Bandwidth (Note 5)		+25°C	-	53	-	-	53	-	MHz
Output Resistance, Open Loop		+25°C	-	3	-	-	3	-	Ω
Output Current		Full	±30	±50	-	±30	±50	-	mA
TRANSIENT RESPONSE									
Rise Time (Note 4, 6)		+25°C	-	480	-	-	480	-	ps
Slew Rate (Note 4, 7)	$R_L = 1k\Omega$	+25°C	-	1000	-	-	1000	-	V/ μ s
	$R_L = 100\Omega$	+25°C	-	875	-	-	875	-	V/ μ s
Settling Time (3V Step)	0.1%	+25°C	-	25	-	-	25	-	ns
Overshoot (Note 4, 6)		+25°C	-	36	-	-	36	-	%
POWER SUPPLY CHARACTERISTICS									
Supply Current		Full	-	65	75	-	65	75	mA
Power Supply Rejection Ratio (Note 8)		+25°C	40	42	-	37	42	-	dB
		High	35	41	-	35	41	-	dB
		Low	40	42	-	37	42	-	dB

NOTES:

- Absolute Maximum Ratings are limiting values applied individually beyond which the serviceability of the circuit may be impaired. Functional operation under any of these conditions is not necessarily implied.
- $V_{OUT} = 0$ to $\pm 2V$, $R_L = 1k\Omega$.
- $\Delta V_{CM} = \pm 2V$.
- $R_L = 100\Omega$.
- Full Power Bandwidth is calculated by equation: $FPBW = \frac{SlewRate}{2\pi V_{PEAK}}$, $V_{PEAK} = 3.0V$.
- $V_{OUT} = \pm 200mV$, $A_V = +1$.
- $V_{OUT} = \pm 3V$, $A_V = +1$.
- $\Delta V_S = \pm 4V$ to $\pm 6V$.
- See Thermal Constants in 'Applications Information' text. Maximum power dissipation, including output load, must be designed to maintain the junction temperature below $+175^\circ C$ for hermetic packages, and below $+150^\circ C$ for plastic packages.

Schematic Diagram

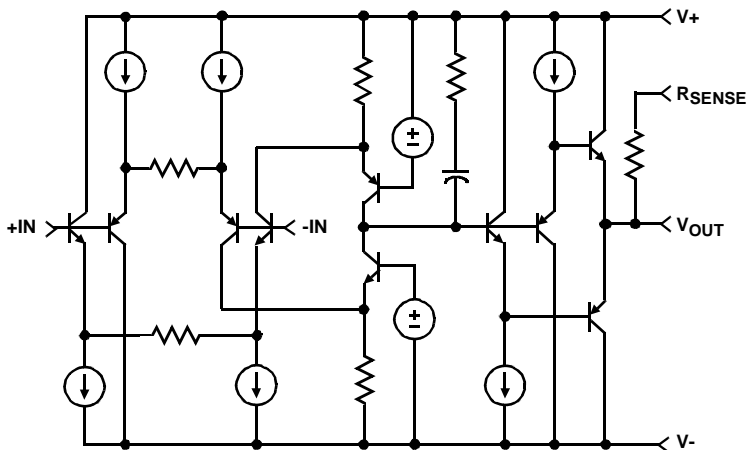

Die Characteristics

Thermal Constants ($^\circ C/W$)	θ_{JA}	θ_{JC}
HFA1-0001-5/-9	75	13
HFA3-0001-5	98	36
HFA9P-0001-5/-9	96	27

Test Circuits

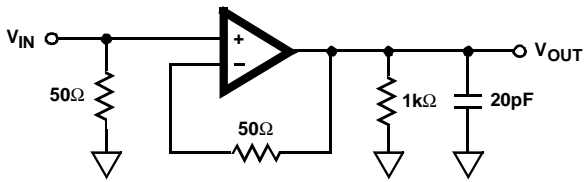

FIGURE 1. LARGE SIGNAL RESPONSE TEST CIRCUIT

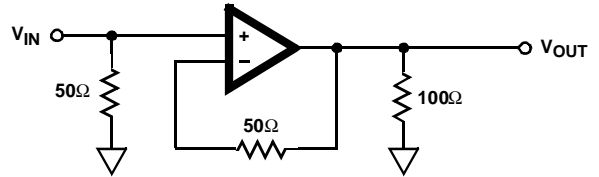
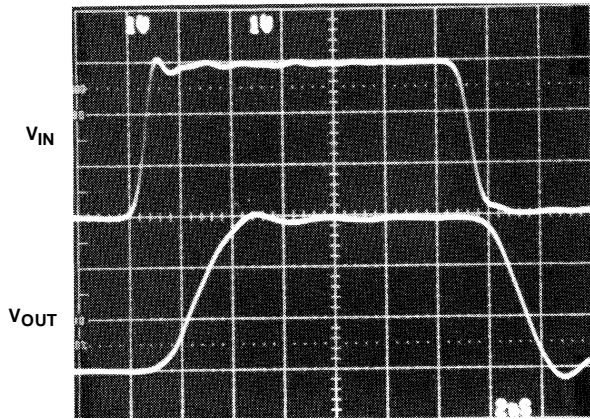

FIGURE 2. SMALL SIGNAL RESPONSE TEST CIRCUIT

LARGE SIGNAL RESPONSE

$V_{OUT} = 0V$ to $3V$
 Vertical Scale: $1V/Div.$
 Horizontal Scale: $2ns/Div.$



SMALL SIGNAL RESPONSE

$V_{OUT} = 0mV$ to $200mV$
 Vertical Scale: $100mV/Div.$
 Horizontal Scale: $2ns/Div.$

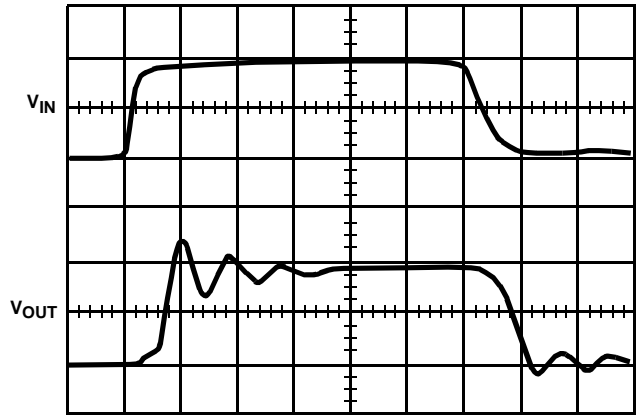

NOTE: Initial Step In Output Is Due To Fixture Feedthrough

PROPAGATION DELAY

Vertical Scale: $500mV/Div.$
 Horizontal Scale: $2ns/Div.$
 $A_V = +1$, $R_L = 100\Omega$, $V_{OUT} = 0V$ to $3V$

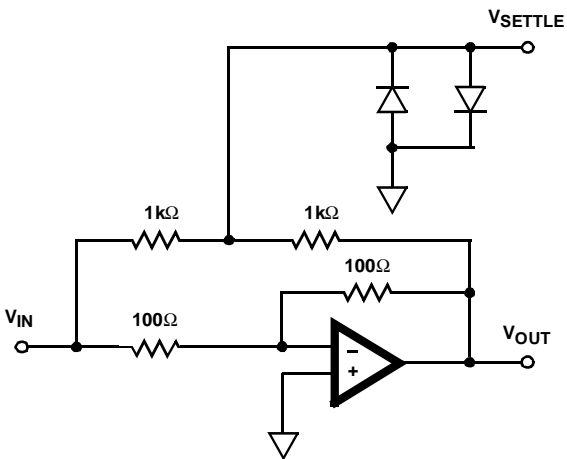

FIGURE 3. SETTLING TIME SCHEMATIC



NOTE: Test Fixture Delay of 450ps is Included

Typical Performance Curves $V_S = \pm 5V$, $T_A = +25^\circ C$, Unless Otherwise Specified

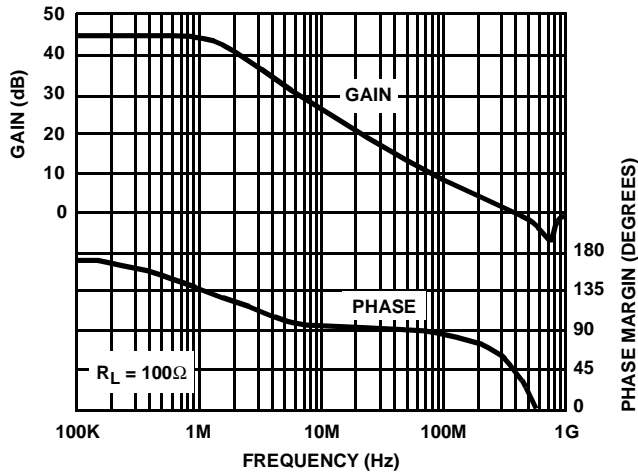

FIGURE 4. OPEN LOOP GAIN AND PHASE vs FREQUENCY

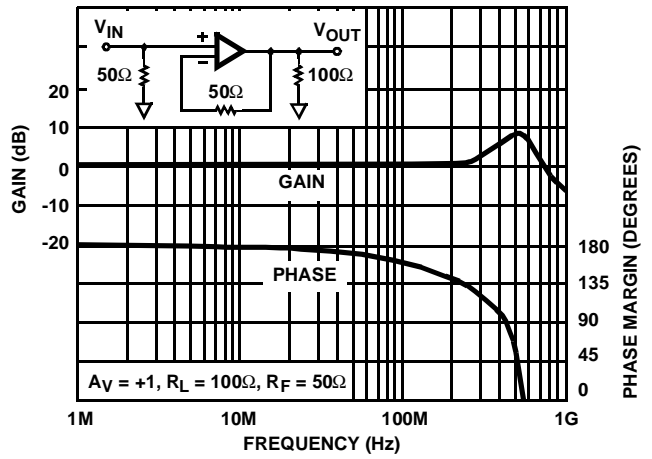

FIGURE 5. CLOSED LOOP GAIN vs FREQUENCY

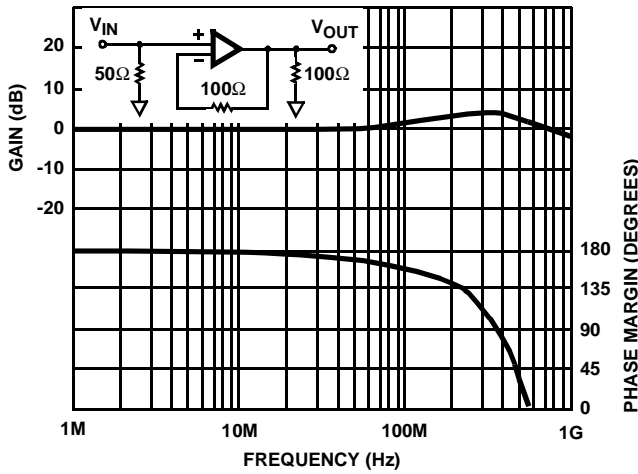

FIGURE 6. CLOSED LOOP GAIN vs FREQUENCY

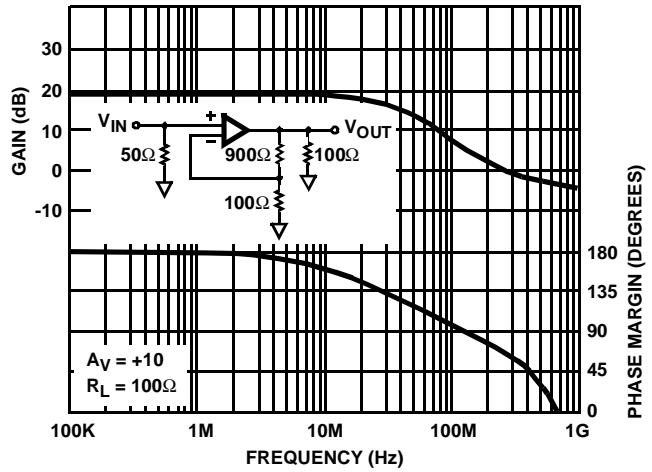

FIGURE 7. CLOSED LOOP GAIN vs FREQUENCY

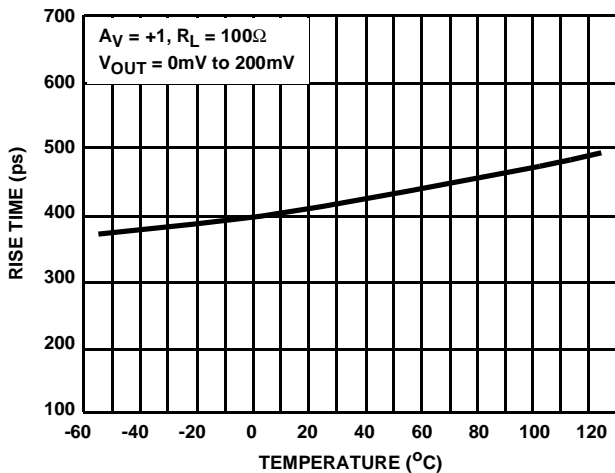

FIGURE 8. RISE TIME vs TEMPERATURE

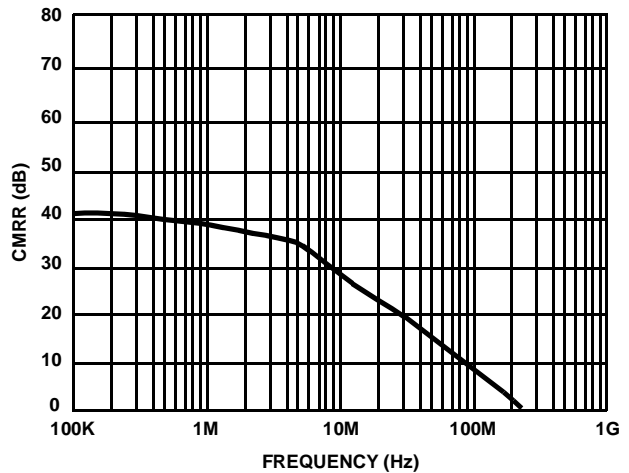

FIGURE 9. CMRR vs FREQUENCY

Typical Performance Curves $V_S = \pm 5V$, $T_A = +25^\circ C$, Unless Otherwise Specified (Continued)

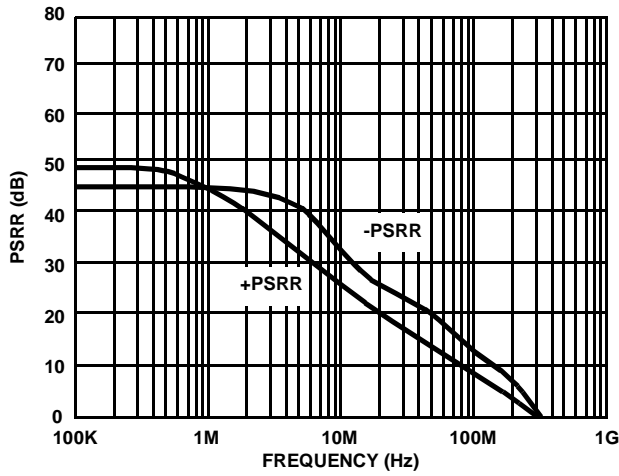

FIGURE 10. PSRR vs FREQUENCY

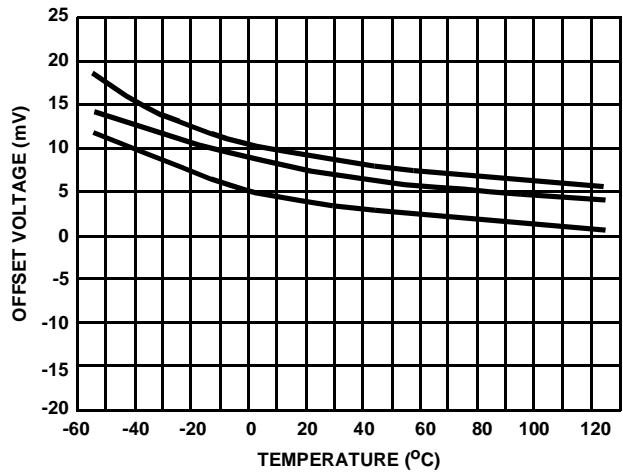

FIGURE 11. OFFSET VOLTAGE vs TEMPERATURE (3 REPRESENTATIVE UNITS)

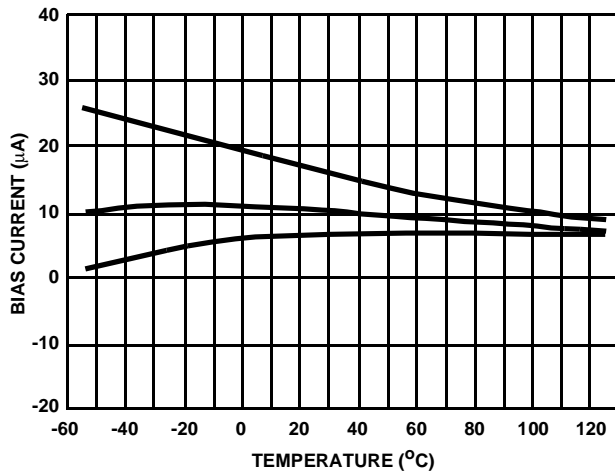

FIGURE 12. BIAS CURRENT vs TEMPERATURE (3 REPRESENTATIVE UNITS)

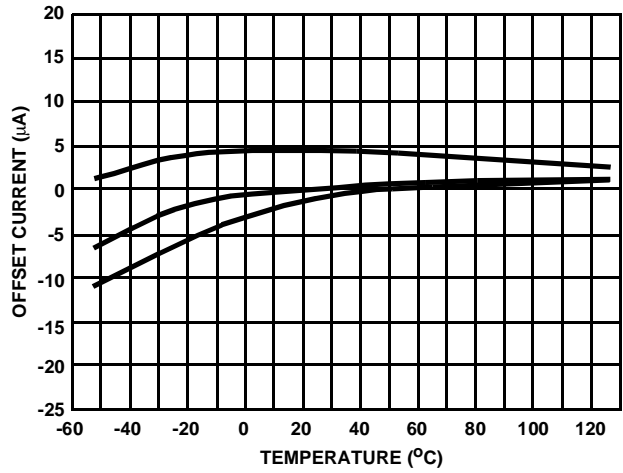

FIGURE 13. OFFSET CURRENT vs TEMPERATURE (3 REPRESENTATIVE UNITS)

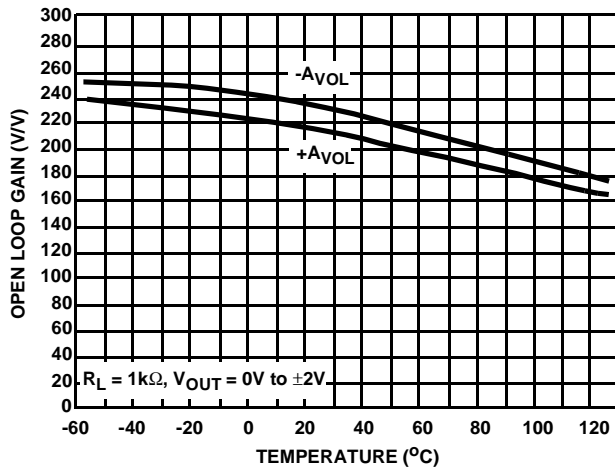

FIGURE 14. OPEN LOOP GAIN vs TEMPERATURE

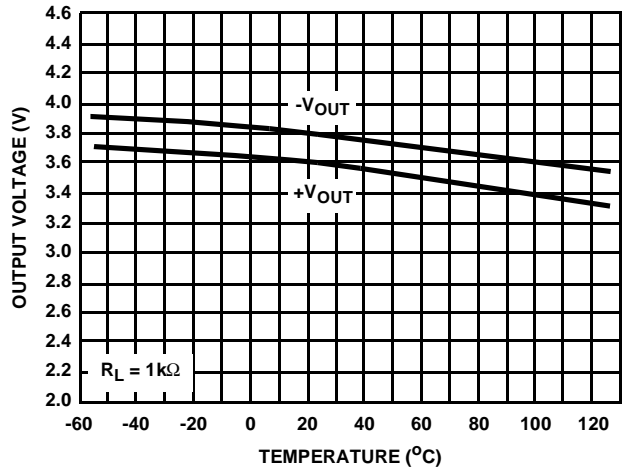

FIGURE 15. OUTPUT VOLTAGE SWING vs TEMPERATURE

Typical Performance Curves $V_S = \pm 5V$, $T_A = +25^\circ C$, Unless Otherwise Specified (Continued)

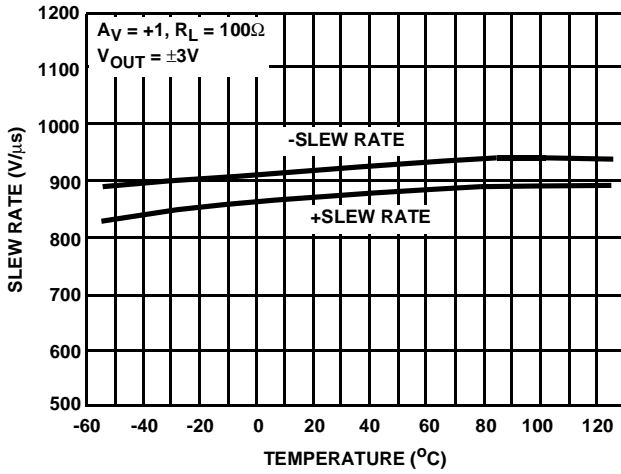

FIGURE 16. SLEW RATE vs TEMPERATURE

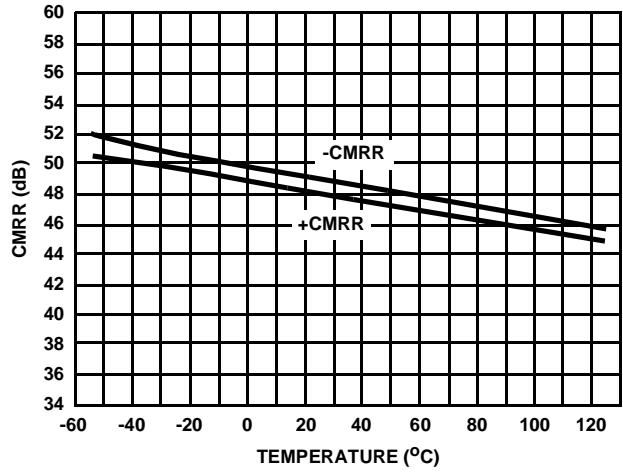

FIGURE 17. CMRR vs TEMPERATURE

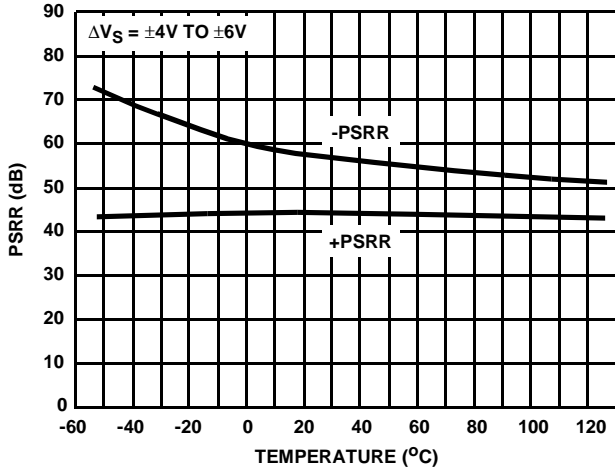

FIGURE 18. PSRR vs TEMPERATURE

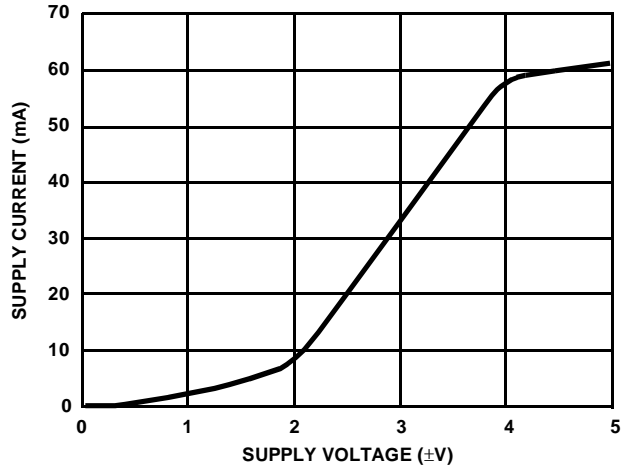

FIGURE 19. SUPPLY CURRENT vs SUPPLY VOLTAGE

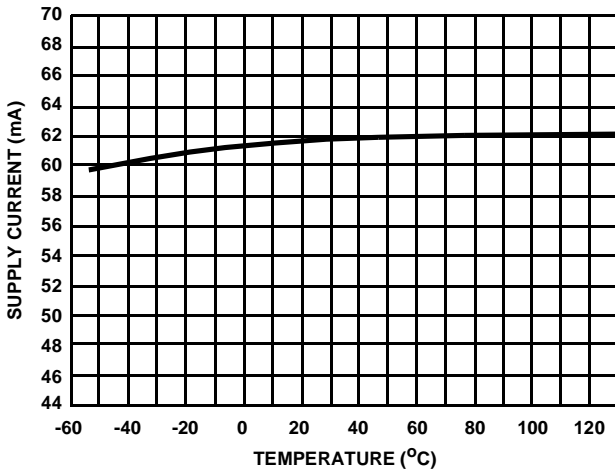

FIGURE 20. SUPPLY CURRENT vs TEMPERATURE

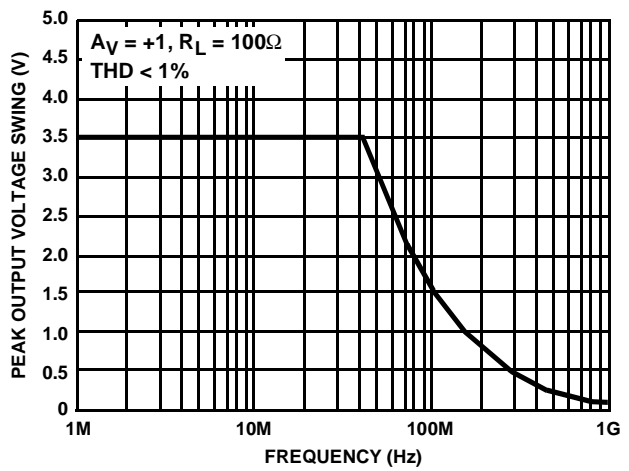

FIGURE 21. MAXIMUM OUTPUT VOLTAGE SWING vs FREQUENCY

Typical Performance Curves $V_S = \pm 5V$, $T_A = +25^\circ C$, Unless Otherwise Specified (Continued)

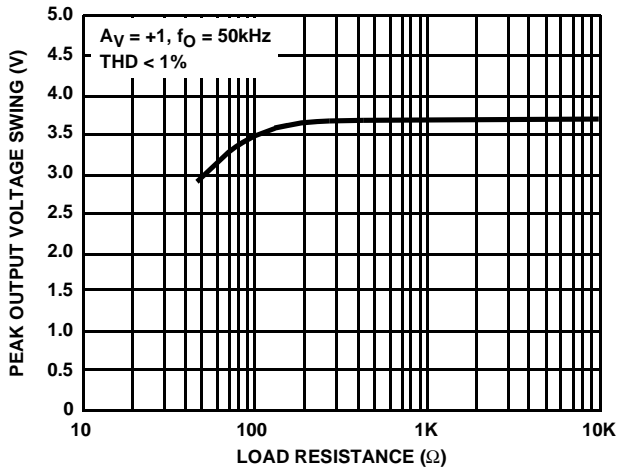

FIGURE 22. OUTPUT VOLTAGE SWING vs LOAD RESISTANCE

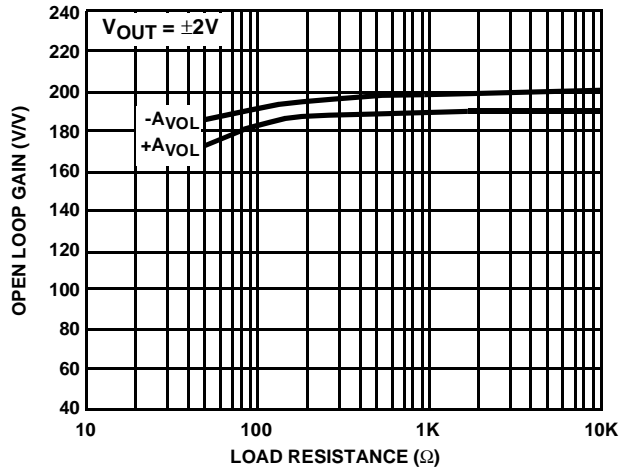

FIGURE 23. OPEN LOOP GAIN vs LOAD RESISTANCE

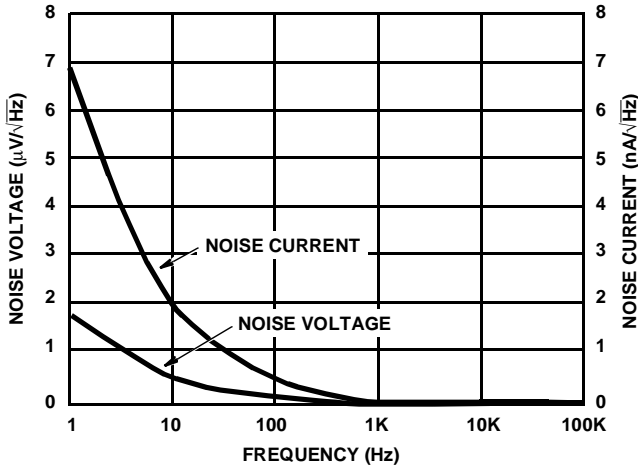

FIGURE 24. INPUT NOISE vs FREQUENCY

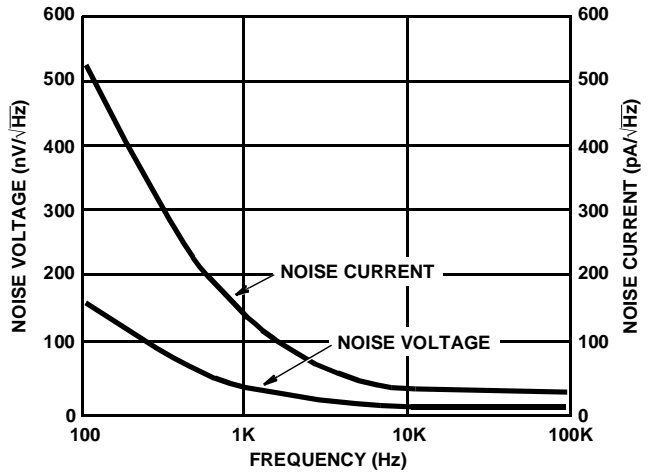

FIGURE 25. INPUT NOISE vs FREQUENCY

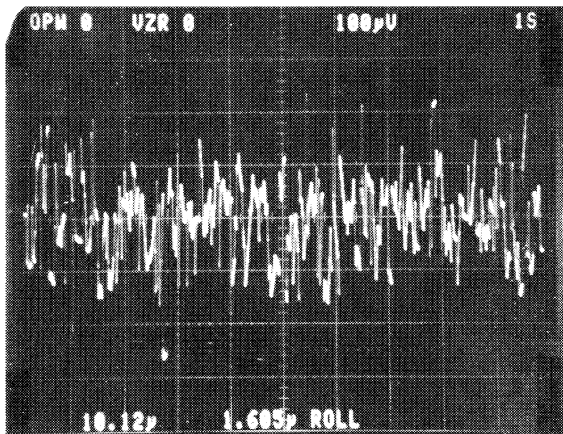

FIGURE 26. INPUT VOLTAGE NOISE 0.1Hz to 10Hz
 $A_V = 50$, Noise Voltage = $1.605\mu V_{rms}$ (RTI)
 Noise Voltage = $10.12\mu V_{p-p}$

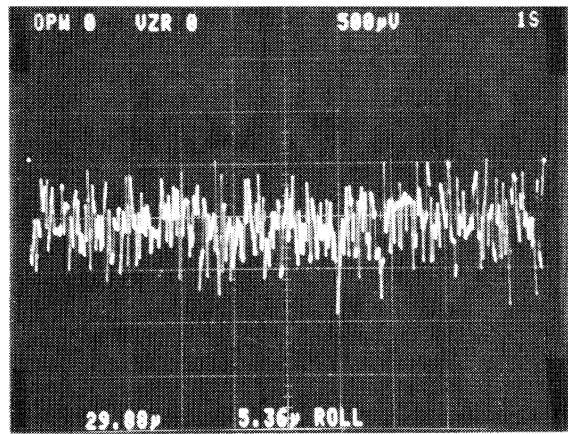

FIGURE 27. INPUT NOISE VOLTAGE 10Hz to 1MHz
 $A_V = 50$, Noise Voltage = $5.36\mu V_{rms}$ (RTI)
 Noise Voltage = $29.88\mu V_{p-p}$

Applications Information

Offset Adjustment

When applications require the offset voltage to be as low as possible, the figure below shows two possible schemes for adjusting offset voltage.

For a voltage follower application, use the circuit in Figure 29 without R_2 and with R_1 shorted. R_1 should be $1M\Omega$ to $10M\Omega$. The adjustment resistors will cause only a very small gain error.

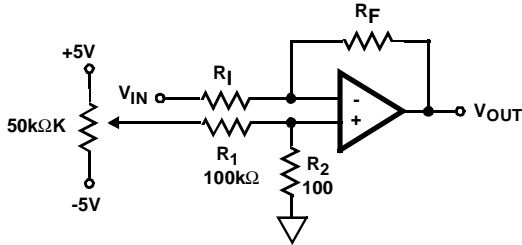

$$\text{Adjustment Range} \cong \pm V \left(\frac{R_2}{R_1} \right)$$

FIGURE 28. INVERTING GAIN

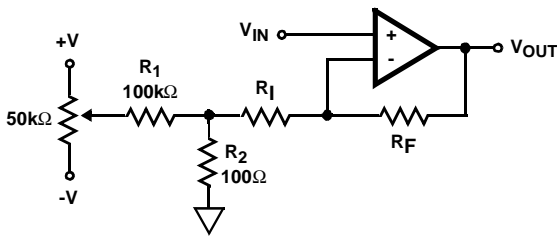

$$\text{Adjustment Range} \cong \pm V \left(\frac{R_2}{R_1} \right) \quad \text{Gain} \cong 1 + \left(\frac{R_F}{R_1 + R_2} \right)$$

FIGURE 29. NON-INVERTING GAIN

PC Board Layout Guidelines

When designing with the HFA-0001, good high frequency (RF) techniques should be used when making a PC board. A massive ground plane should be used to maintain a low impedance ground. Proper shielding and use of short interconnection leads are also very important.

To achieve maximum high frequency performance, the use of low impedance transmission lines with impedance matching is recommended: 50Ω lines are common in communications and 75Ω lines in video systems. Impedance matching is important to minimize reflected energy therefore minimizing transmitted signal distortion. This is accomplished by using a series matching resistor (50Ω or 75Ω), matched transmission line (50Ω or 75Ω), and a matched terminating resistor, as shown in Figure 30. Note that there will be a 6dB loss from input to output. The HFA-0001 has an integral $50\Omega \pm 20\%$ resistor connected to the op amps output with the other end of the resistor pinned out.

This 50Ω resistor can be used as the series resistor instead of an external resistor.

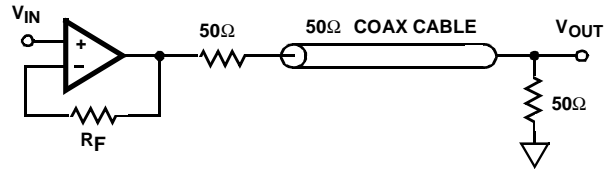

FIGURE 30.

PC board traces can be made to look like a 50Ω or 75Ω transmission line, called microstrip. Microstrip is a PC board trace with a ground plane directly beneath, on the opposite side of the board, as shown in Figure 31.

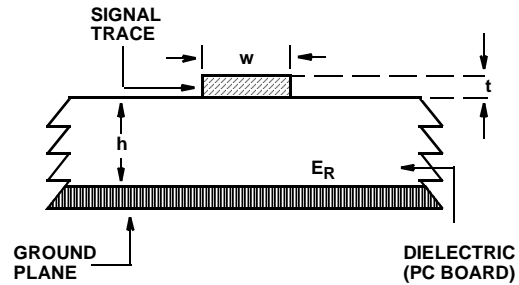

FIGURE 31.

When manufacturing pc boards, the trace width can be calculated based on a number of variables. The following equation is reasonably accurate for calculating the proper trace width for a 50Ω transmission line.

$$Z_0 = \frac{87}{\sqrt{E_R + 1.41}} \ln \left(\frac{5.98h}{0.8w + t} \right) \Omega$$

Power supply decoupling is essential for high frequency op amps. A $0.01\mu F$ high quality ceramic capacitor at each supply pin in parallel with a $1\mu F$ tantalum capacitor will provide excellent decoupling as shown in Figure 32.

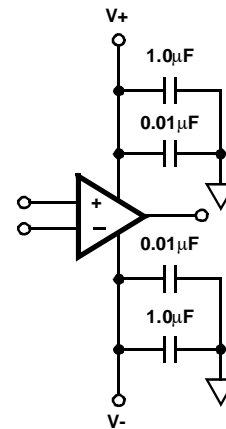

FIGURE 32. POWER SUPPLY DECOUPLING

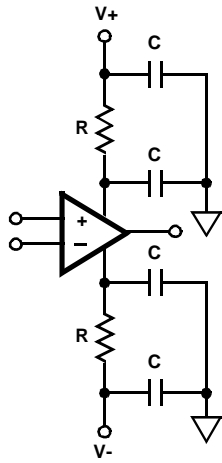

FIGURE 33. IMPROVED DECOUPLING/CURRENT LIMITING

Chip capacitors produce the best results due to ease of placement next to the op amp and they have negligible lead inductance. If leaded capacitors are used, the leads should be kept as short as possible to minimize lead inductance. Figures 32 and 33 illustrate two different decoupling schemes. Figure 33 improves the PSRR because the resistor and capacitors create low pass filters. Note that the supply current will create a voltage drop across the resistor.

Saturation Recovery

When an op amp is over driven output devices can saturate and sometimes take a long time to recover. By clamping the input to safe levels, output saturation can be avoided. If output saturation cannot be avoided, the recovery time from 25% over-drive is 20ns and 30ns from 50% over-drive.

Thermal Management

The HFA-0001 can sink and source a large amount of current making it very useful in many applications. Care must be taken not to exceed the power handling capability of the part to insure proper performance and maintain high reliability. The following graph shows the maximum power handling capability of the HFA-0001 without exceeding the maximum allowable junction temperature of +175°C. The curves also show the improved power handling capability when heatsinks are used based on AVVID heatsink #5801B for the 8 lead Plastic DIP and IERC heatsink #PEP50AB for the 14 lead Sidebrazed DIP. These curves are based on natural convection. Forced air will greatly improve the power dissipation capabilities of a heatsink.

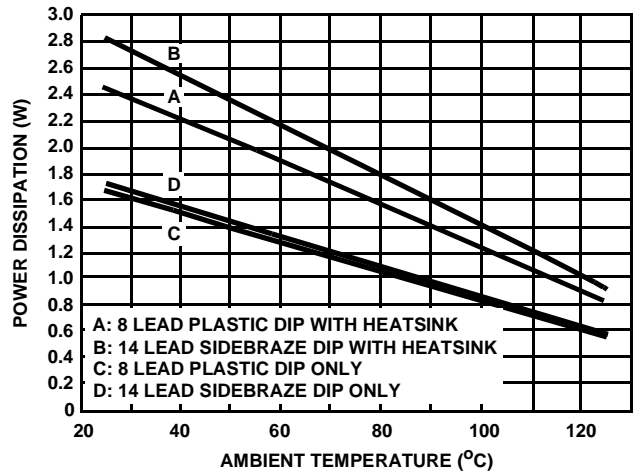

FIGURE 34.