

### Dual, 425MHz, Low Power, Video Operational Amplifier

The HFA1205 is a dual, high speed, low power current feedback amplifier built with Intersil's proprietary complementary bipolar UHF-1 process.

These amplifiers deliver 425MHz bandwidth and 1350V/μs slew rate, on only 60mW of quiescent power. They are specifically designed to meet the performance, power, and cost requirements of high volume video applications. The excellent gain flatness and differential gain/phase performance make these amplifiers well suited for component or composite video applications. Video performance is maintained even when driving a back terminated cable ( $R_L = 150\Omega$ ), and degrades only slightly when driving two back terminated cables ( $R_L = 75\Omega$ ). RGB applications will benefit from the high slew rates, and high full power bandwidth.

The HFA1205 is a pin compatible, low power, high performance upgrade for the popular Intersil HA5023. For a dual amplifier with output disable capability, please see the HFA1245 data sheet.

### Ordering Information

PART NUMBER (BRAND)	TEMP. RANGE (°C)	PACKAGE	PKG. NO.
HFA1205IP	-40 to 85	8 Ld PDIP	E8.3
HFA1205IB (H1205I)	-40 to 85	8 Ld SOIC	M8.15
HA5023EVAL	High Speed Op Amp DIP Evaluation Board		

### Features

- Low Supply Current . . . . . 5.8mA/Op Amp
- High Input Impedance . . . . . 2MΩ
- Wide -3dB Bandwidth ( $A_V = +2$ ) . . . . . 425MHz
- Very Fast Slew Rate . . . . . 1350V/μs
- Gain Flatness (to 50MHz) . . . . . ±0.04dB
- Differential Gain . . . . . 0.03%
- Differential Phase . . . . . 0.03 Degrees
- Pin Compatible Upgrade to HA5023

### Applications

- Flash A/D Drivers
- High Resolution Monitors
- Video Switching and Routing
- Professional Video Processing
- Video Digitizing Boards/Systems
- Multimedia Systems
- RGB Preamps
- Medical Imaging
- Hand Held and Miniaturized RF Equipment
- Battery Powered Communications
- High Speed Oscilloscopes and Analyzers

### Related Literature

- Technical Brief TB363 "Guidelines for Handling and Processing Moisture Sensitive Surface Mount Devices (SMDs)"

### Pinout

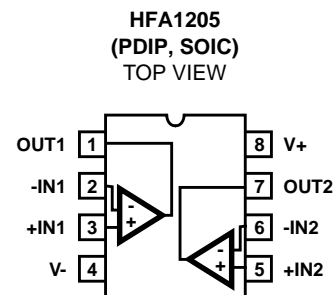

**Absolute Maximum Ratings**

Voltage Between V+ and V- .....	11V
DC Input Voltage .....	V <sub>SUPPLY</sub>
Differential Input Voltage .....	8V
Output Current (Note 2) .....	Short Circuit Protected
	30mA Continuous
	60mA ≤ 50% Duty Cycle
ESD Rating	
Human Body Model (Per MIL-STD-883 Method 3015.7) ...	600V

**Thermal Information**

Thermal Resistance (Typical, Note 1)	θ <sub>JA</sub> (°C/W)
PDIP Package .....	105
SOIC Package .....	160
Maximum Junction Temperature (Plastic Package) .....	150°C
Maximum Storage Temperature Range .....	-65°C to 150°C
Maximum Lead Temperature (Soldering 10s) .....	300°C
	(SOIC - Lead Tips Only)

**Operating Conditions**

Temperature Range .....

*CAUTION: Stresses above those listed in "Absolute Maximum Ratings" may cause permanent damage to the device. This is a stress only rating and operation of the device at these or any other conditions above those indicated in the operational sections of this specification is not implied.*

**NOTES:**

1. θ<sub>JA</sub> is measured with the component mounted on a low effective thermal conductivity test board in free air. See Tech Brief TB379 for details.
2. Output is short circuit protected to ground. Brief short circuits to ground will not degrade reliability, however continuous (100% duty cycle) output current must not exceed 30mA for maximum reliability.

**Electrical Specifications** V<sub>SUPPLY</sub> = ±5V, A<sub>V</sub> = +1, R<sub>F</sub> = 560Ω, R<sub>L</sub> = 100Ω, Unless Otherwise Specified

PARAMETER	TEST CONDITIONS	(NOTE 3) TEST LEVEL	TEMP. (°C)	MIN	TYP	MAX	UNITS
<b>INPUT CHARACTERISTICS</b>							
Input Offset Voltage		A	25	-	2	5	mV
		A	Full	-	3	8	mV
Average Input Offset Voltage Drift		B	Full	-	1	10	μV/°C
Input Offset Voltage Common-Mode Rejection Ratio	ΔV <sub>CM</sub> = ±1.8V	A	25	45	48	-	dB
	ΔV <sub>CM</sub> = ±1.8V	A	85	43	46	-	dB
	ΔV <sub>CM</sub> = ±1.2V	A	-40	43	46	-	dB
Input Offset Voltage Power Supply Rejection Ratio	ΔV <sub>PS</sub> = ±1.8V	A	25	48	52	-	dB
	ΔV <sub>PS</sub> = ±1.8V	A	85	46	50	-	dB
	ΔV <sub>PS</sub> = ±1.2V	A	-40	46	50	-	dB
Non-Inverting Input Bias Current		A	25	-	6	15	μA
		A	Full	-	10	25	μA
Non-Inverting Input Bias Current Drift		B	Full	-	5	60	nA/°C
Non-Inverting Input Bias Current Power Supply Sensitivity	ΔV <sub>PS</sub> = ±1.8V	A	25	-	0.5	1	μA/V
	ΔV <sub>PS</sub> = ±1.8V	A	85	-	0.8	3	μA/V
	ΔV <sub>PS</sub> = ±1.2V	A	-40	-	0.8	3	μA/V
Non-Inverting Input Resistance	ΔV <sub>CM</sub> = ±1.8V	A	25	0.8	2	-	MΩ
	ΔV <sub>CM</sub> = ±1.8V	A	85	0.5	1.3	-	MΩ
	ΔV <sub>CM</sub> = ±1.2V	A	-40	0.5	1.3	-	MΩ
Inverting Input Bias Current		A	25	-	2	8.5	μA
		A	Full	-	5	15	μA
Inverting Input Bias Current Drift		B	Full	-	60	200	nA/°C
Inverting Input Bias Current Common-Mode Sensitivity	ΔV <sub>CM</sub> = ±1.8V	A	25	-	3	6	μA/V
	ΔV <sub>CM</sub> = ±1.8V	A	85	-	4	8	μA/V
	ΔV <sub>CM</sub> = ±1.2V	A	-40	-	4	8	μA/V

## HFA1205

### Electrical Specifications $V_{SUPPLY} = \pm 5V$ , $A_V = +1$ , $R_F = 560\Omega$ , $R_L = 100\Omega$ , Unless Otherwise Specified (Continued)

PARAMETER	TEST CONDITIONS	(NOTE 3) TEST LEVEL	TEMP. (°C)	MIN	TYP	MAX	UNITS
Inverting Input Bias Current Power Supply Sensitivity	$\Delta V_{PS} = \pm 1.8V$	A	25	-	2	5	$\mu A/V$
	$\Delta V_{PS} = \pm 1.8V$	A	85	-	4	8	$\mu A/V$
	$\Delta V_{PS} = \pm 1.2V$	A	-40	-	4	8	$\mu A/V$
Inverting Input Resistance		C	25	-	55	-	$\Omega$
Input Capacitance		C	25	-	1.5	-	pF
Input Voltage Common Mode Range (Implied by $V_{IO}$ CMRR, $+R_{IN}$ , and $-I_{BIAS}$ CMS tests)		A	25, 85	$\pm 1.8$	$\pm 2.4$	-	V
		A	-40	$\pm 1.2$	$\pm 1.7$	-	V
Input Noise Voltage Density (Note 6)	$f = 100kHz$	B	25	-	3.5	-	$nV/\sqrt{Hz}$
Non-Inverting Input Noise Current Density (Note 6)	$f = 100kHz$	B	25	-	2.5	-	$pA/\sqrt{Hz}$
Inverting Input Noise Current Density (Note 6)	$f = 100kHz$	B	25	-	25	-	$pA/\sqrt{Hz}$
<b>TRANSFER CHARACTERISTICS</b>							
Open Loop Transimpedance Gain (Note 6)		C	25	-	400	-	k $\Omega$
<b>AC CHARACTERISTICS</b> $A_V = +2$ , $R_F = 464\Omega$ , Unless Otherwise Specified							
-3dB Bandwidth ( $V_{OUT} = 0.2V_{P-P}$ , Note 6)	$A_V = +1$ , $R_S = 432\Omega$	B	25	-	300	-	MHz
	$A_V = +2$	B	25	-	425	-	MHz
	$A_V = -1$ , $R_F = 332\Omega$	B	25	-	350	-	MHz
Full Power Bandwidth ( $V_{OUT} = 5V_{P-P}$ at $A_V = +2/-1$ , $4V_{P-P}$ at $A_V = +1$ , Note 6)	$A_V = +1$ , $R_S = 432\Omega$	B	25	-	135	-	MHz
	$A_V = +2$	B	25	-	130	-	MHz
	$A_V = -1$ , $R_F = 332\Omega$	B	25	-	200	-	MHz
Gain Flatness ( $A_V = +2$ , $V_{OUT} = 0.2V_{P-P}$ , Note 6)	To 25MHz	B	25	-	$\pm 0.04$	-	dB
	To 50MHz	B	25	-	$\pm 0.04$	-	dB
	To 100MHz	B	25	-	$\pm 0.07$	-	dB
Minimum Stable Gain		A	Full	-	1	-	V/V
Crosstalk ( $A_V = +2$ , Note 6)	5MHz	B	25	-	-60	-	dB
	10MHz	B	25	-	-54	-	dB
<b>OUTPUT CHARACTERISTICS</b>							
Output Voltage Swing (Note 6)	$A_V = -1$ , $R_L = 100\Omega$ $R_F = 560\Omega$	A	25	$\pm 3$	$\pm 3.5$	-	V
		A	Full	$\pm 2.8$	$\pm 3$	-	V
Output Current (Note 6)	$A_V = -1$ , $R_L = 50\Omega$ $R_F = 560\Omega$	A	25, 85	50	60	-	mA
		A	-40	28	42	-	mA
Output Short Circuit Current	$R_F = 560\Omega$	B	25	-	90	-	mA
Closed Loop Output Impedance (Note 6)	DC, $A_V = +2$ , $R_F = 464\Omega$	B	25	-	0.07	-	$\Omega$
Second Harmonic Distortion ( $A_V = +2$ , $R_F = 464\Omega$ , $V_{OUT} = 2V_{P-P}$ )	10MHz	B	25	-	-53	-	dBc
	20MHz	B	25	-	-45	-	dBc
Third Harmonic Distortion ( $A_V = +2$ , $R_F = 464\Omega$ , $V_{OUT} = 2V_{P-P}$ )	10MHz	B	25	-	-55	-	dBc
	20MHz	B	25	-	-50	-	dBc
<b>TRANSIENT CHARACTERISTICS</b> $A_V = +2$ , $R_F = 464\Omega$ , Unless Otherwise Specified							
Rise and Fall Times ( $V_{OUT} = 0.5V_{P-P}$ )	Rise Time	B	25	-	1.0	-	ns
	Fall Time	B	25	-	1.4	-	ns
Overshoot ( $V_{OUT} = 0$ to $0.5V$ , $V_{IN}$ $t_{RISE} = 1ns$ , Note 4)	+OS	B	25	-	5	-	%
	-OS	B	25	-	4	-	%
Overshoot ( $V_{OUT} = 0.5V_{P-P}$ , $V_{IN}$ $t_{RISE} = 1ns$ , Note 4)	+OS	B	25	-	5	-	%
	-OS	B	25	-	10	-	%

**Electrical Specifications**  $V_{SUPPLY} = \pm 5V$ ,  $A_V = +1$ ,  $R_F = 560\Omega$ ,  $R_L = 100\Omega$ , Unless Otherwise Specified **(Continued)**

PARAMETER	TEST CONDITIONS	(NOTE 3) TEST LEVEL	TEMP. (°C)	MIN	TYP	MAX	UNITS
Slew Rate ( $V_{OUT} = 4V_{P-P}$ , $A_V = +1$ , $+R_S = 432\Omega$ )	+SR	B	25	-	1150	-	V/ $\mu$ s
	-SR (Note 5)	B	25	-	800	-	V/ $\mu$ s
Slew Rate ( $V_{OUT} = 5V_{P-P}$ , $A_V = +2$ )	+SR	B	25	-	1425	-	V/ $\mu$ s
	-SR (Note 5)	B	25	-	900	-	V/ $\mu$ s
Slew Rate ( $V_{OUT} = 5V_{P-P}$ , $A_V = -1$ , $R_F = 332\Omega$ )	+SR	B	25	-	2400	-	V/ $\mu$ s
	-SR (Note 5)	B	25	-	1350	-	V/ $\mu$ s
Settling Time ( $V_{OUT} = +2V$ to 0V step, Note 6)	$T_o$ 0.1%	B	25	-	23	-	ns
	$T_o$ 0.05%	B	25	-	33	-	ns
	$T_o$ 0.025%	B	25	-	85	-	ns
Overdrive Recovery Time	$V_{IN} = \pm 2V$	B	25	-	10	-	ns
<b>VIDEO CHARACTERISTICS</b> $A_V = +2$ , $R_F = 464\Omega$ , Unless Otherwise Specified							
Differential Gain ( $f = 3.58MHz$ )	$R_L = 150\Omega$	B	25	-	0.03	-	%
	$R_L = 75\Omega$	B	25	-	0.03	-	%
Differential Phase ( $f = 3.58MHz$ )	$R_L = 150\Omega$	B	25	-	0.03	-	Degrees
	$R_L = 75\Omega$	B	25	-	0.05	-	Degrees
<b>POWER SUPPLY CHARACTERISTICS</b>							
Power Supply Range		C	25	$\pm 4.5$	-	$\pm 5.5$	V
Power Supply Current (Note 6)		A	25	5.6	5.8	6.1	mA/ Op Amp
		A	Full	5.4	5.9	6.3	mA/ Op Amp

NOTES:

- Test Level: A. Production Tested.; B. Typical or Guaranteed Limit Based on Characterization.; C. Design Typical for Information Only.
- Undershoot dominates for output signal swings below GND (e.g.,  $0.5V_{P-P}$ ), yielding a higher overshoot limit compared to the  $V_{OUT} = 0V$  to  $0.5V$  condition. See the "Application Information" section for details.
- Slew rates are asymmetrical if the output swings below GND (e.g., a bipolar signal). Positive unipolar output signals have symmetric positive and negative slew rates comparable to the +SR specification. See the "Application Information" text, and the pulse response graphs for details.
- See Typical Performance Curves for more information.

**Application Information**

**Optimum Feedback Resistor**

Although a current feedback amplifier's bandwidth dependency on closed loop gain isn't as severe as that of a voltage feedback amplifier, there can be an appreciable decrease in bandwidth at higher gains. This decrease may be minimized by taking advantage of the current feedback amplifier's unique relationship between bandwidth and  $R_F$ . All current feedback amplifiers require a feedback resistor, even for unity gain applications, and  $R_F$ , in conjunction with the internal compensation capacitor, sets the dominant pole of the frequency response. Thus, the amplifier's bandwidth is inversely proportional to  $R_F$ . The HFA1205 design is optimized for a  $464\Omega$   $R_F$  at a gain of +2. Decreasing  $R_F$  decreases stability, resulting in excessive peaking and overshoot (Note: Capacitive feedback will cause the same problems due to the feedback impedance decrease at higher

frequencies). At higher gains the amplifier is more stable, so  $R_F$  can be decreased in a trade-off of stability for bandwidth.

Table 1 lists recommended  $R_F$  values for various gains, and the expected bandwidth. For good channel-to-channel gain matching, it is recommended that all resistors (termination as well as gain setting) be  $\pm 1\%$  tolerance or better. Note that a series input resistor, on +IN, is required for a gain of +1, to reduce gain peaking and increase stability.

**TABLE 1. OPTIMUM FEEDBACK RESISTOR**

GAIN ( $A_{CL}$ )	$R_F$ ( $\Omega$ )	BANDWIDTH (MHz)
-1	332	350
+1	464 ( $+R_S = 432\Omega$ )	300
+2	464	425
+5	215	270
+10	180	115

### Non-inverting Input Source Impedance

For best operation, the DC source impedance seen by the non-inverting input should be  $\geq 50\Omega$ . This is especially important in inverting gain configurations where the non-inverting input would normally be connected directly to GND.

### Pulse Undershoot and Asymmetrical Slew Rates

The HFA1205 utilizes a quasi-complementary output stage to achieve high output current while minimizing quiescent supply current. In this approach, a composite device replaces the traditional PNP pulldown transistor. The composite device switches modes after crossing 0V, resulting in added distortion for signals swinging below ground, and an increased undershoot on the negative portion of the output waveform (see Figures 7, 11, 15 and 19). This undershoot isn't present for small bipolar signals, or large positive signals (see Figures 5, 6, 9, 10, 13, 14, 17 and 18). Another artifact of the composite device is asymmetrical slew rates for output signals with a negative voltage component. The slew rate degrades as the output signal crosses through 0V (see Figures 7, 11, 15, and 19), resulting in a slower overall negative slew rate. Positive only signals have symmetrical slew rates as illustrated in the large signal positive pulse response graphs (see Figures 5, 9, 13 and 17).

### PC Board Layout

The frequency response of this amplifier depends greatly on the amount of care taken in designing the PC board. **The use of low inductance components such as chip resistors and chip capacitors is strongly recommended, while a solid ground plane is a must!**

Attention should be given to decoupling the power supplies. A large value ( $10\mu\text{F}$ ) tantalum in parallel with a small value ( $0.1\mu\text{F}$ ) chip capacitor works well in most cases.

Terminated microstrip signal lines are recommended at the input and output of the device. Capacitance directly on the output must be minimized, or isolated as discussed in the next section.

Care must also be taken to minimize the capacitance to ground at the amplifier's inverting input (-IN). The larger this capacitance, the worse the gain peaking, resulting in pulse overshoot and possible instability. Reduce this capacitance by removing the ground plane under traces connected to -IN, and keep connections to -IN as short as possible.

### Driving Capacitive Loads

Capacitive loads, such as an A/D input, or an improperly terminated transmission line will degrade the amplifier's phase margin resulting in frequency response peaking and possible oscillations. In most cases, the oscillation can be avoided by placing a resistor ( $R_S$ ) in series with the output prior to the capacitance.

Figure 1 details starting points for the selection of this resistor. The points on the curve indicate the  $R_S$  and  $C_L$  combinations for the optimum bandwidth, stability, and settling time, but experimental fine tuning is recommended. Picking a point above or to the right of the curve yields an overdamped response, while points below or left of the curve indicate areas of underdamped performance.

$R_S$  and  $C_L$  form a low pass network at the output, thus limiting system bandwidth well below the amplifier bandwidth of 425MHz (for  $A_V = +2$ ). By decreasing  $R_S$  as  $C_L$  increases (as illustrated in the curves), the maximum bandwidth is obtained without sacrificing stability. In spite of this, bandwidth still decreases as the load capacitance increases. For example, at  $A_V = +2$ ,  $R_S = 50\Omega$ ,  $C_L = 22\text{pF}$ , the overall bandwidth is limited to 230MHz, and bandwidth drops to 80MHz at  $A_V = +2$ ,  $R_S = 7\Omega$ ,  $C_L = 390\text{pF}$ .

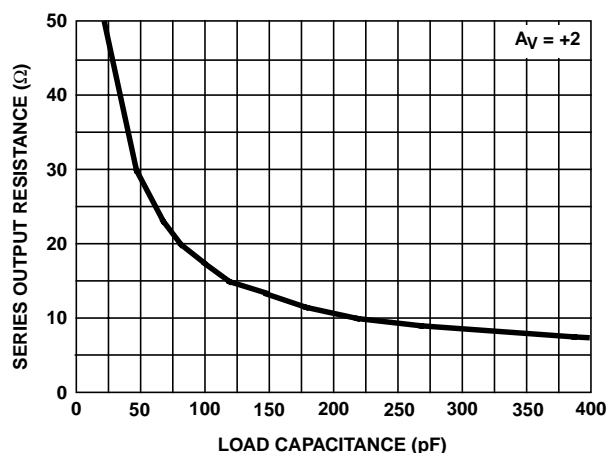

FIGURE 1. RECOMMENDED SERIES OUTPUT RESISTOR vs LOAD CAPACITANCE

### Evaluation Board

The performance of the HFA1205 may be evaluated using the HA5023 Evaluation Board.

The performance of the HFA1205IB (SOIC) may be evaluated using the HA5023 Evaluation Board and a SOIC to DIP adaptor like the Aries Electronics Part Number 08-350000-10.

The schematic for amplifier 1 and the board layout are shown in Figure 2 and Figure 3. Resistors  $R_F$ ,  $R_G$  and  $R_S$  may require a change to the appropriate value (see "Optimum Feedback Resistor" section) for the gain being evaluated.

To order evaluation boards (Part Number HA5023EVAL), please contact your local sales office.

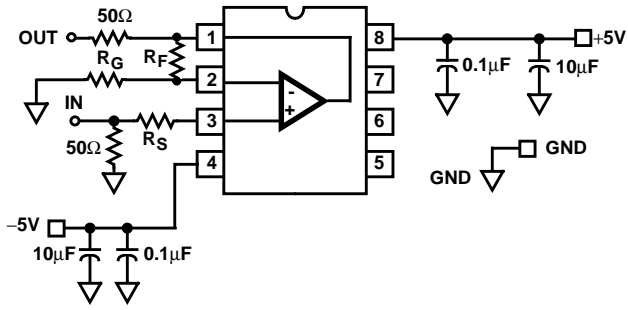

FIGURE 2. MODIFIED EVALUATION BOARD SCHEMATIC

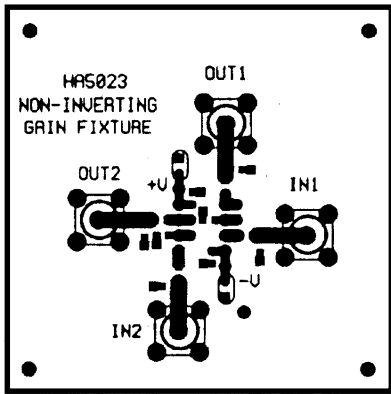

FIGURE 3A. TOP LAYOUT

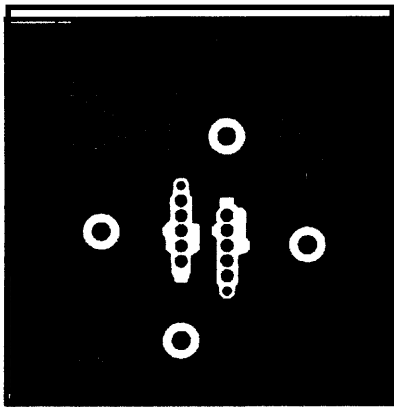

FIGURE 3B. BOTTOM LAYOUT  
FIGURE 3. EVALUATION BOARD LAYOUT

**Typical Performance Curves**  $V_{SUPPLY} = \pm 5V$ ,  $R_F =$  Value From the Optimum Feedback Resistor Table,  $T_A = 25^\circ C$ ,  $R_L = 100\Omega$ ,  
Unless Otherwise Specified

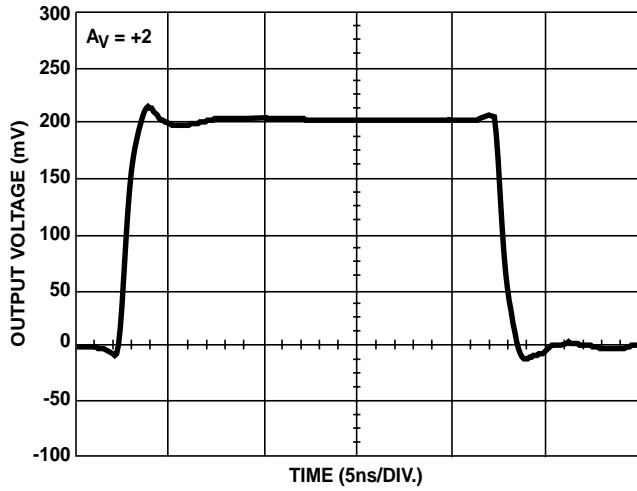

FIGURE 4. SMALL SIGNAL POSITIVE PULSE RESPONSE

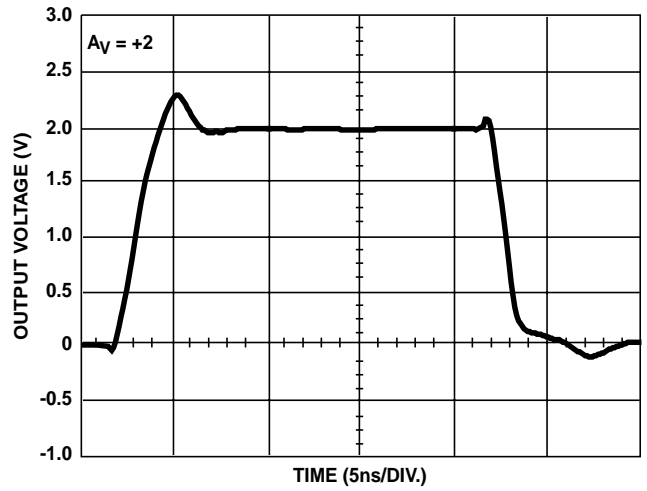

FIGURE 5. LARGE SIGNAL POSITIVE PULSE RESPONSE

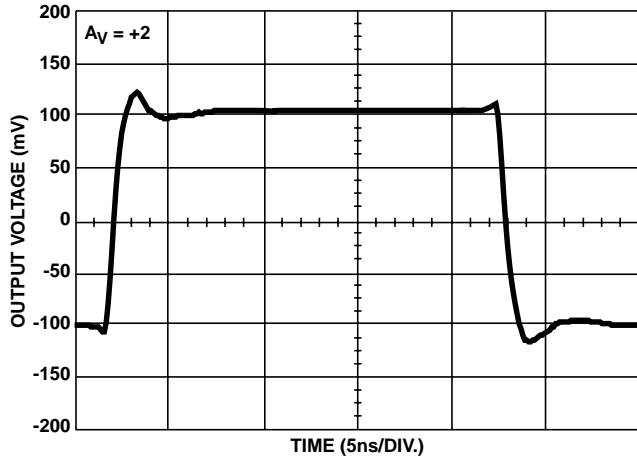

FIGURE 6. SMALL SIGNAL BIPOLAR PULSE RESPONSE

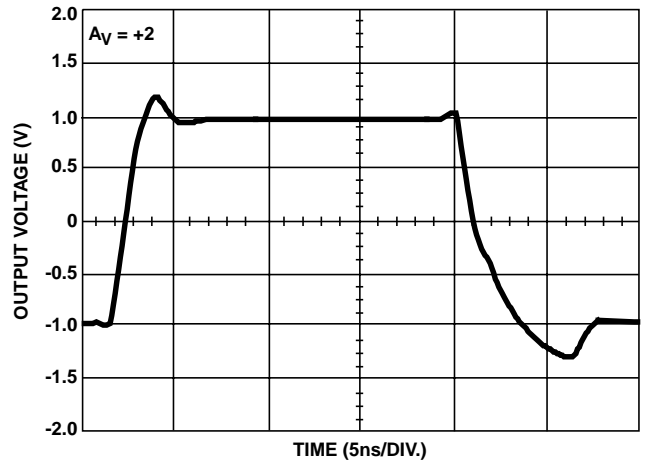

FIGURE 7. LARGE SIGNAL BIPOLAR PULSE RESPONSE

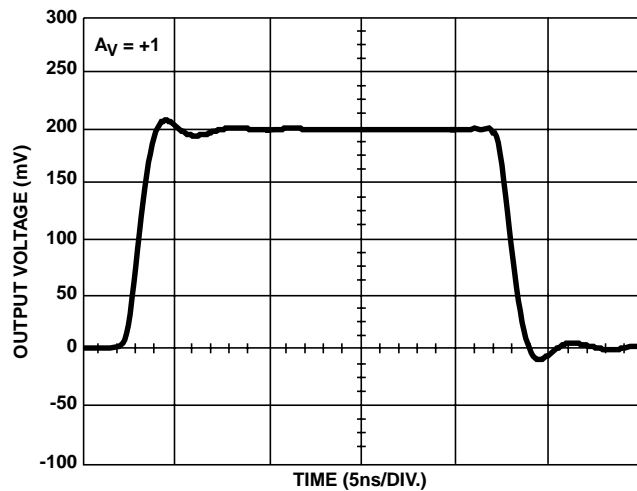

FIGURE 8. SMALL SIGNAL POSITIVE PULSE RESPONSE

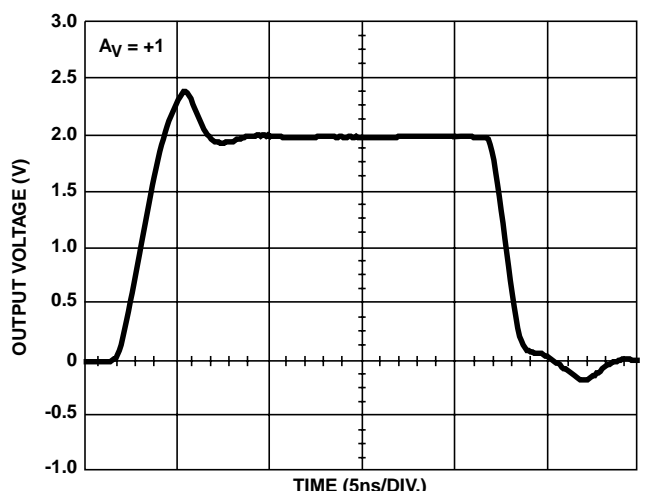

FIGURE 9. LARGE SIGNAL POSITIVE PULSE RESPONSE

**Typical Performance Curves**  $V_{SUPPLY} = \pm 5V$ ,  $R_F =$  Value From the Optimum Feedback Resistor Table,  $T_A = 25^\circ C$ ,  $R_L = 100\Omega$ , Unless Otherwise Specified **(Continued)**

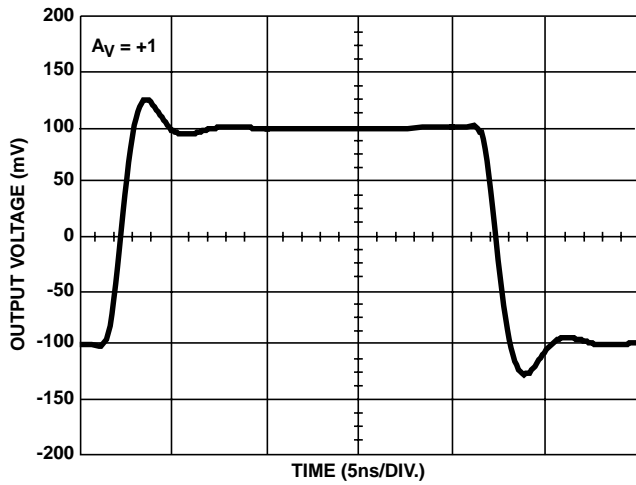

FIGURE 10. SMALL SIGNAL BIPOLAR PULSE RESPONSE

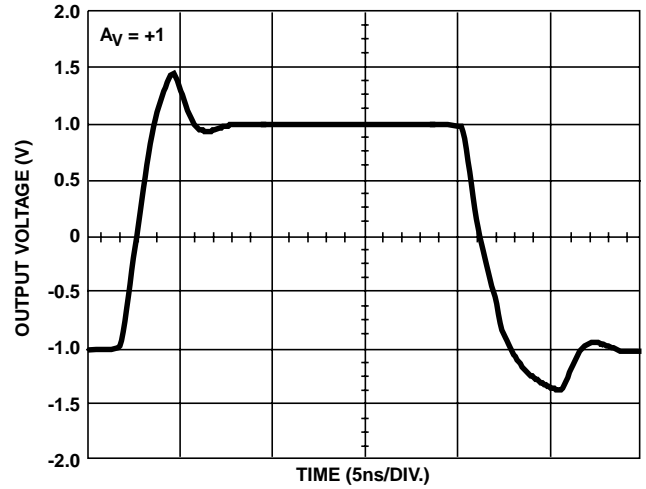

FIGURE 11. LARGE SIGNAL BIPOLAR PULSE RESPONSE

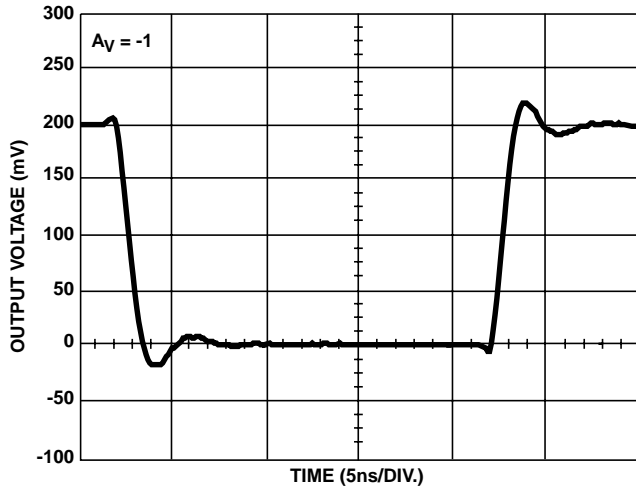

FIGURE 12. SMALL SIGNAL POSITIVE PULSE RESPONSE

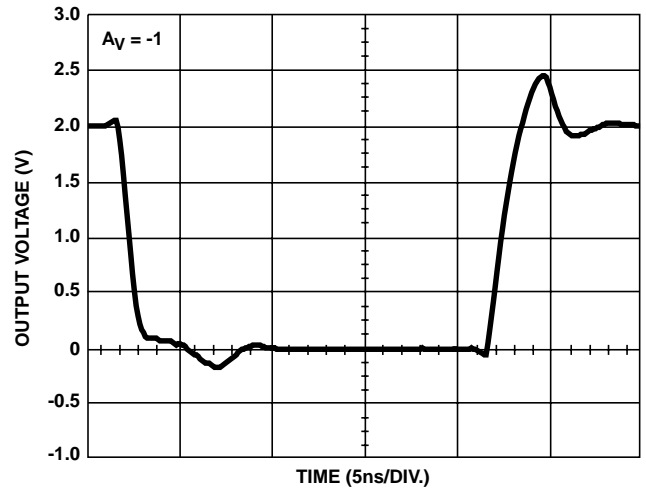

FIGURE 13. LARGE SIGNAL POSITIVE PULSE RESPONSE



**Typical Performance Curves**  $V_{SUPPLY} = \pm 5V$ ,  $R_F =$  Value From the Optimum Feedback Resistor Table,  $T_A = 25^\circ C$ ,  $R_L = 100\Omega$ , Unless Otherwise Specified (Continued)

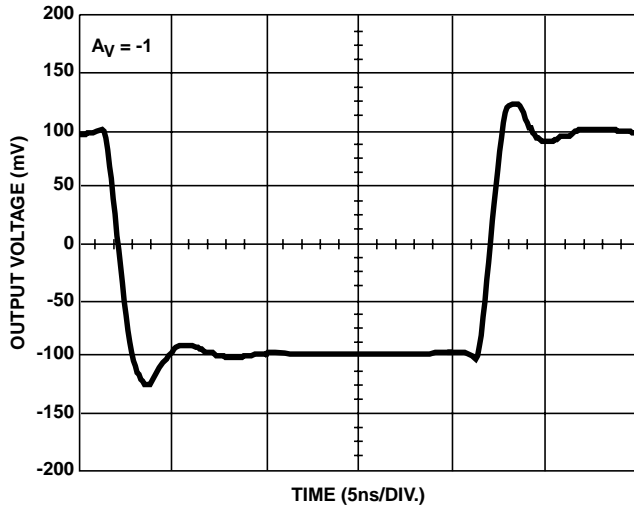

FIGURE 14. SMALL SIGNAL BIPOLAR PULSE RESPONSE

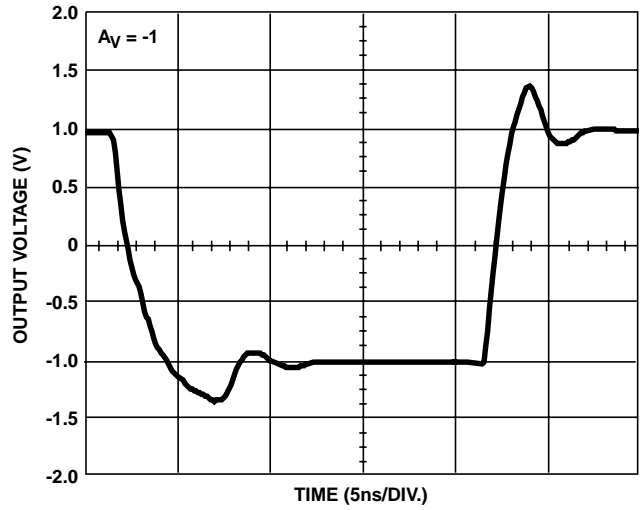

FIGURE 15. LARGE SIGNAL BIPOLAR PULSE RESPONSE

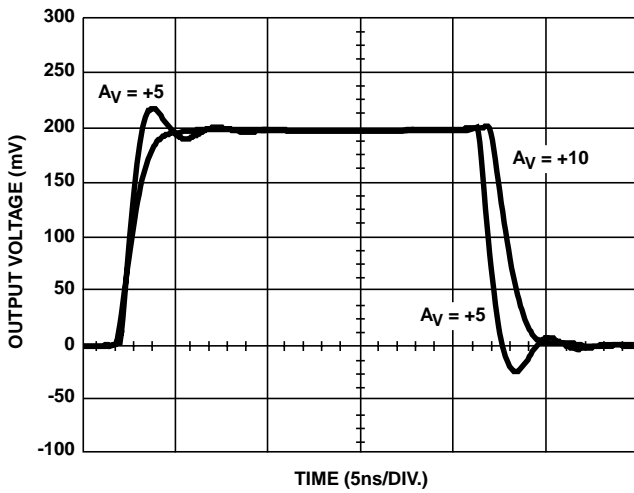

FIGURE 16. SMALL SIGNAL POSITIVE PULSE RESPONSE

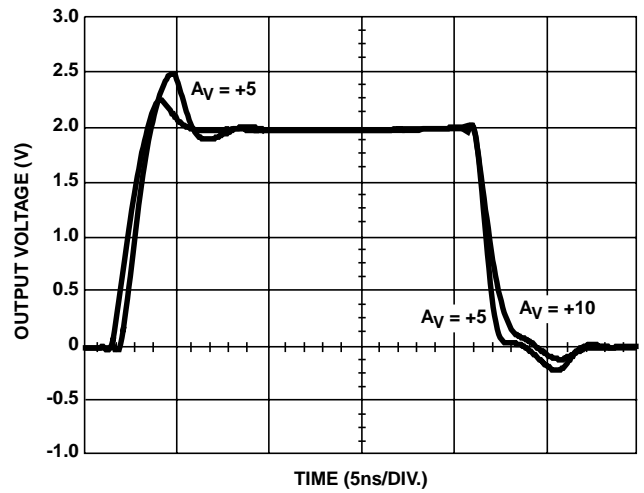

FIGURE 17. LARGE SIGNAL POSITIVE PULSE RESPONSE

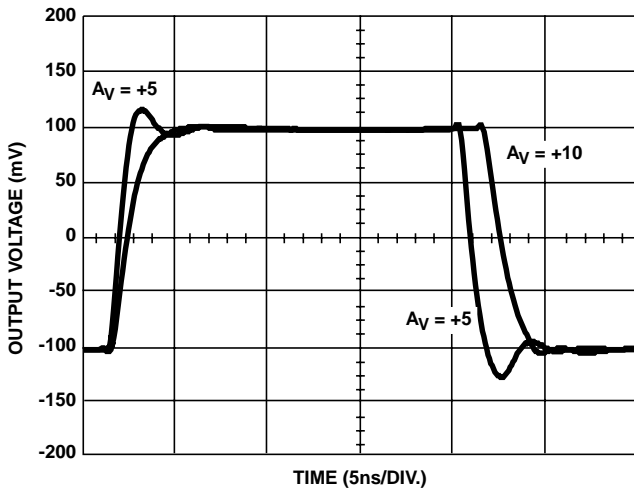

FIGURE 18. SMALL SIGNAL BIPOLAR PULSE RESPONSE

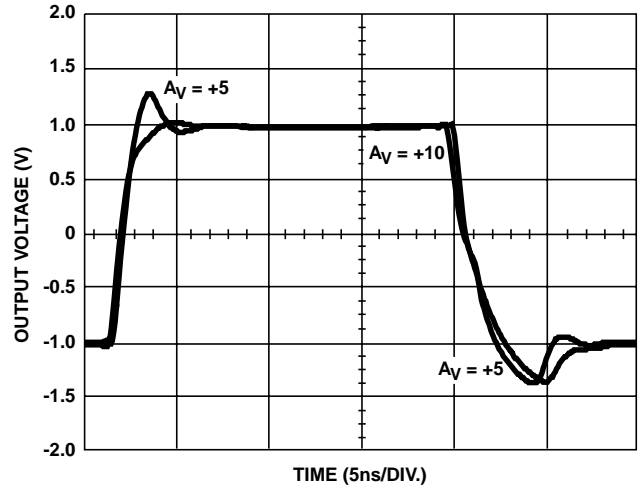

FIGURE 19. LARGE SIGNAL BIPOLAR PULSE RESPONSE

**Typical Performance Curves**  $V_{SUPPLY} = \pm 5V$ ,  $R_F =$  Value From the Optimum Feedback Resistor Table,  $T_A = 25^\circ C$ ,  $R_L = 100\Omega$ , Unless Otherwise Specified (Continued)

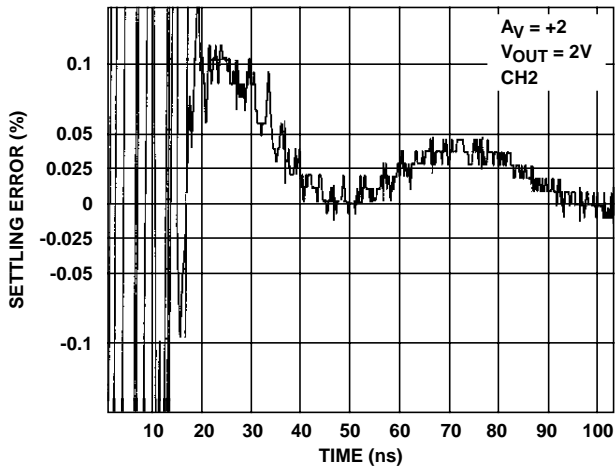

FIGURE 20. SETTLING TIME RESPONSE

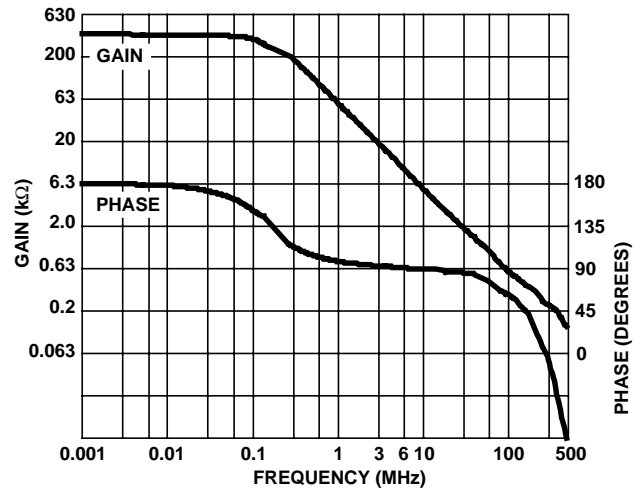

FIGURE 21. OPEN LOOP TRANSIMPEDANCE

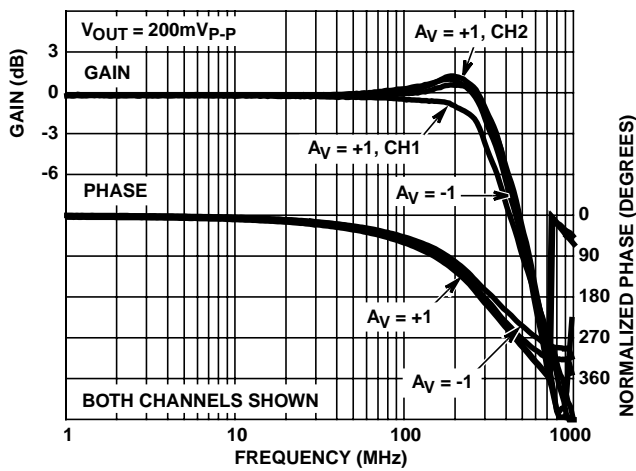

FIGURE 22. FREQUENCY RESPONSE

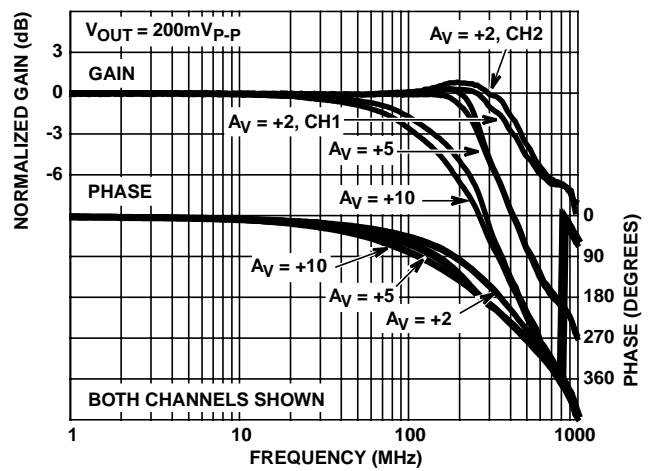

FIGURE 23. FREQUENCY RESPONSE

**Typical Performance Curves**  $V_{SUPPLY} = \pm 5V$ ,  $R_F =$  Value From the Optimum Feedback Resistor Table,  $T_A = 25^\circ C$ ,  $R_L = 100\Omega$ , Unless Otherwise Specified (Continued)

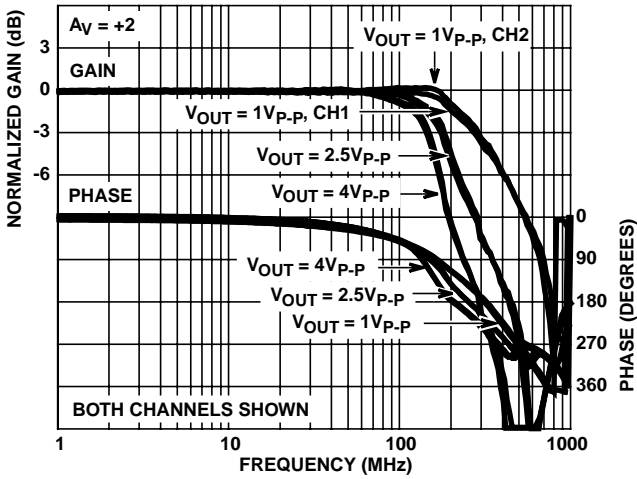

FIGURE 24. FREQUENCY RESPONSE FOR VARIOUS OUTPUT VOLTAGES

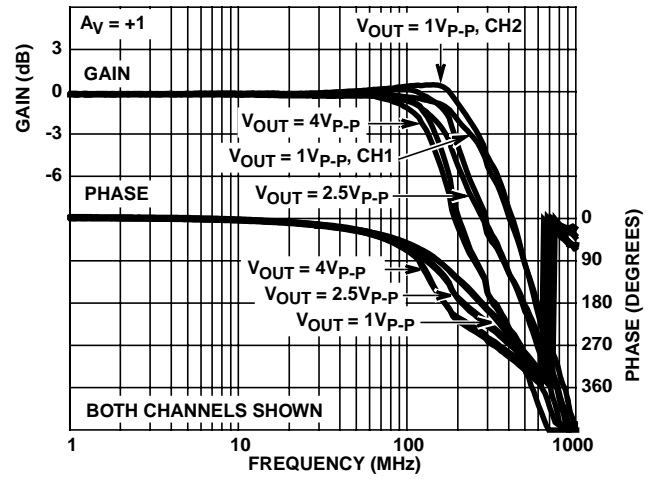

FIGURE 25. FREQUENCY RESPONSE FOR VARIOUS OUTPUT VOLTAGES

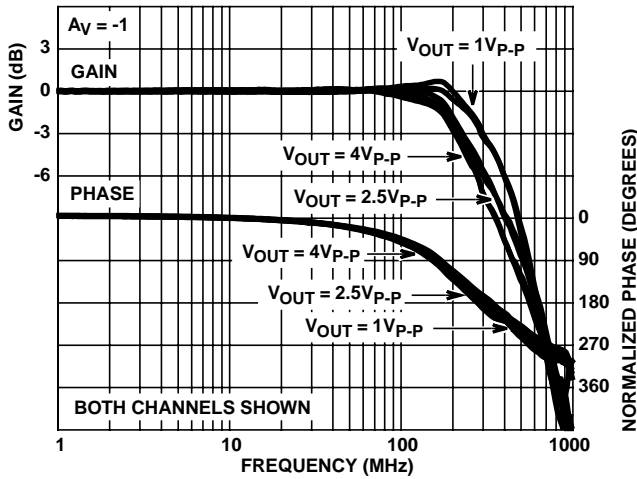

FIGURE 26. FREQUENCY RESPONSE FOR VARIOUS OUTPUT VOLTAGES

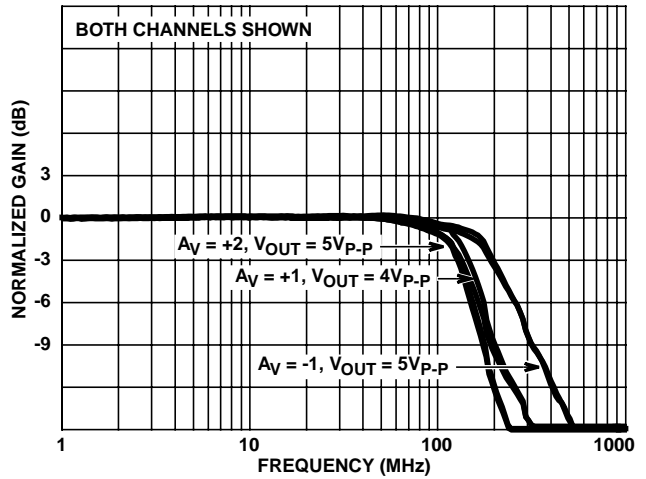

FIGURE 27. FULL POWER BANDWIDTH

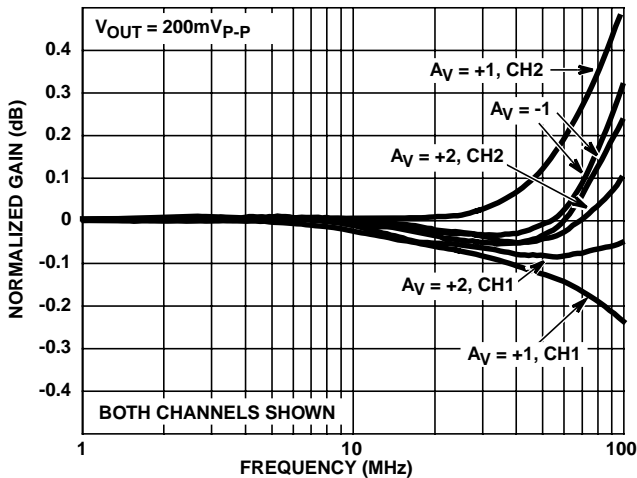

FIGURE 28. GAIN FLATNESS

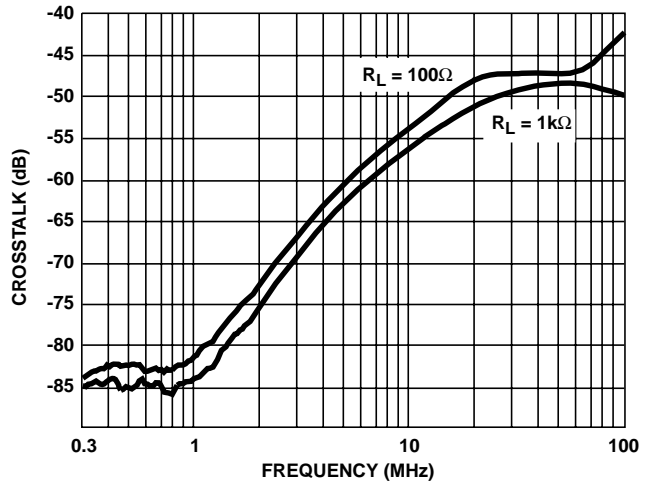

FIGURE 29. CROSSTALK

**Typical Performance Curves**  $V_{SUPPLY} = \pm 5V$ ,  $R_F =$  Value From the Optimum Feedback Resistor Table,  $T_A = 25^\circ C$ ,  $R_L = 100\Omega$ , Unless Otherwise Specified (Continued)

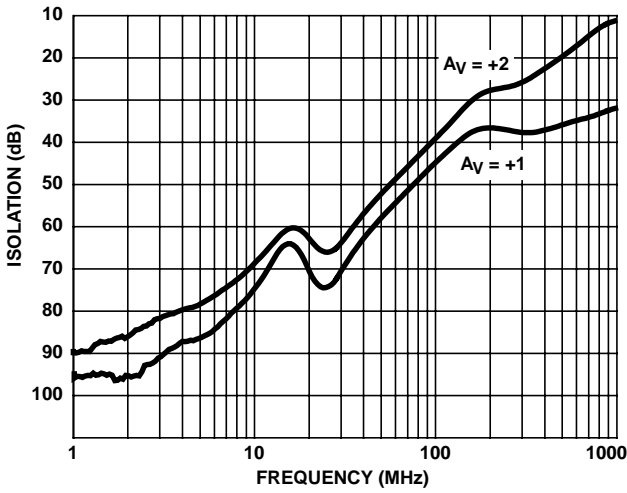

FIGURE 30. REVERSE ISOLATION ( $S_{12}$ )

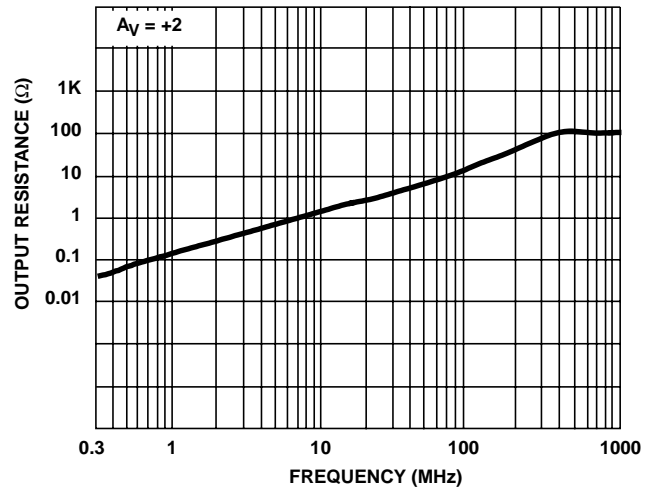

FIGURE 31. OUTPUT RESISTANCE

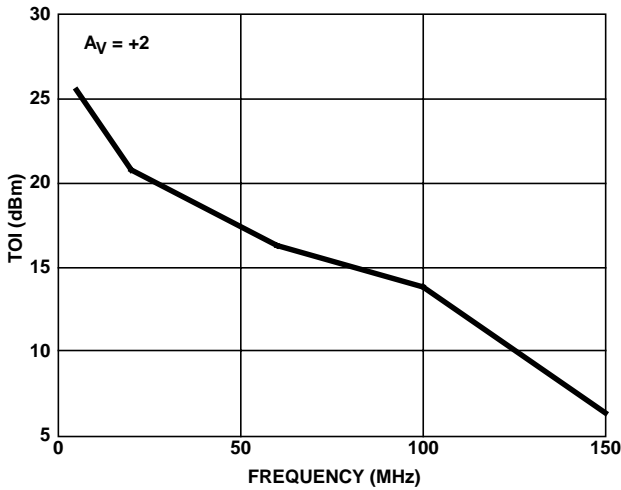

FIGURE 32. 3rd ORDER INTERCEPT vs FREQUENCY

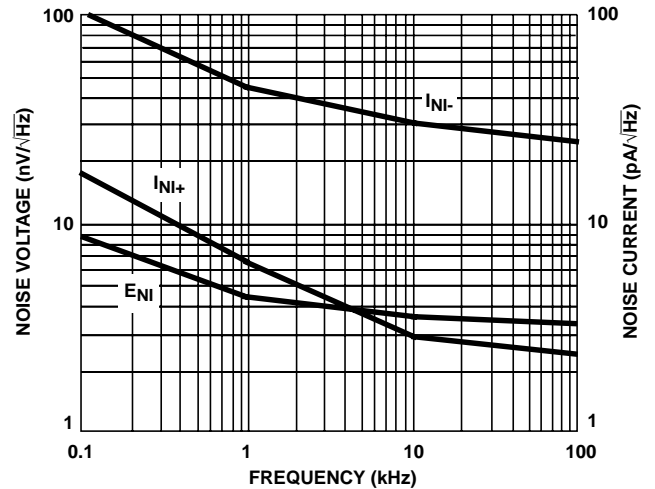

FIGURE 33. INPUT NOISE CHARACTERISTICS

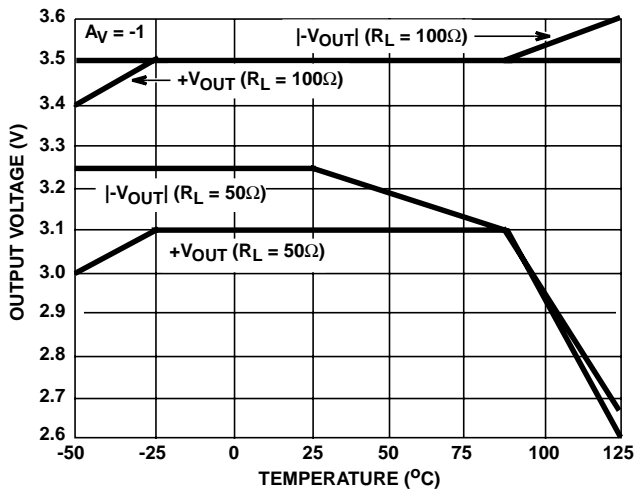

FIGURE 34. OUTPUT VOLTAGE vs TEMPERATURE

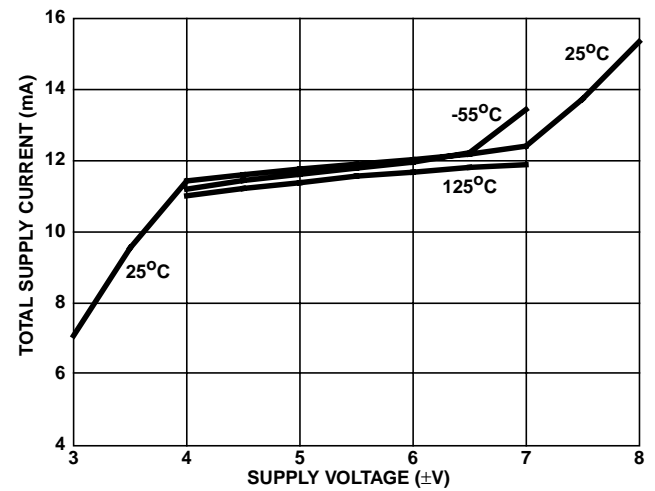

FIGURE 35. SUPPLY CURRENT vs SUPPLY VOLTAGE

**Die Characteristics**

**DIE DIMENSIONS:**

69 mils x 92 mils  
 1750 $\mu$ m x 2330 $\mu$ m

**METALLIZATION:**

Type: Metal 1: AlCu (2%)/TiW  
 Thickness: Metal 1: 8k $\text{Å}$   $\pm$  0.4k $\text{Å}$   
 Type: Metal 2: AlCu (2%)  
 Thickness: Metal 2: 16k $\text{Å}$   $\pm$  0.8k $\text{Å}$

**SUBSTRATE POTENTIAL (POWERED UP):**

Floating (Recommend Connection to V-)

**PASSIVATION:**

Type: Nitride  
 Thickness: 4k $\text{Å}$   $\pm$  0.5k $\text{Å}$

**TRANSISTOR COUNT:**

180

**Metallization Mask Layout**

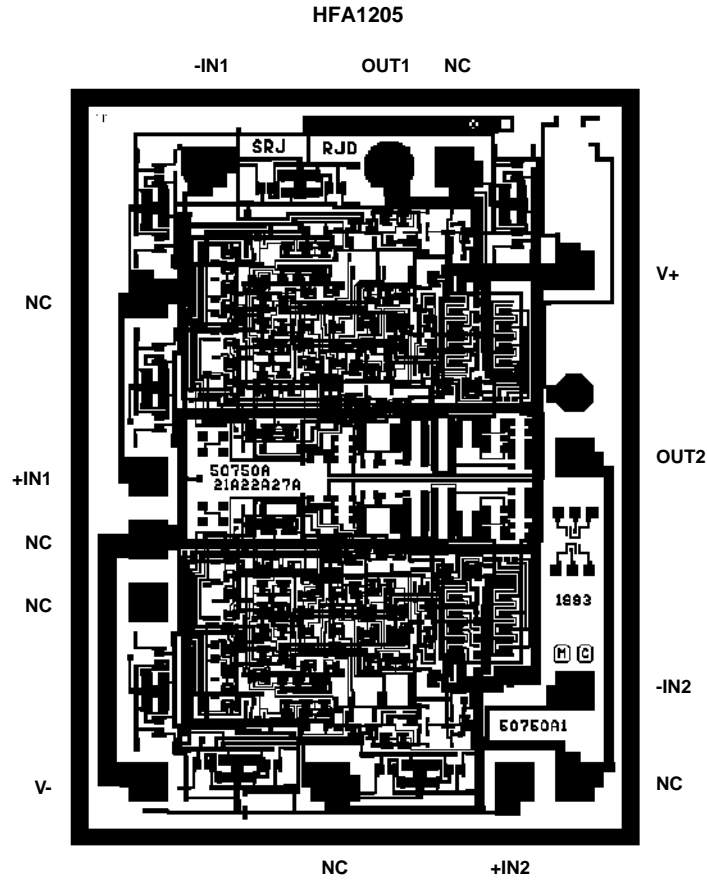

Dual-In-Line Plastic Packages (PDIP)

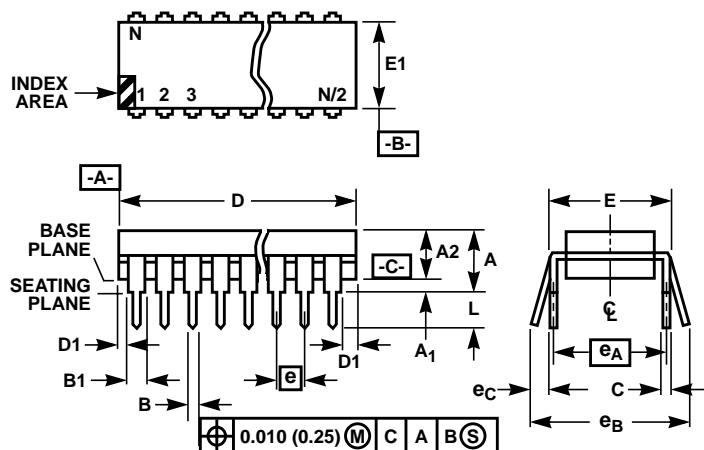

NOTES:

- Controlling Dimensions: INCH. In case of conflict between English and Metric dimensions, the inch dimensions control.
- Dimensioning and tolerancing per ANSI Y14.5M-1982.
- Symbols are defined in the "MO Series Symbol List" in Section 2.2 of Publication No. 95.
- Dimensions A, A1 and L are measured with the package seated in JEDEC seating plane gauge GS-3.
- D, D1, and E1 dimensions do not include mold flash or protrusions. Mold flash or protrusions shall not exceed 0.010 inch (0.25mm).
- E and  $e_A$  are measured with the leads constrained to be perpendicular to datum  $-C-$ .
- $e_B$  and  $e_C$  are measured at the lead tips with the leads unconstrained.  $e_C$  must be zero or greater.
- B1 maximum dimensions do not include dambar protrusions. Dambar protrusions shall not exceed 0.010 inch (0.25mm).
- N is the maximum number of terminal positions.
- Corner leads (1, N, N/2 and N/2 + 1) for E8.3, E16.3, E18.3, E28.3, E42.6 will have a B1 dimension of 0.030 - 0.045 inch (0.76 - 1.14mm).

E8.3 (JEDEC MS-001-BA ISSUE D)  
8 LEAD DUAL-IN-LINE PLASTIC PACKAGE

SYMBOL	INCHES		MILLIMETERS		NOTES
	MIN	MAX	MIN	MAX	
A	-	0.210	-	5.33	4
A1	0.015	-	0.39	-	4
A2	0.115	0.195	2.93	4.95	-
B	0.014	0.022	0.356	0.558	-
B1	0.045	0.070	1.15	1.77	8, 10
C	0.008	0.014	0.204	0.355	-
D	0.355	0.400	9.01	10.16	5
D1	0.005	-	0.13	-	5
E	0.300	0.325	7.62	8.25	6
E1	0.240	0.280	6.10	7.11	5
e	0.100 BSC		2.54 BSC		-
$e_A$	0.300 BSC		7.62 BSC		6
$e_B$	-	0.430	-	10.92	7
L	0.115	0.150	2.93	3.81	4
N	8		8		9

Rev. 0 12/93

**Small Outline Plastic Packages (SOIC)**

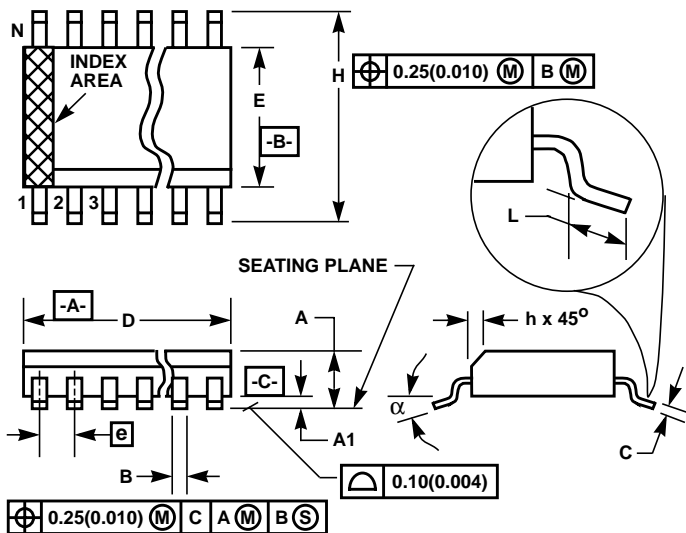

**M8.15 (JEDEC MS-012-AA ISSUE C)**  
**8 LEAD NARROW BODY SMALL OUTLINE PLASTIC PACKAGE**

SYMBOL	INCHES		MILLIMETERS		NOTES
	MIN	MAX	MIN	MAX	
A	0.0532	0.0688	1.35	1.75	-
A1	0.0040	0.0098	0.10	0.25	-
B	0.013	0.020	0.33	0.51	9
C	0.0075	0.0098	0.19	0.25	-
D	0.1890	0.1968	4.80	5.00	3
E	0.1497	0.1574	3.80	4.00	4
e	0.050 BSC		1.27 BSC		-
H	0.2284	0.2440	5.80	6.20	-
h	0.0099	0.0196	0.25	0.50	5
L	0.016	0.050	0.40	1.27	6
N	8		8		7
α	0°	8°	0°	8°	-

**NOTES:**

1. Symbols are defined in the "MO Series Symbol List" in Section 2.2 of Publication Number 95.
2. Dimensioning and tolerancing per ANSI Y14.5M-1982.
3. Dimension "D" does not include mold flash, protrusions or gate burrs. Mold flash, protrusion and gate burrs shall not exceed 0.15mm (0.006 inch) per side.
4. Dimension "E" does not include interlead flash or protrusions. Interlead flash and protrusions shall not exceed 0.25mm (0.010 inch) per side.
5. The chamfer on the body is optional. If it is not present, a visual index feature must be located within the crosshatched area.
6. "L" is the length of terminal for soldering to a substrate.
7. "N" is the number of terminal positions.
8. Terminal numbers are shown for reference only.
9. The lead width "B", as measured 0.36mm (0.014 inch) or greater above the seating plane, shall not exceed a maximum value of 0.61mm (0.024 inch).
10. Controlling dimension: MILLIMETER. Converted inch dimensions are not necessarily exact.

Rev. 0 12/93

All Intersil semiconductor products are manufactured, assembled and tested under **ISO9000** quality systems certification.

*Intersil semiconductor products are sold by description only. Intersil Corporation reserves the right to make changes in circuit design and/or specifications at any time without notice. Accordingly, the reader is cautioned to verify that data sheets are current before placing orders. Information furnished by Intersil is believed to be accurate and reliable. However, no responsibility is assumed by Intersil or its subsidiaries for its use; nor for any infringements of patents or other rights of third parties which may result from its use. No license is granted by implication or otherwise under any patent or patent rights of Intersil or its subsidiaries.*

For information regarding Intersil Corporation and its products, see web site [www.intersil.com](http://www.intersil.com)

**Sales Office Headquarters**

**NORTH AMERICA**  
 Intersil Corporation  
 P. O. Box 883, Mail Stop 53-204  
 Melbourne, FL 32902  
 TEL: (321) 724-7000  
 FAX: (321) 724-7240

**EUROPE**  
 Intersil SA  
 Mercure Center  
 100, Rue de la Fusee  
 1130 Brussels, Belgium  
 TEL: (32) 2.724.2111  
 FAX: (32) 2.724.22.05

**ASIA**  
 Intersil Ltd.  
 8F-2, 96, Sec. 1, Chien-kuo North,  
 Taipei, Taiwan 104  
 Republic of China  
 TEL: 886-2-2515-8508  
 FAX: 886-2-2515-8369