

OBSOLETE PRODUCT
FOR A POSSIBLE SUBSTITUTE PRODUCT
call our Technical Support Center at
1-888-INTERSIL or www.intersil.com/tsc

8-Bit, 250 MSPS, Flash A/D Converter

The HI1166 is an 8-bit, ultra high speed, flash Analog-to-Digital converter IC capable of digitizing analog signals at a maximum rate of 250 MSPS. The digital I/O levels of the converter are compatible with ECL 100K/10KH/10K.

Applications

- Spectrum Analyzers
- Radar Systems
- Direct RF Down-Conversion
- Video Digitizing
- Communication Systems
- Digital Oscilloscopes

Part Number Information

PART NUMBER	TEMP. RANGE (°C)	PACKAGE	PKG. NO.
HI1166AIL	-20 to 100	68 Ld CLCC	J68.A
HI1166-EV	25	Evaluation Board	

Features

- Differential Linearity Error ±0.5 LSB or Less
- Integral Linearity Error ±0.5 LSB or Less
- Built-In Integral Linearity Compensation Circuit
- Ultra High Speed Operation with Maximum Conversion Rate (Min) 250 MSPS
- Low Input Capacitance 18pF (Typ)
- Wide Analog Input Bandwidth (Min for Full Scale Input) 250MHz
- Single Power Supply -5.2V
- Low Power Consumption 1.4W (Typ)
- Low Error Rate
- Capable of Driving 50Ω Loads
- Evaluation Board Available
- Direct Replacement for Sony CXA1166K

Pinout

HI1166 (CLCC) TOP VIEW

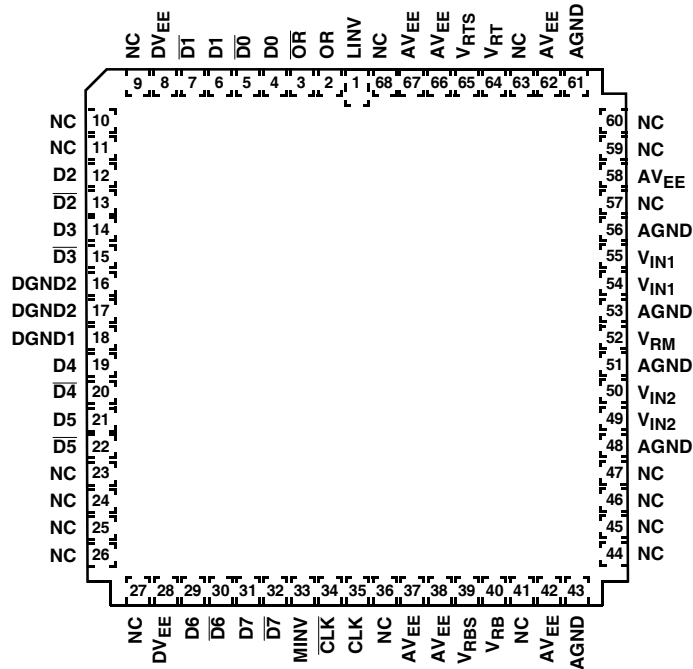

Functional Block Diagram

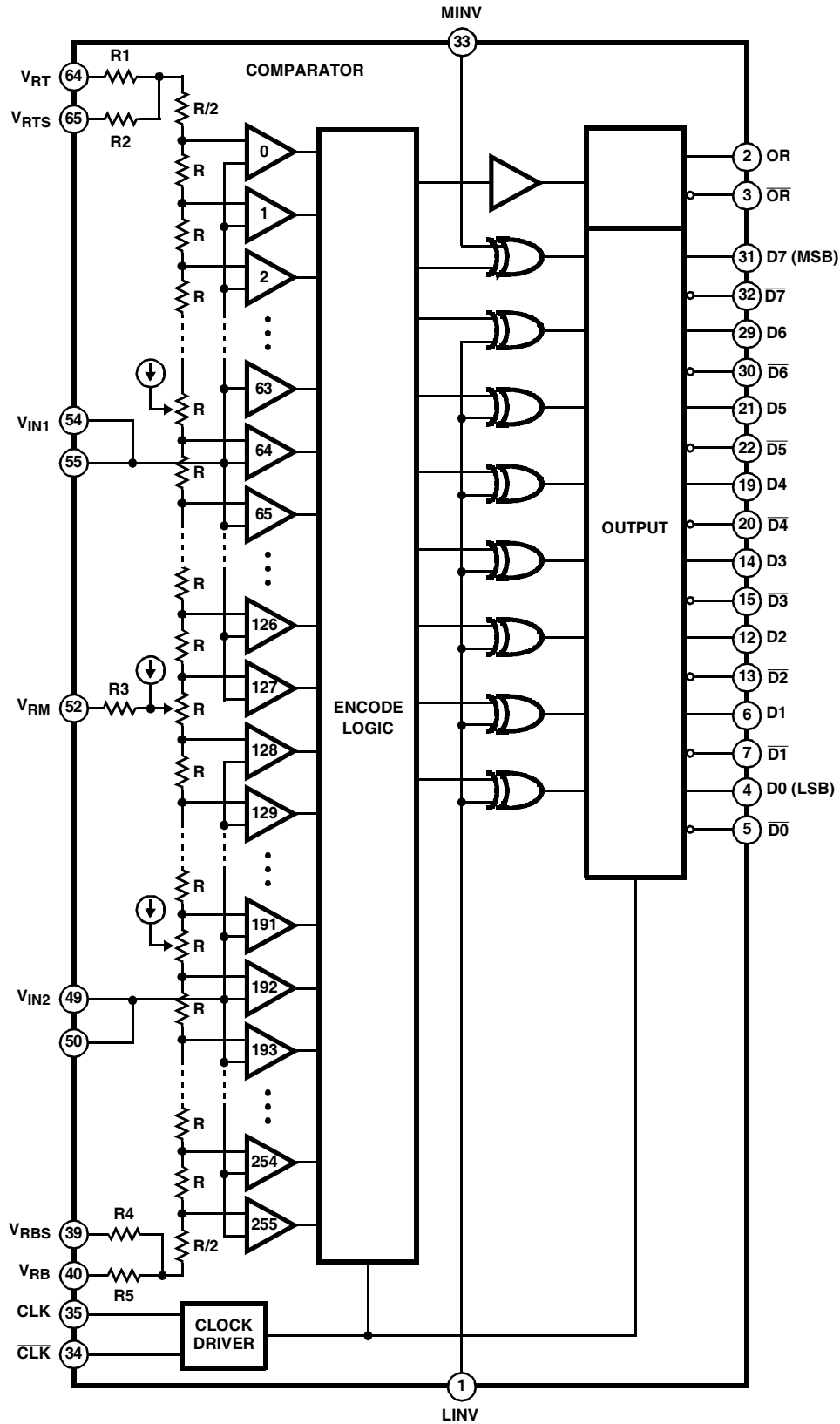

Absolute Maximum Ratings $T_A = 25^{\circ}\text{C}$

Supply Voltage (V_{EE}, DV_{EE})	-7V to +0.5V
Analog Input Voltage (V_{IN})	-2.7V to +0.5V
Reference Input Voltage	
V_{RT}, V_{RB}, V_{RM}	-2.7V to +0.5V
$ V_{RT} - V_{RB} $	2.5V
Digital Input Voltage	
$MINV, LINV, CLK, \overline{CLK}$	-4V to +0.5V
$ \overline{CLK} - CLK $	2.7V
V_{RM} Pin Input Current (I_{VRM})	-3mA to +3mA
Digital Output Current	
($ID0$ to $ID7, IOR, \overline{ID0}$ to $\overline{ID7}, \overline{IOR}$)	-30mA to 0mA
Temperature Range, T_A (Note 5)	-20°C to 100°C
T_C	-20°C to 125°C

Thermal Information

Thermal Resistance (Typical, Note 2)	$\theta_{JA}^{\circ}\text{C/W}$	$\theta_{JC}^{\circ}\text{C/W}$
CLCC Package	38	10
Maximum Power Dissipation	2.1W	
Maximum Junction Temperature	175°C	
Maximum Storage Temperature Range (T_{STG})	-65°C to 150°C	
Maximum Lead Temperature (Soldering, 10s)	300°C	

Operating Conditions (Note 1)

Supply Voltage	MIN	TYP	MAX	Reference Input Voltage	MIN	TYP	MAX
V_{EE}, DV_{EE}	-5.5V	-5.2	-4.95V	V_{RT}	-0.1V	-2	0.1V
$V_{EE} - DV_{EE}$	-0.05V	0	0.05V	V_{RB}	-2.2V	-2	-1.8V
AGND - DGND	-0.05V	0	0.05V	Analog Input Voltage, V_{IN}	V_{RB} to V_{RT}		

CAUTION: Stresses above those listed in "Absolute Maximum Ratings" may cause permanent damage to the device. This is a stress only rating and operation of the device at these or any other conditions above those indicated in the operational sections of this specification is not implied.

NOTES:

- Electrical Specifications guaranteed within stated operating conditions.
- θ_{JA} is measured with the component mounted on an evaluation PC board in free air.

Electrical Specifications $T_A = 25^{\circ}\text{C}, V_{EE} = DV_{EE} = -5.2\text{V}, V_{RT}, V_{RTS} = 0\text{V}, V_{RB}, V_{RBS} = -2\text{V}$ (Note 1)

PARAMETER	TEST CONDITIONS	MIN	TYP	MAX	UNIT
SYSTEM PERFORMANCE					
Resolution		-	8	-	Bits
Integral Linearity Error, INL	$f_C = 250$ MSPS	-	± 0.3	± 0.5	LSB
Differential Linearity Error, DNL	$f_C = 250$ MSPS	-	± 0.3	± 0.5	LSB
DYNAMIC CHARACTERISTICS					
Signal to Noise Ratio, SINAD	Input = 1kHz, Full Scale $f_C = 250\text{MHz}$	44	46	-	dB
$= \frac{\text{RMS Signal}}{\text{RMS Noise} + \text{Distortion}}$	Input = 60kHz, Full Scale $f_C = 250\text{MHz}$	-	37	-	dB
Error Rate	Input = 50MHz, Full Scale Error > 16 LSB, $f_C = 250\text{MHz}$	-	-	10^{-9}	TPS (Note 3)
	Input = 62.499MHz, Full Scale Error > 16 LSB, $f_C = 250\text{MHz}$	-	10^{-8}	10^{-6}	TPS (Note 3)
Differential Gain Error, DG	NTSC 40 IRE Mod.	-	1.0	-	%
Differential Phase Error, DP	Ramp, $f_C = 250$ MSPS	-	0.5	-	Degree
Overrange Recovery Time		-	1.0	-	ns
Maximum Conversion Rate, f_C		250	-	-	MSPS
Aperture Jitter, t_{AJ}		-	9	-	ps
Sampling Delay, t_{DS}		0.4	1.4	2.4	ns
ANALOG INPUT					
Analog Input Capacitance, C_{IN}	$V_{IN} - 1\text{V} + 0.07V_{RMS}$	-	18	-	pF
Analog Input Resistance, R_{IN}		50	120	-	k Ω
Input Bias Current, I_{IN}	$V_{IN} = -1\text{V}$	20	-	450	μA
Full Scale Input Bandwidth	$V_{IN} = 2V_{P-P}$	200	250	-	MHz
REFERENCE INPUTS					
Reference Resistance, R_{REF}		83	125	182	Ω

Electrical Specifications $T_A = 25^{\circ}\text{C}$, $AV_{EE} = DV_{EE} = -5.2\text{V}$, V_{RT} , $V_{RTS} = 0\text{V}$, V_{RB} , $V_{RBS} = -2\text{V}$ (Note 1) (Continued)

PARAMETER		TEST CONDITIONS	MIN	TYP	MAX	UNIT
Residual Resistance	R1	Note 2	0.1	0.6	2.0	Ω
	R2		300	500	700	Ω
	R3		0.5	2.0	5.0	Ω
	R4		300	500	700	Ω
	R5		0.1	0.6	2.0	Ω
DIGITAL INPUTS						
Logic H Level, V_{IH}			-1.13	-	-	V
Logic L Level, V_{IL}			-	-	-1.5	V
Logic H Current, I_{IH}		Input Connected to GND	0	-	70	μA
Logic L Current, I_{IL}		Input Connected to -2V	-50	-	50	μA
Input Capacitance			-	4	-	pF
DIGITAL OUTPUTS						
Logic H Level, V_{OH}		$R_L = 50\Omega$	-1.0	-	-	V
Logic L Level, V_{OL}		$R_L = 50\Omega$	-	-	-1.6	V
TIMING CHARACTERISTICS						
H Pulse Width of Clock, t_{PW1}			1.8	-	-	ns
L Pulse Width of Clock, t_{PW0}			1.8	-	-	ns
Output Rise Time, t_r		$R_L = 50\Omega$	-	0.6	1.5	ns
Output Fall Time, t_f		$R_L = 50\Omega$	-	0.6	1.5	ns
Output Delay, t_{OD}		$R_L = 50\Omega$	1.8	2.5	3.2	ns
POWER SUPPLY CHARACTERISTICS						
Supply Current, I_{EE}			-360	-270	-	mA
Power Consumption, P_D		Note 4	-	1.4	1.9	W

NOTES:

1. Electrical Specifications guaranteed within stated operating conditions.
2. See Functional Block Diagram.
3. TPS: Times Per Sample.
4. $P_D = I_{EEA} \cdot AV_{EE} + I_{EED} \cdot DV_{EE} + \frac{(V_{RT} - V_{RB})^2}{R_{REF}}$
5. T_A is specified in still air and without heat sink. To extend temperature range, appropriate heat management techniques must be employed (See Figure 2).

Timing Diagram

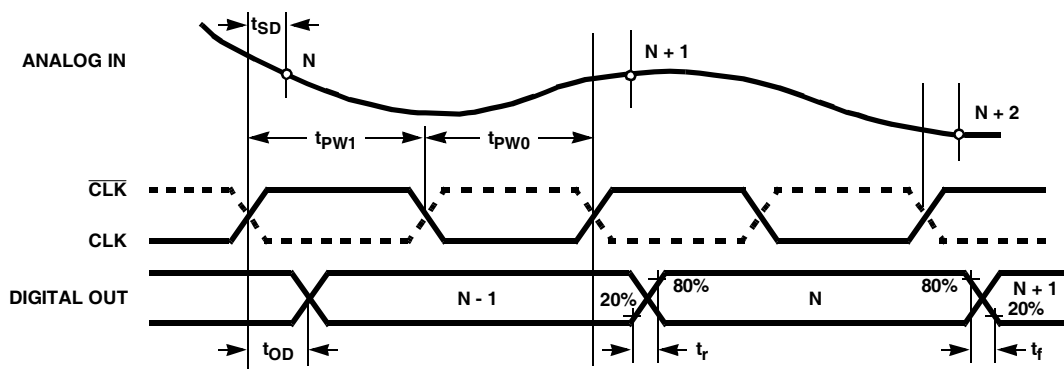

FIGURE 1.

Typical Performance Curves

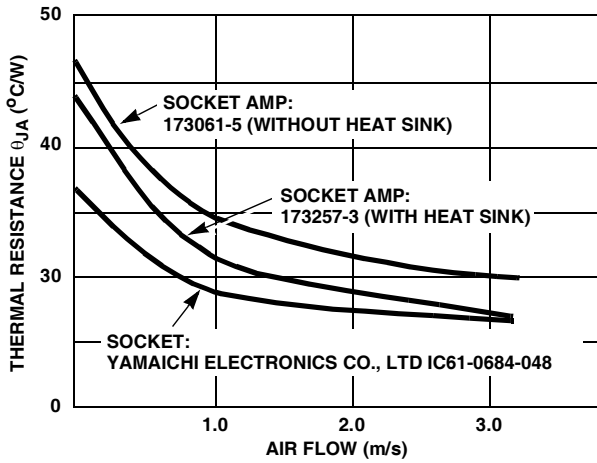

FIGURE 2. THERMAL RESISTANCE OF THE CONVERTER MOUNTED ON A BOARD

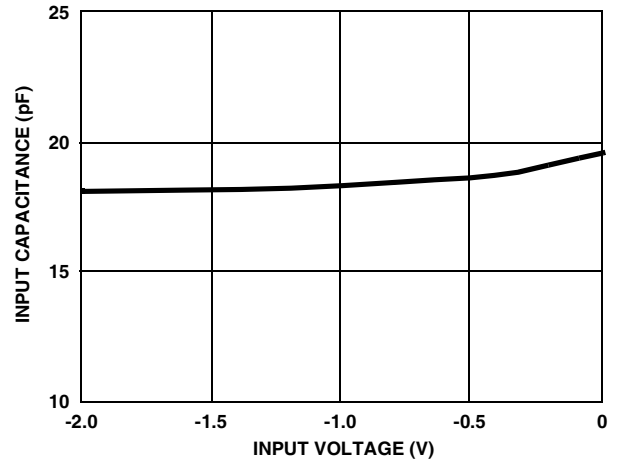

FIGURE 3. V_{IN} PIN CAPACITANCE vs VOLTAGE CHARACTERISTICS

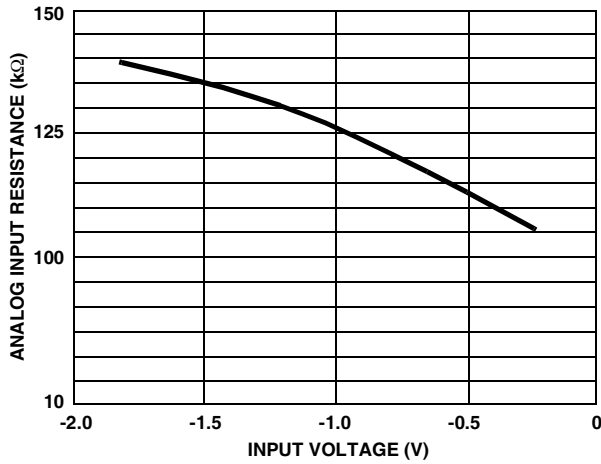

FIGURE 4. V_{IN} PIN INPUT RESISTANCE vs VOLTAGE CHARACTERISTICS

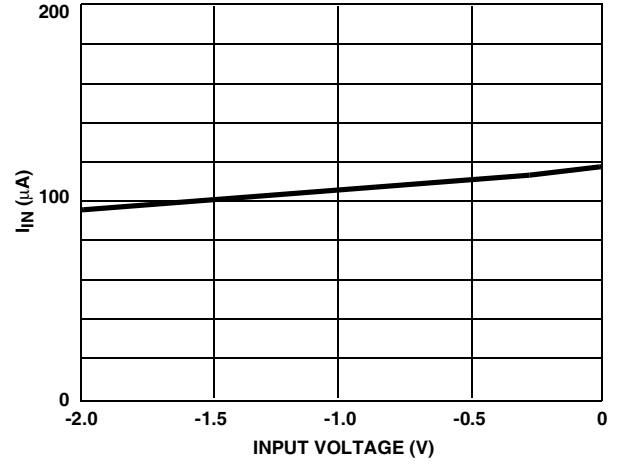

FIGURE 5. V_{IN} PIN INPUT CURRENT vs VOLTAGE CHARACTERISTICS

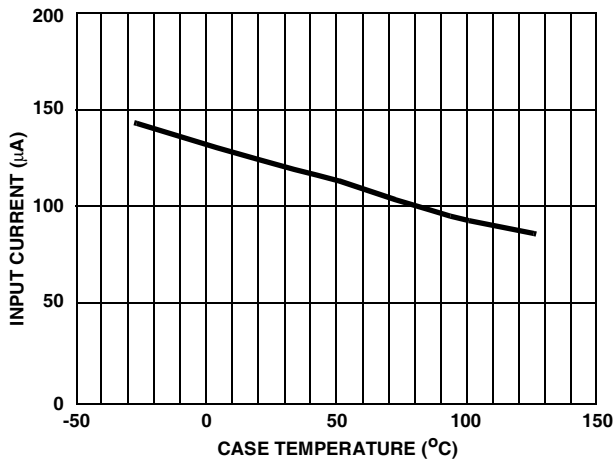

FIGURE 6. V_{IN} PIN INPUT CURRENT vs TEMPERATURE CHARACTERISTICS

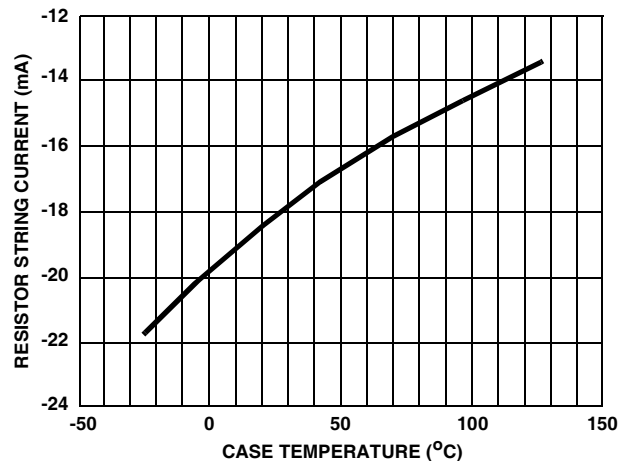

FIGURE 7. RESISTOR STRING CURRENT vs TEMPERATURE CHARACTERISTICS

Typical Performance Curves (Continued)

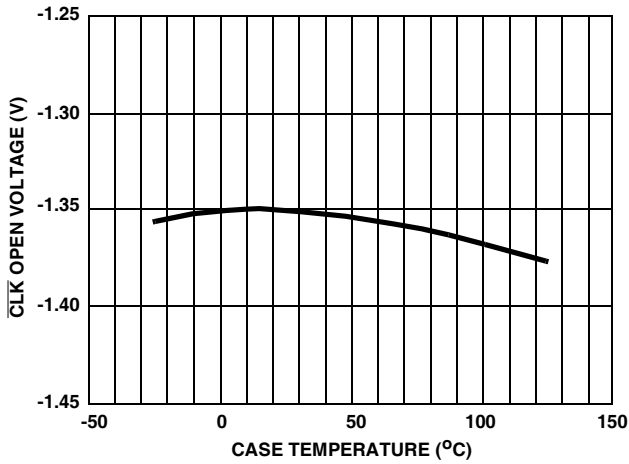

FIGURE 8. $\overline{\text{CLK}}$ OPEN VOLTAGE vs TEMPERATURE CHARACTERISTICS

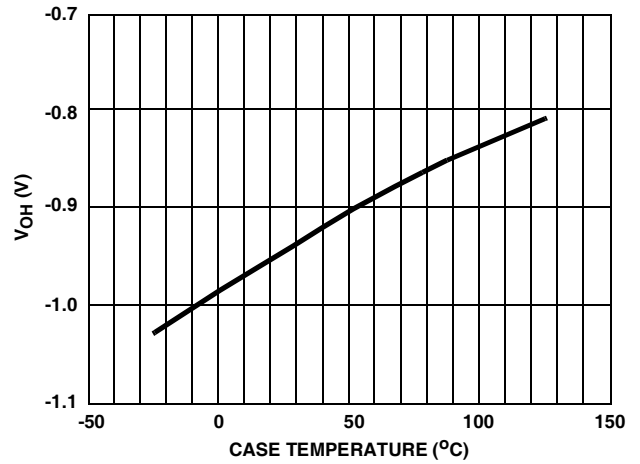

FIGURE 9. V_{OH} vs TEMPERATURE CHARACTERISTICS

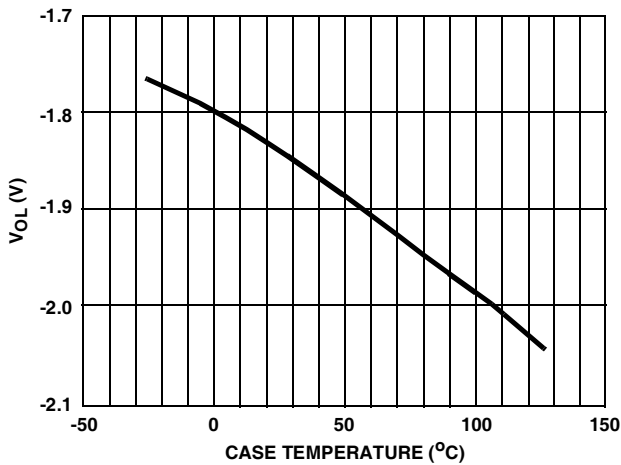

FIGURE 10. V_{OL} vs TEMPERATURE CHARACTERISTICS

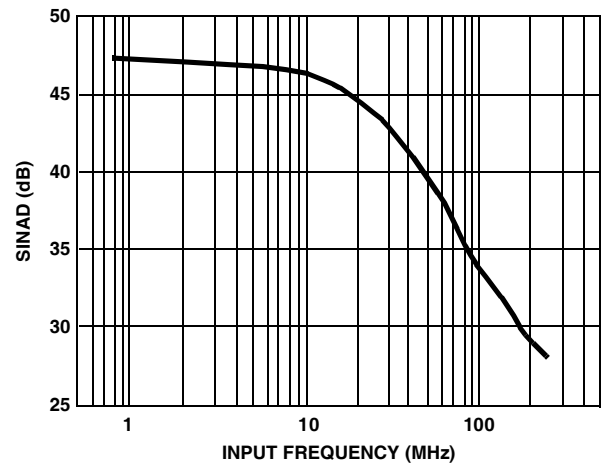

FIGURE 11. SINAD vs INPUT FREQUENCY RESPONSE CHARACTERISTICS

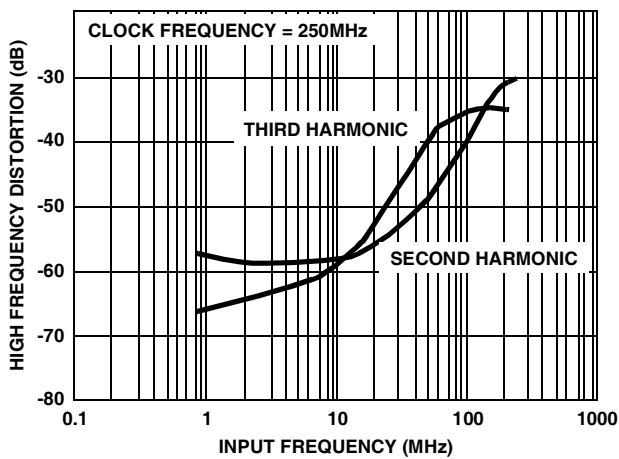

FIGURE 12. HARMONIC DISTORTION vs INPUT FREQUENCY RESPONSE CHARACTERISTICS

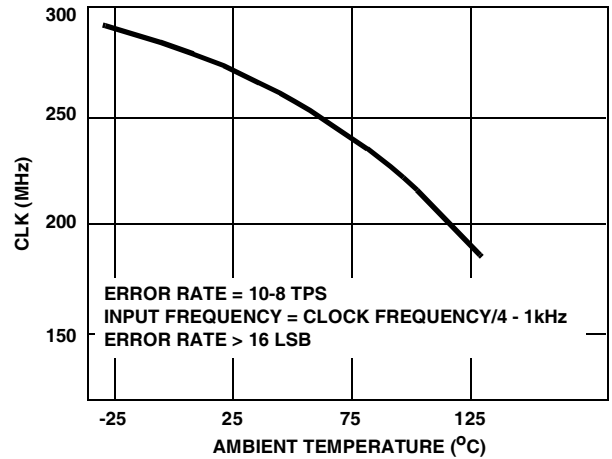

FIGURE 13. MAXIMUM CONVERSION RATE vs TEMPERATURE CHARACTERISTICS

Typical Performance Curves (Continued)

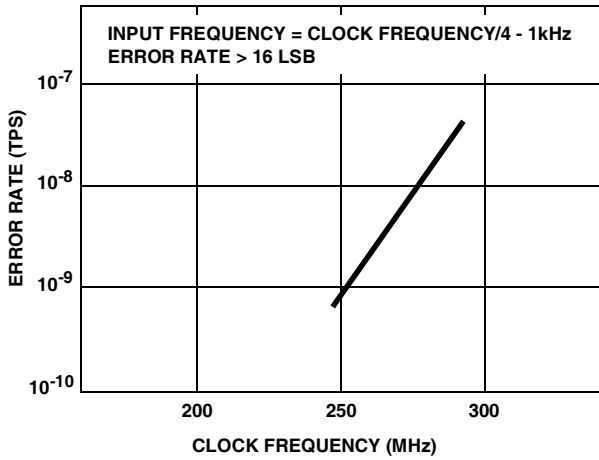

FIGURE 14. ERROR RATE vs CONVERSION RATE

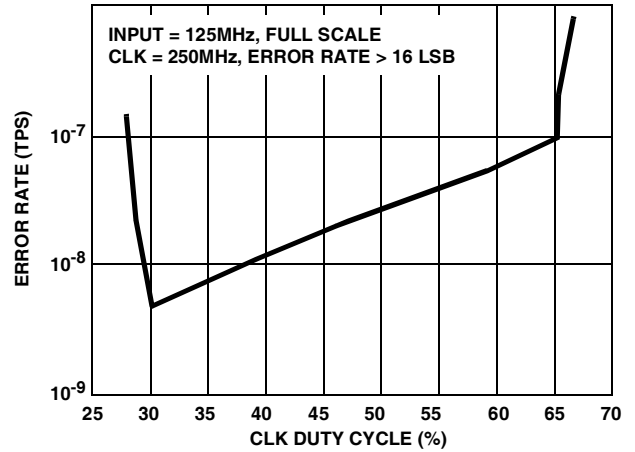

FIGURE 15. ERROR RATE vs CLOCK DUTY CYCLE

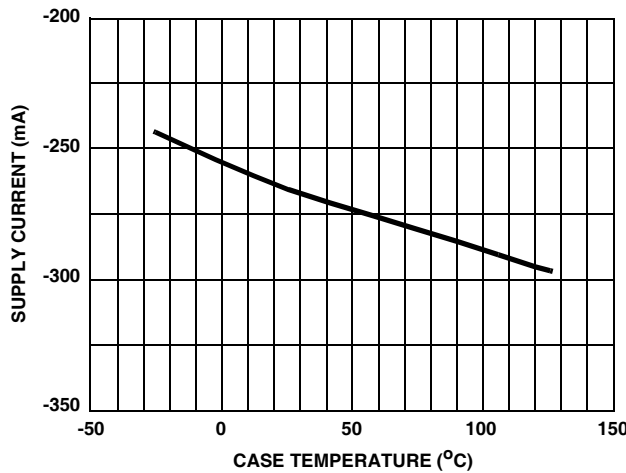

FIGURE 16. SUPPLY CURRENT vs TEMPERATURE CHARACTERISTICS

Pin Descriptions

PIN NUMBER	SYMBOL	I/O	STANDARD VOLTAGE LEVEL	EQUIVALENT CIRCUIT	DESCRIPTION
4, 5	D0, $\overline{D0}$	O	ECL		LSB and complementary LSB output.
6, 7	D1, $\overline{D1}$				D1 to D6: Data Output. $\overline{D1}$ to $\overline{D6}$: Complementary Data Output.
12, 13	D2, $\overline{D2}$				
14, 15	D3, $\overline{D3}$				
19, 20	D4, $\overline{D4}$				
21, 22	D5, $\overline{D5}$				
29, 30	D6, $\overline{D6}$				
31, 32	D7, $\overline{D7}$	MSB Complementary MSB Data Output.			
2, 3	OR, \overline{OR}	Overrange and Complementary Overrange Output.			

Pin Descriptions (Continued)

PIN NUMBER	SYMBOL	I/O	STANDARD VOLTAGE LEVEL	EQUIVALENT CIRCUIT	DESCRIPTION
1	LINV	I	ECL		<p>Polarity selection for LSBs (refer to the A/D Output Code Table.) Pulled low when left open.</p> <p>Polarity selection for MSB (refer to the A/D Output Code Table). Pulled low when left open.</p>
33	MINV	I	ECL		
35	CLK	I	ECL		<p>CLK Input.</p> <p>Complementary CLK Input. Pulled down to -1.3V when left open.</p>
34	CLK	I	ECL		
64	V _{RT}	I	0V		<p>Analog Reference Voltage (Top) (0V Typ).</p>
65	V _{RTS}	O	0V		<p>Reference Voltage Sense (Top).</p>
52	V _{RM}	I	V _{RB} /2		<p>Reference Voltage Mid Point. Can be used for linearity compensation.</p>
39	V _{RBS}	O	-2V		<p>Reference Voltage Sense (Bottom).</p>
40	V _{RB}	I	-2V		<p>Analog Reference Voltage (Bottom).</p>

Pin Descriptions (Continued)

PIN NUMBER	SYMBOL	I/O	STANDARD VOLTAGE LEVEL	EQUIVALENT CIRCUIT	DESCRIPTION
49, 50	V_{IN2}	I	V_{RTS} to V_{RBS}		Analog Input. All of the pins must be wired externally.
54, 55	V_{IN1}				
43, 48, 51, 53, 56, 61	AGND		0V		Analog ground.
37, 38, 42, 58, 62, 66, 67	AV_{EE}		-5.2V		Analog supply. Internally connected to DV_{EE} (resistance: 4Ω to 6Ω).
18	DGND1		0V		Digital ground.
16, 17	DGND2		0V		Digital ground for output drive.
8, 28	DV_{EE}		-5.2V		Digital supply. Internally connected to AV_{EE} (resistance: 4Ω to 6Ω).

TABLE 1. A/D OUTPUT CODE

V_{IN} (NOTE 6)	STEP	MINV 1, LINV 1			0, 1			1, 0			0, 0			
		OR	D7	D0	OR	D7	D0	OR	D7	D0	OR	D0	D7	
0V	0	0	000	•••••	00	0	100	•••••	00	0	011	•••••	11	
		1	000	•••••	00	1	100	•••••	00	1	011	•••••	11	
		1	000	•••••	01	1	100	•••••	01	1	011	•••••	10	
-1V	127	1	011	•••••	11	1	111	•••••	11	1	000	•••••	00	
		128	1	100	•••••	00	1	000	•••••	00	1	111	•••••	11
		•	•	•	•	•	•	•	•	•	•	•	•	•
		•	•	•	•	•	•	•	•	•	•	•	•	•
		•	•	•	•	•	•	•	•	•	•	•	•	•
-2V	254	1	111	•••••	10	1	011	•••••	10	1	100	•••••	01	
	255	1	111	•••••	11	1	011	•••••	11	1	100	•••••	00	
-2V	•	1	111	•••••	11	1	011	•••••	11	1	100	•••••	00	

NOTE:

6. $V_{RT} = V_{RTS} = 0V$, $V_{RM} = -1V$ or open, $V_{RB} = V_{RBS} = -2V$.

Test Circuits and Waveforms

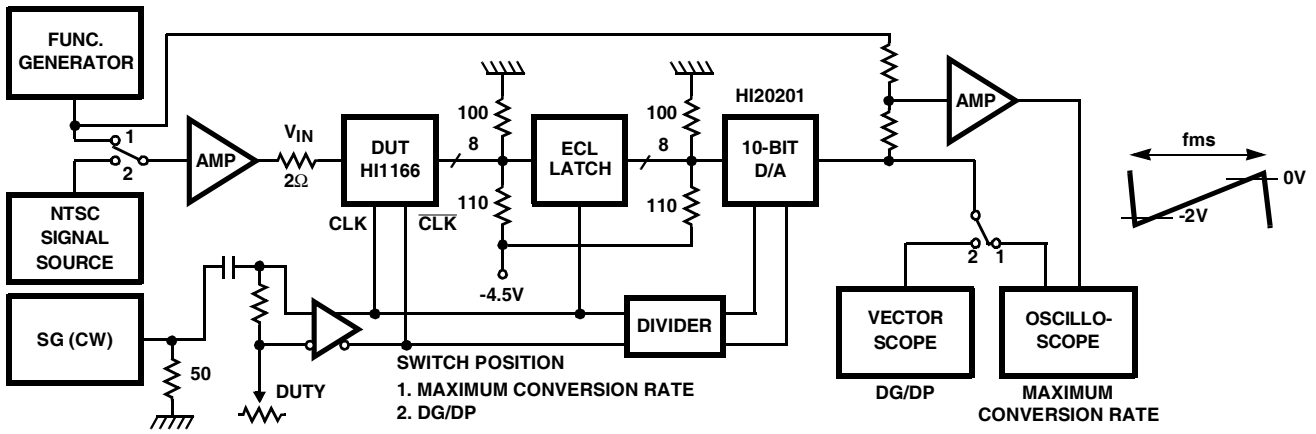

FIGURE 17. MAXIMUM CONVERSION RATE TEST CIRCUIT

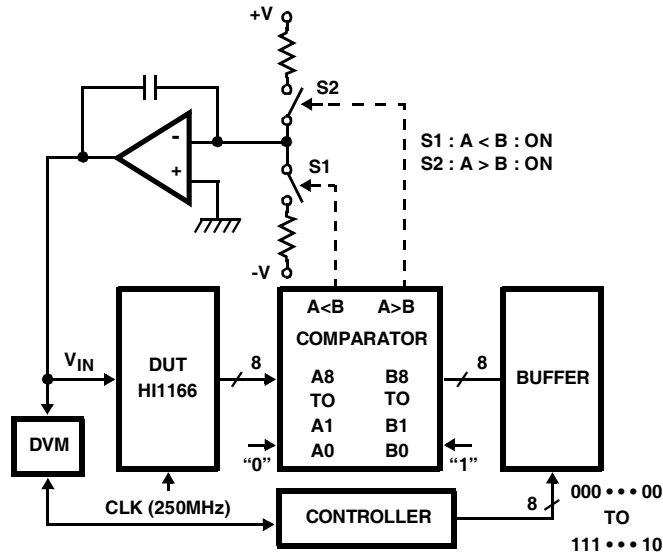

FIGURE 18. INTEGRAL AND DIFFERENTIAL LINEARITY ERROR TEST CIRCUIT

Test Circuits and Waveforms (Continued)

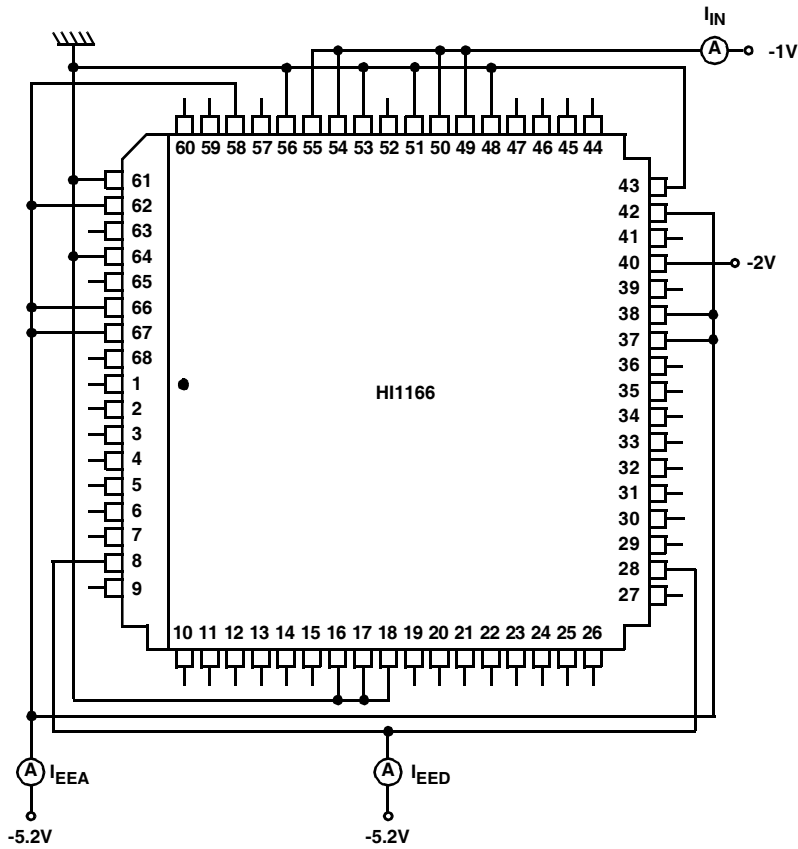

FIGURE 19. POWER SUPPLY AND ANALOG INPUT BIAS CURRENT TEST CIRCUIT

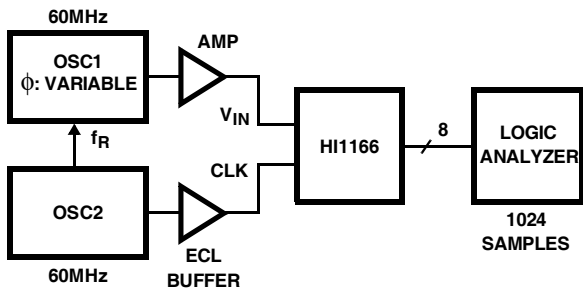
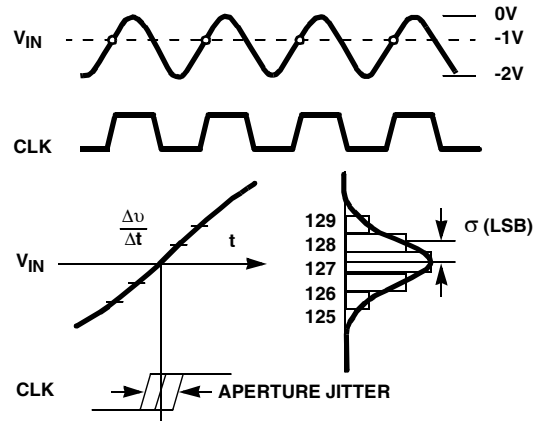

FIGURE 20A.



APERTURE JITTER IS DEFINED AS FOLLOWS:

$$t_{AJ} = \sigma / \frac{\Delta v}{\Delta t} = \sigma / \left(\frac{256}{2} \times 2\pi f \right)$$

Where σ (unit: LSB) is the deviation of the output codes when the input frequency is exactly the same as the clock and is sampled at the largest slew rate point.

FIGURE 20B. APERTURE JITTER TEST METHOD

FIGURE 20. SAMPLING DELAY AND APERTURE JITTER TEST CIRCUIT