

MAX POWER 30W BTL×4CH AUDIO POWER IC

The KIA8251AH is 4ch BTL audio power amplifier for consumer application.

It is designed low distortion ratio for 4ch BTL audio power amplifier, built-in stand-by function, muting function and junction temperature detection circuit.

Additionally, the AUX. amplifier is built-in, it can make the beep signal etc. output to 2 channels (OUT1 and 4).

It contains various kind of protectors for car audio.

FEATURES

- High Power
 - : $P_{OUT(MAX)}=30W(Typ.)$
($V_{CC}=13.7V$, $f=1kHz$, $R_L=4\Omega$)
 - : $P_{OUT(1)}=21W(Typ.)$
($V_{CC}=14.4V$, $f=1kHz$, $THD=10\%$, $R_L=4\Omega$)
 - : $P_{OUT(2)}=18W(Typ.)$
($V_{CC}=13.2V$, $f=1kHz$, $THD=10\%$, $R_L=4\Omega$)
- Low Distortion Ratio
 - : $THD=0.02\%(Typ.)$
($V_{CC}=13.2V$, $f=1kHz$, $P_{out}=3W$, $R_L=4\Omega$)
- Low Noise
 - : $V_{NO}=0.10mV_{rms}(Typ.)$
($V_{CC}=13.2V$, $R_g=0\Omega$, $G_v=34dB$, $BW=20\sim 20kHz$)
- Built-in stand-by switch function (Pin ②)
- Built-in muting function (Pin ①, ⑤)
- Built-in AUX. amplifier from single input to 2 channels output (Pin ⑩)
- Built-in junction temperature detection circuit (Pin ⑭)
 - : Pin ⑭ DC voltage rises at about $+10mV/^\circ C$ in proportion to junction temperature.
- Built-in various protection circuit.
 - : Thermal shut down, over voltage, out to GND, out to V_{CC} , out to out short.
- Operating supply voltage.
 - : $V_{CC(opr)}=9\sim 18V$.

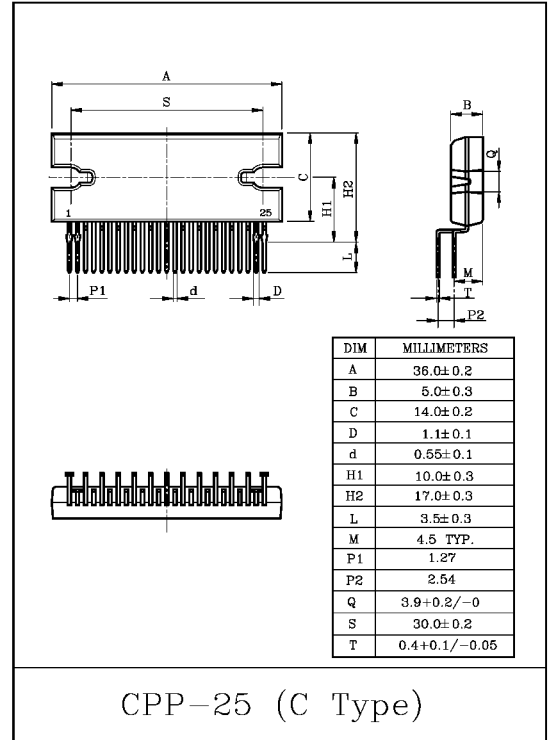

KIA8251AH

MAXIMUM RATINGS (Ta=25°C)

CHARACTERISTIC	SYMBOL	RATING	UNIT
Peak Supply Voltage (0.2sec)	V _{CC (surge)}	50	V
DC Supply Voltage	V _{CC (DC)}	25	V
Operating Supply Voltage	V _{CC (opr)}	18	V
Output Current (Peak)	I _{O (peak)}	9	A
Power Dissipation	P _{D (Note)}	83	W
Operating Temperature	T _{opr}	-40~85	°C
Storage Temperature	T _{stg}	-55~150	°C

Note) Package thermal resistance $\theta_{j-T}=1.5^{\circ}\text{C}/\text{W}$ (Typ.)
(Ta=25°C, with infinite heat sink)

ELECTRICAL CHARACTERISTICS

(Unless otherwise specified, V_{CC}=13.2V, R_L=4Ω, f=1kHz, Ta=25°C)

CHARACTERISTIC	SYMBOL	TEST CIRCUIT	TEST CONDITION	MIN.	TYP.	MAX.	UNIT
Quiescent Current	I _{CCQ}	-	V _{IN} =0	-	200	400	mA
Output Power	P _{OUT MAX}	-	V _{CC} =13.7V, MAX power	-	30	-	W
	P _{OUT(1)}	-	V _{CC} =14.4V, THD=10%	-	21	-	
	P _{OUT(2)}	-	THD=10%	16	18	-	
Total Harmonic Distortion Ratio	THD	-	P _{OUT} =3W	-	0.02	0.2	%
Voltage Gain	G _V	-	V _{OUT} =0.775V _{rms} (0dBm)	32	34	36	dB
Voltage Gain Ratio	ΔG _V	-	V _{OUT} =0.775V _{rms} (0dBm)	-1.0	0	1.0	
Output Noise Voltage	V _{NO (1)}	-	R _g =0Ω, DIN45405	-	0.12	-	mV _{rms}
	V _{NO (2)}	-	R _g =0Ω, BW=20Hz~20kHz	-	0.10	0.35	
Ripple Rejection Ratio	R.R.	-	f _{ripple} =100Hz, R _g =620Ω V _{rip} =0.775V _{rms} (0dBm)	40	55	-	dB
Cross Talk	C.T.	-	R _g =620Ω, V _{OUT} =0.775V _{rms} (0dBm)	-	75	-	
Output Offset Voltage	V _{OFFSET}	-	-	-300	0	300	mV
Input Resistance	R _{IN}	-	-	-	30	-	kΩ
Stand-By Current	I _{SB}	-	Stand-by condition	-	100	150	μA
Stand-By Control Voltage	V _{SB H}	-	Power : ON	3.0	-	V _{CC}	V
	V _{SB L}	-	Power : OFF	0	-	1.5	
Mute Control Voltage (Note)	V _{M H}	-	Mute : OFF	OPEN			
	V _{M L}	-	Mute : ON	0	-	1.5	
Mute Attenuation	ATT M	-	Mute : ON	-	70	-	dB

Note) Muting function must be controlled by open and low logic.
This means that the mute control terminal : pin⑤ must not be pulled up.

KIA8251AH

BLOCK DIAGRAM

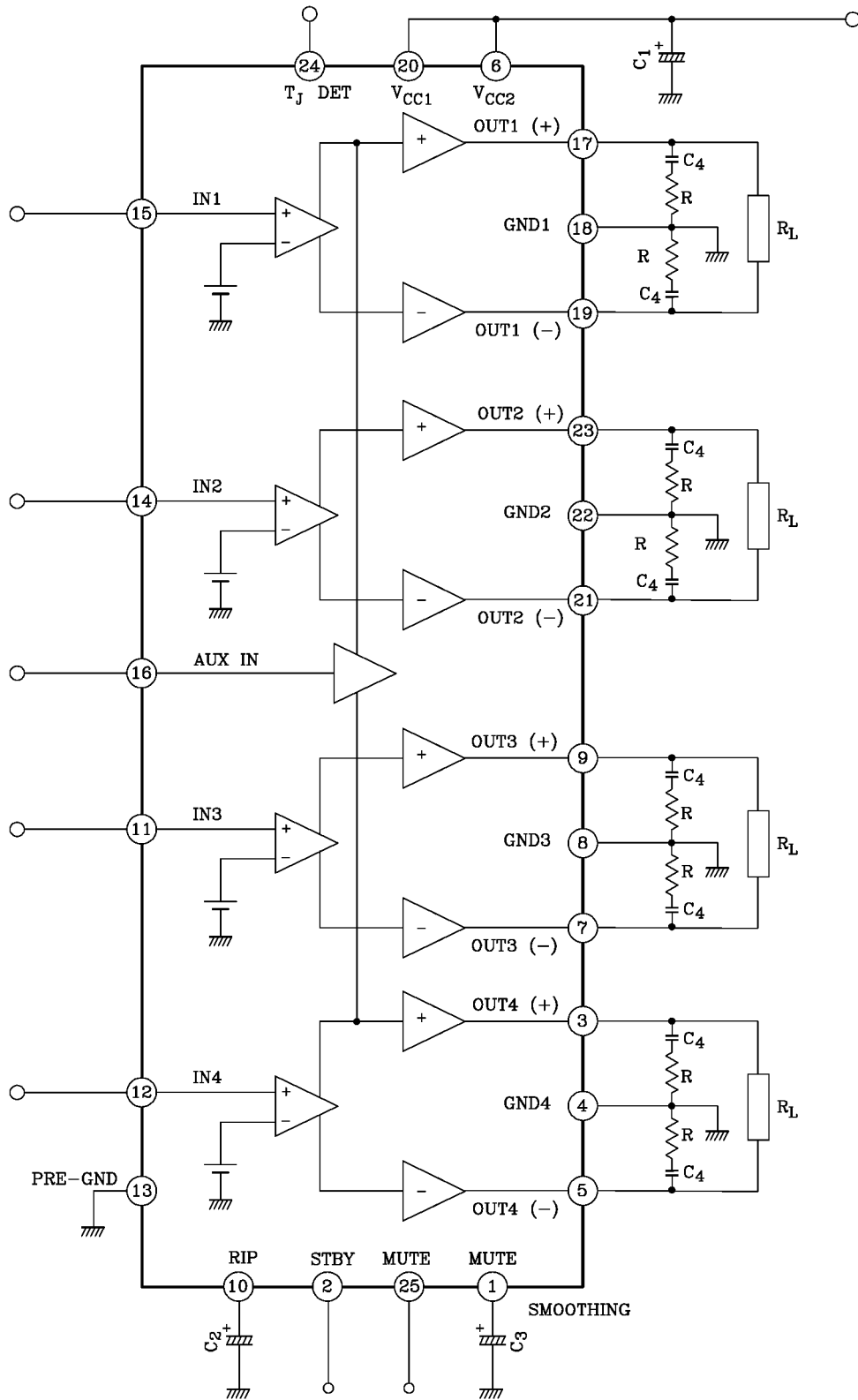

KIA8251AH

TEST CIRCUIT
($G_V=34\text{dB}$)

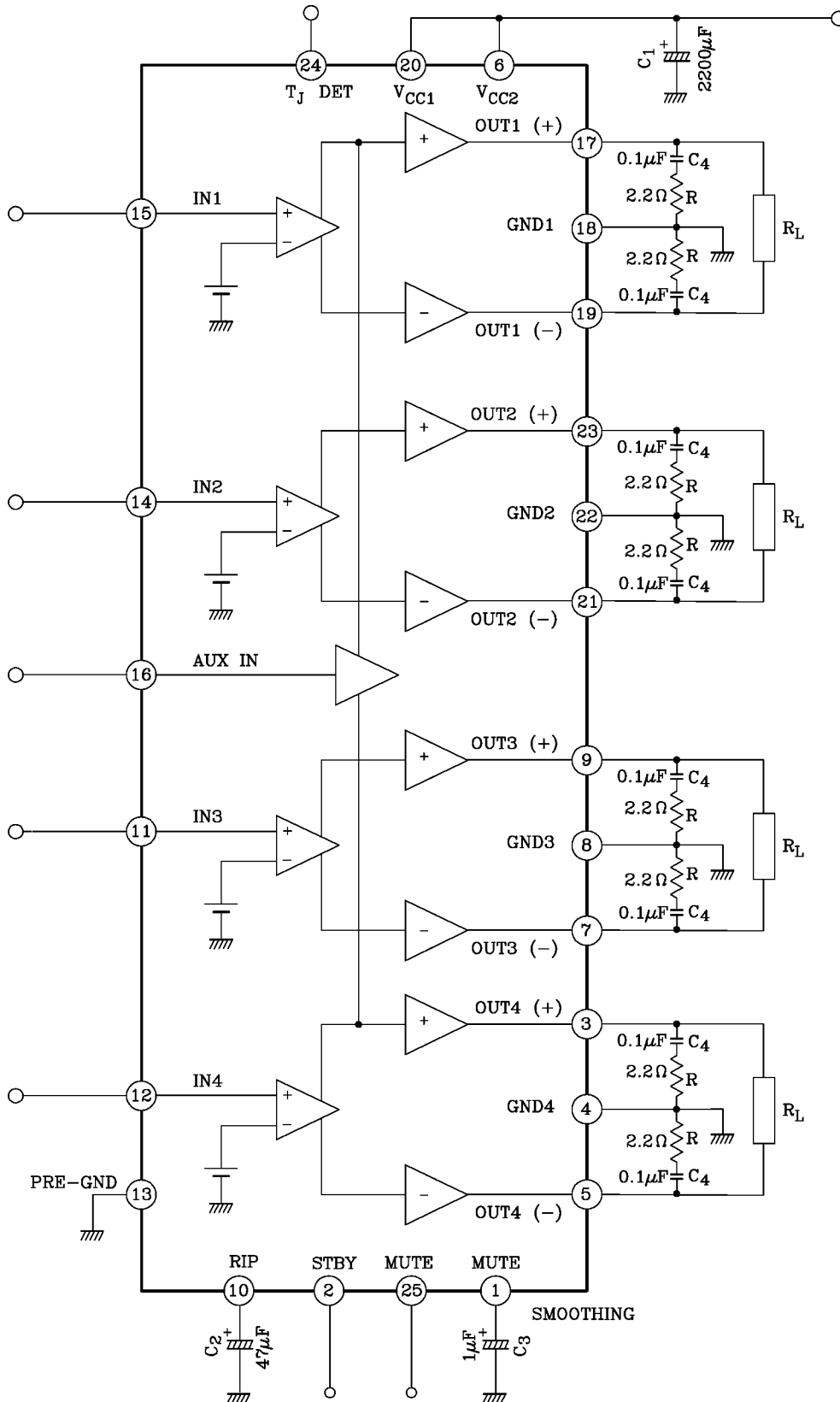

KIA8251AH

CAUTION AND APPLICATION METHOD

(Description is made only on the single channel.)

1. Voltage Gain Adjustment

This IC has no NF (negative feedback) terminals. Therefore, the voltage gain can't adjusted, but it makes the device a space and total costs saver.

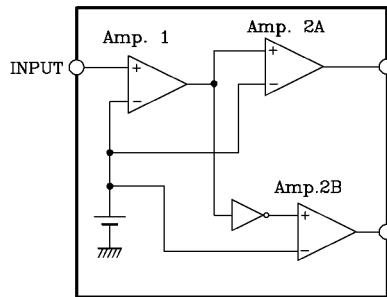

(Fig. 1) BLOCK DIAGRAM

The voltage gain of Amp. 1 : $G_{V1}=6\text{dB}$

The voltage gain of Amp. 2A, B : $G_{V2}=22\text{dB}$

The voltage gain of BTL Connection : $G_{V(\text{BTL})}=6\text{dB}$

Therefore, the total voltage gain is decided by expression below.

$$G_V = G_{V1} + G_{V2} + G_{V(\text{BTL})} = 6 + 22 + 6 = 34\text{dB}$$

2. Stand-by SW function

By means of controlling pin ② (Stand-by terminal) to High and Low, the power supply can be set to ON and OFF. The threshold voltage of pin ② is set at about 3V (Typ.), and the power supply current is about $100\mu\text{A}$ (Typ.) at the stand-by state.

Control Voltage of pin ② : $V_{(\text{SB})}$

Stand-By	Power	$V_{(\text{SB})}$ (V)
ON	OFF	0 ~ 2
OFF	ON	3 ~ V_{CC}

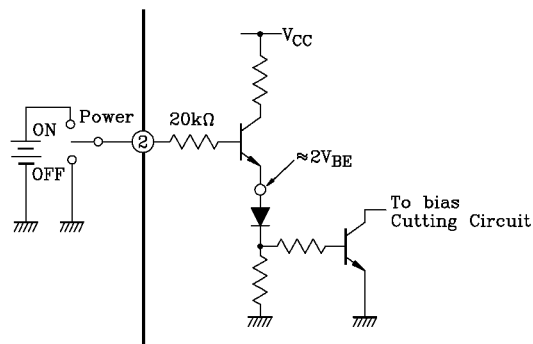

(Fig.2) With pin ② set to High, Power is turned ON.

~ Adjustage of Stand-By SW ~

- ① Since V_{CC} can directly be controlled to ON or OFF by the microcomputer, the switching relay can be omitted.
- ② Since the control current is microscopic, the switching relay of small current capacity is satisfactory for switching.

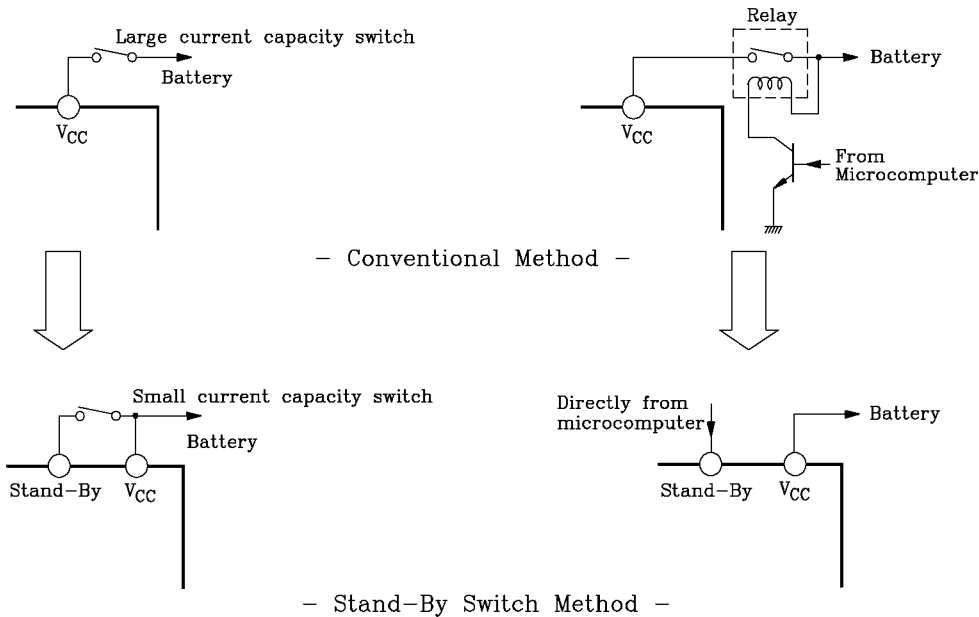

3. Preventive Measure Against Oscillation

For preventing the oscillation, it is advisable to use C₄, the condenser of polyester film having small characteristic fluctuation of the temperature and the frequency.

The resistance R to be series applied to C₄ is effective for phase correction of high frequency, and improves the oscillation allowance.

- ① Capacity value and the kind of condenser
- ② Layout of printed board

4. Junction Temperature Detecting pin ⑭

Using temperature characteristic of a band gap circuit and in proportion to junction temperature, pin ⑭ DC voltage : V₂ rises at about +10mV/°C temperature characteristic. So, the relation between V₂ at T_j=25°C and V_{2X} at T_j=X°C is decided by the following expression :

$$T(X^\circ\text{C}) = \frac{V_{2X} - V_2(25^\circ\text{C})}{10\text{mV}/^\circ\text{C}} + 25(^\circ\text{C})$$

In deciding a heat sink size, a junction temperature can be easily made clear by measuring voltage at this pin while a backside temperature of IC was so far measured using a thermocouple type thermometer.

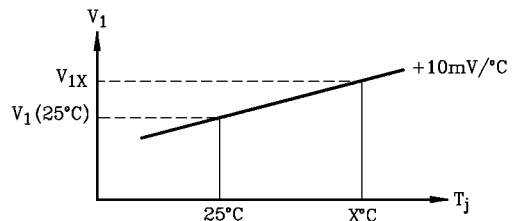

(Fig. 3)

KIA8251AH

5. Muting function : pin ①, pin ⑫

By means of controlling pin ⑫ (Mute control terminal) less than about 1.5V, it can make the IC muting condition as below. However, Pin ⑫ must not be connected to a certain voltage, for example, V_{CC} , V_{DD} , V_{ref} ... etc. In other words, Pin ⑫ is inhibited to be pulled up, for instance fig.5 application.

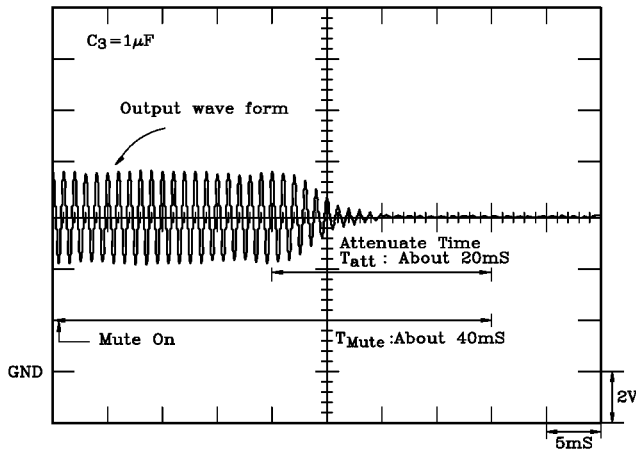

(Fig. 4) Output wave form at Muting Condition

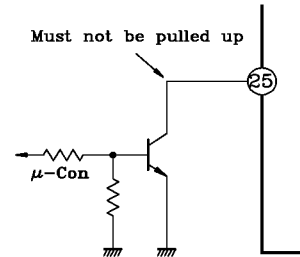

(Fig. 5) Mute control

The attenuation by the muting function is 70dB (Typ.). This muting is very smooth attenuating by the time constant of pin ① : smoothing.

Therefore, this function is suitable to the audio muting. The time for attenuation : T_{att} is adjustable by changing the capacitance of C_3 . But the T_{att} may influence the popping noise level.

So, please decide the time of T_{att} by testing on the units.

6. AUX. amplifier : pin ⑮

The pin ⑮ is for input terminal of AUX. amplifier.

The total gain is 0dB by using of AUX. amplifier.

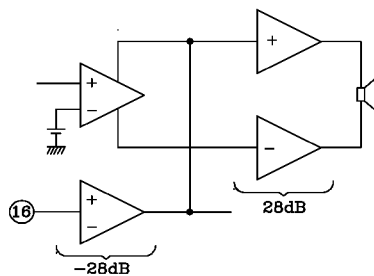

(Fig. 6) AUX. Amplifier

Therefore, the μ -Con can directly drive the AUX. amplifier.

KIA8251AH

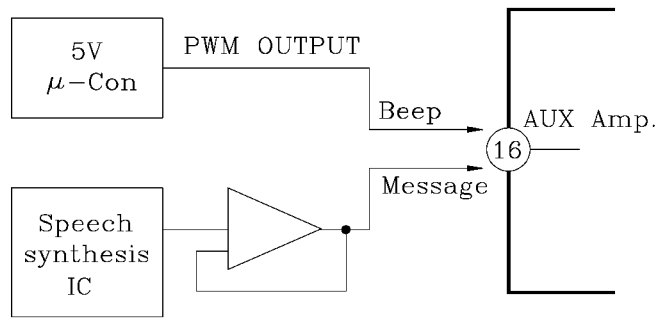

(Fig.7) The application of AUX. AMPLIFIER

The amplified signal from pin ⑯ is out to the OUT1 and 4.

7. Cross talk

The cross talk characteristics of the IC is not good between OUT1 and 2, OUT3 and 4. So we recommend to use by below method.

OUT 1, 2	L-ch (or R-ch)
OUT 3, 4	R-ch (or L-ch)

And, please refer to below table in case of applying the AUX. IN because it is out to OUT1 and 4.

ex)

OUT 1	Front	L-ch (or R-ch)	AUX. OUT
OUT 2	Rear		-
OUT 3	Rear	R-ch (or L-ch)	-
OUT 4	Front		AUX. OUT

KIA8251AH

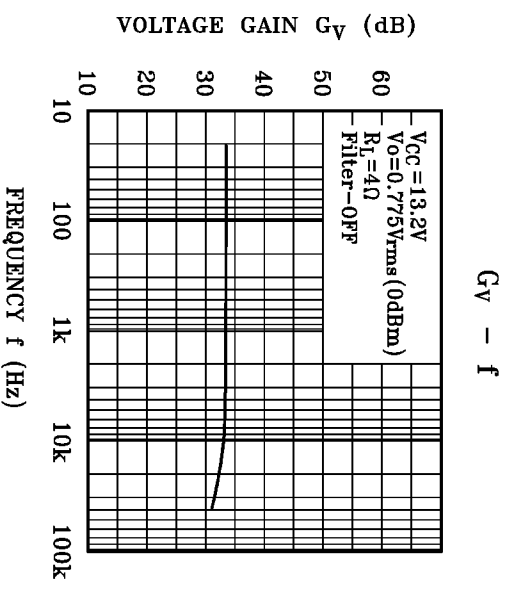
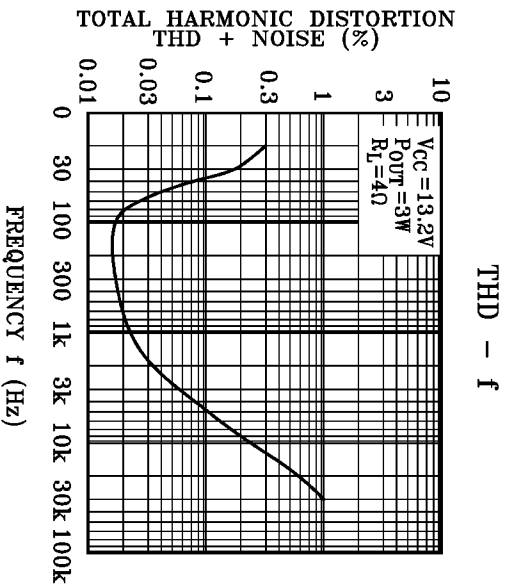
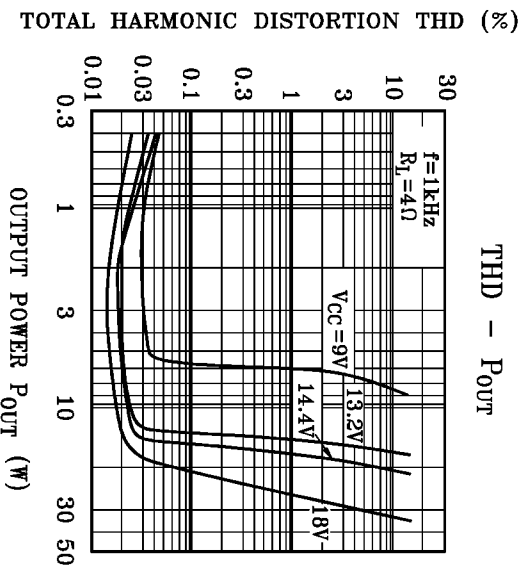
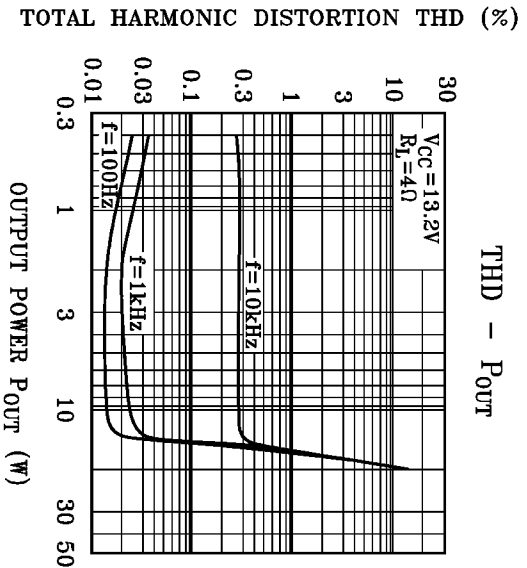
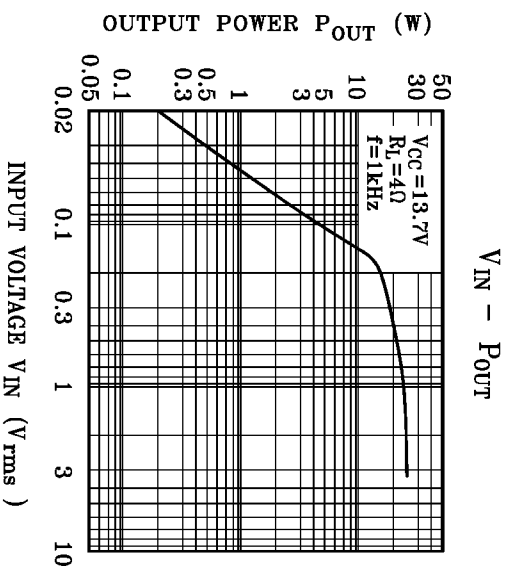
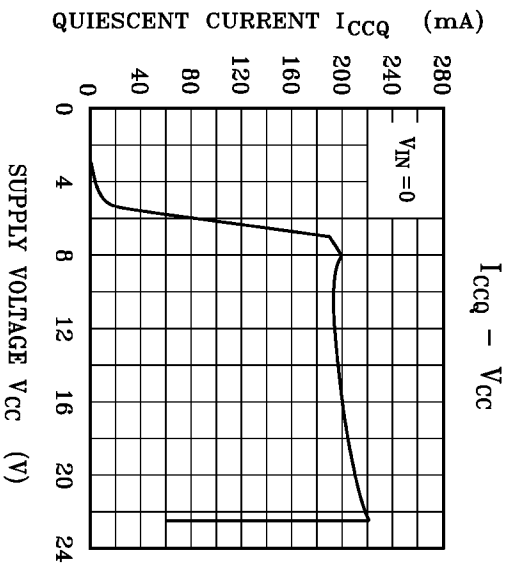

KIA8251AH

C.T - f(Out-1)

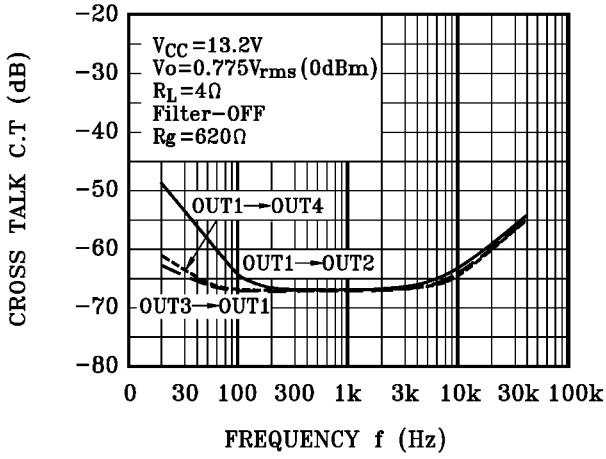

C.T - f(OUT-2)

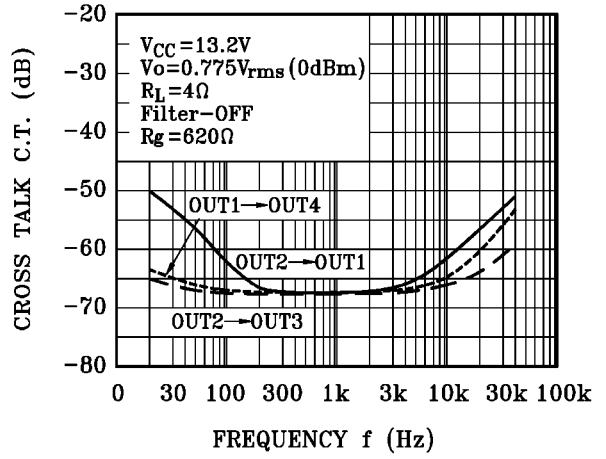

C.T - f(Out-3)

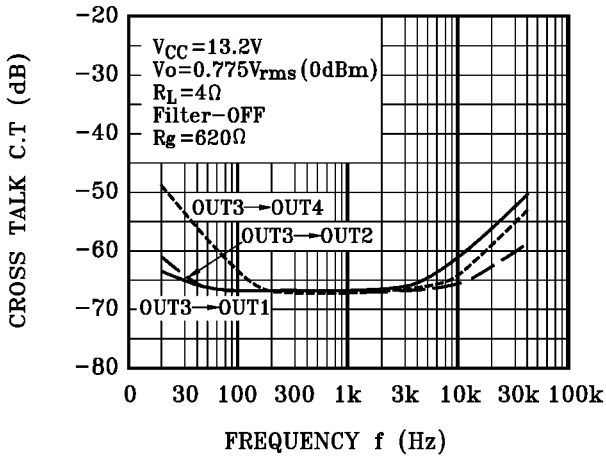

C.T - f(OUT-4)

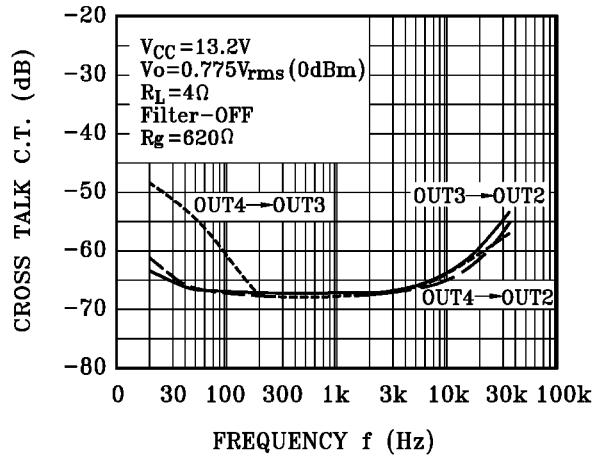

RR - f

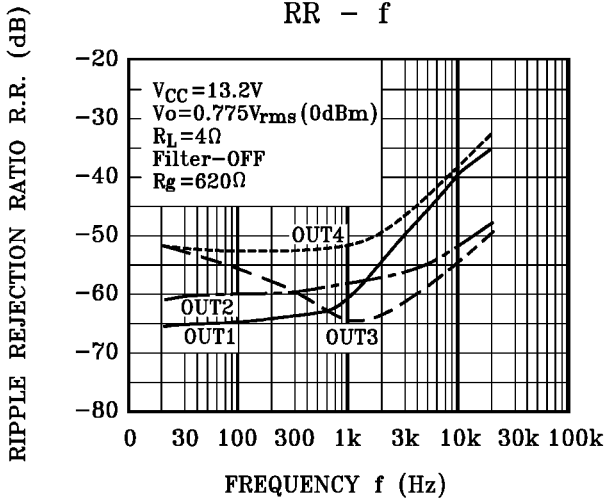

$V_{NO} - R_g$

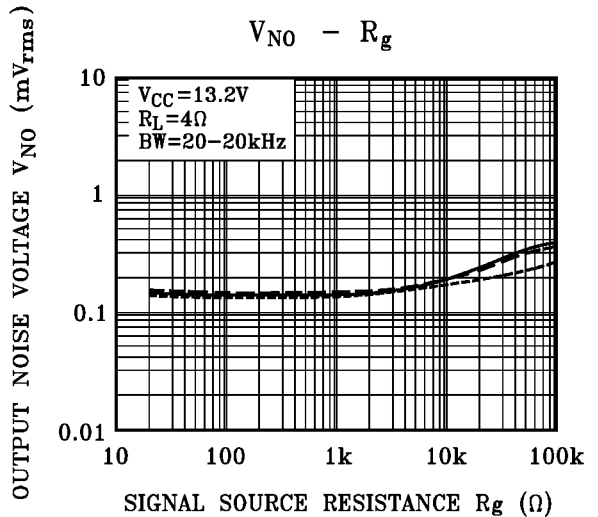

KIA8251AH

$V_{NO} - R_g$

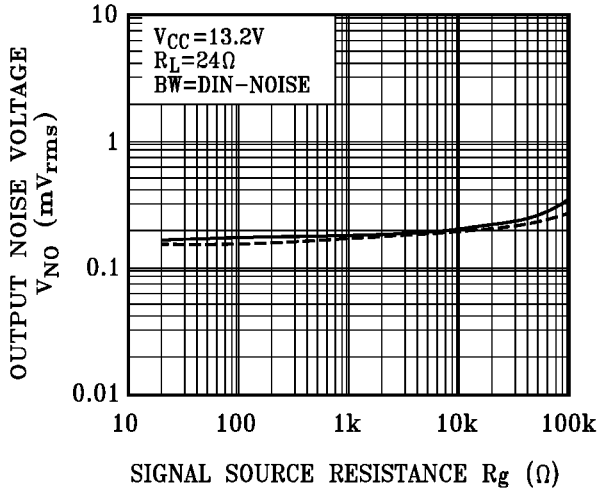

$P_D - R_{OUT}$

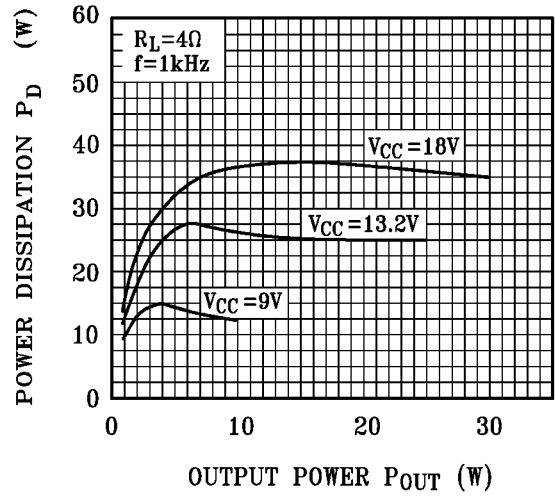

$P_D - T_a$

