

### THREE AUDIO POWER AMPLIFIER

The KIA8256H is 3 channel audio power amplifier for consumer applications.

This IC provides an output power of 6 watts per channel (at  $V_{CC}=20V$ ,  $f=1kHz$ ,  $THD=0\%$ ,  $R_L=8\Omega$ )

It is suitable for power amplifier of TV and home stereo.

#### FEATURES :

- Built-in 3ch Amplifier.
- High Output Power :  $P_{OUT}=6W$ (Typ.)  
( $V_{CC}=20V$ ,  $f=1kHz$ ,  $THD=10\%$ ,  $R_L=8\Omega$ )
- Built in audio muting circuit.
- NF terminal capacitor less  
: Fixed gain( $G_v=34dB$ ), needless external capacitor.
- Protectors  
Thermal shut down protection circuit  
Over voltage protection circuit.
- Low Popping Noise.
- Hi THD Ratio.
- Hi Input Dynamic Range.
- Available for using same PCB layout with 2 channel IC : KIA8246H.
- Operating Supply Voltage Range :  $V_{CC(opr)}=10\sim 30V$ .( $T_a=25^\circ C$ )

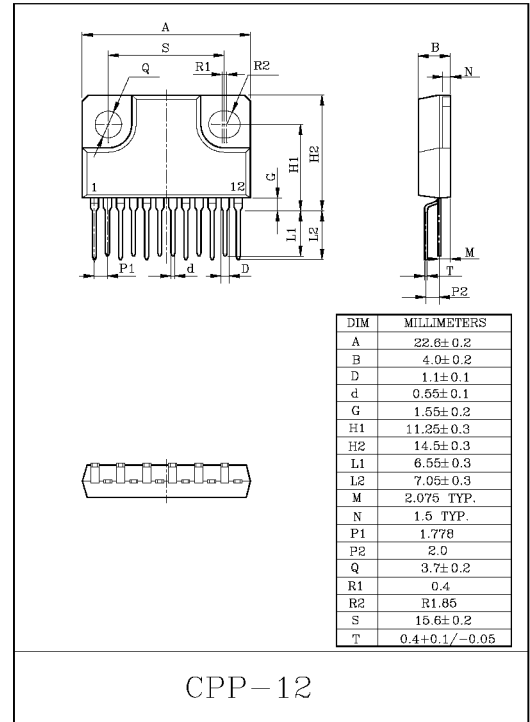

#### MAXIMUM RATINGS ( $T_a=25^\circ C$ )

CHARACTERISTIC	SYMBOL	RATING	UNIT
Supply Voltage	$V_{CC}$	30	V
Output Current (Peak/ch)	$I_o$ (Peak)	2.0	A
Power Dissipation	$P_D$ (Note)	25	W
Operating Temperature	$T_{opr}$	-20~75	$^\circ C$
Storage Temperature	$T_{stg}$	-55~150	$^\circ C$

(Note) Derated above  $T_a=25^\circ C$  in the proportion of 200mW/ $^\circ C$  for KIA8256H.

# KIA8256H

## ELECTRICAL CHARACTERISTICS

(Unless otherwise specified,  $V_{CC}=20V$ ,  $R_g=620\Omega$ ,  $R_L=8\Omega$ ,  $f=1kHz$ ,  $T_a=25^\circ C$ )

CHARACTERISTIC	SYMBOL	TEST CIRCUIT	TEST CONDITION	MIN.	TYP.	MAX.	UNIT
Quiescent Current	$I_{CCQ}$	-	$V_{IN}=0$	65	100	180	mA
Output Power	$P_{OUT(1)}$	-	THD=10%	5	6	-	W
	$P_{OUT(2)}$	-	THD=1%	-	4.5	-	
Total Harmonic Distortion	THD(1)	-	$P_{OUT}=2W$	-	0.04	0.2	%
	THD(2)	-	$P_{OUT}=2W$ , $f=10kHz$	-	0.1	0.6	
Voltage Gain	$G_V$	-	$V_{OUT}=0.775V_{rms}$	32.5	34	35.5	dB
Input Resistance	$R_{IN}$	-	-	-	34	-	$k\Omega$
Ripple Rejection Ratio	R.R	-	$f=100Hz$ , $V_{ripple}=0.775V_{rms}$	-40	-47	-	dB
Output Noise Voltage	$V_{NO}$	-	$R_g=10k\Omega$ , $BW=20Hz \sim 20kHz$	-	0.14	0.3	$mV_{rms}$
Cross Talk	C.T.	-	$V_{OUT}=0.775V_{rms}$	-	-60	-	dB
Mute Control Voltage	$V_{th(ON)}$	-	MUTE ON	3.1	-	$V_{CC}$	V
	$V_{th(OFF)}$	-	MUTE OFF	0	-	2.5	
Mute attenuation Level	ATT	-	$V_{out}=0.775V_{rms} \rightarrow$ MUTE	-52	-60	-	dB

## BLOCK DIAGRAM

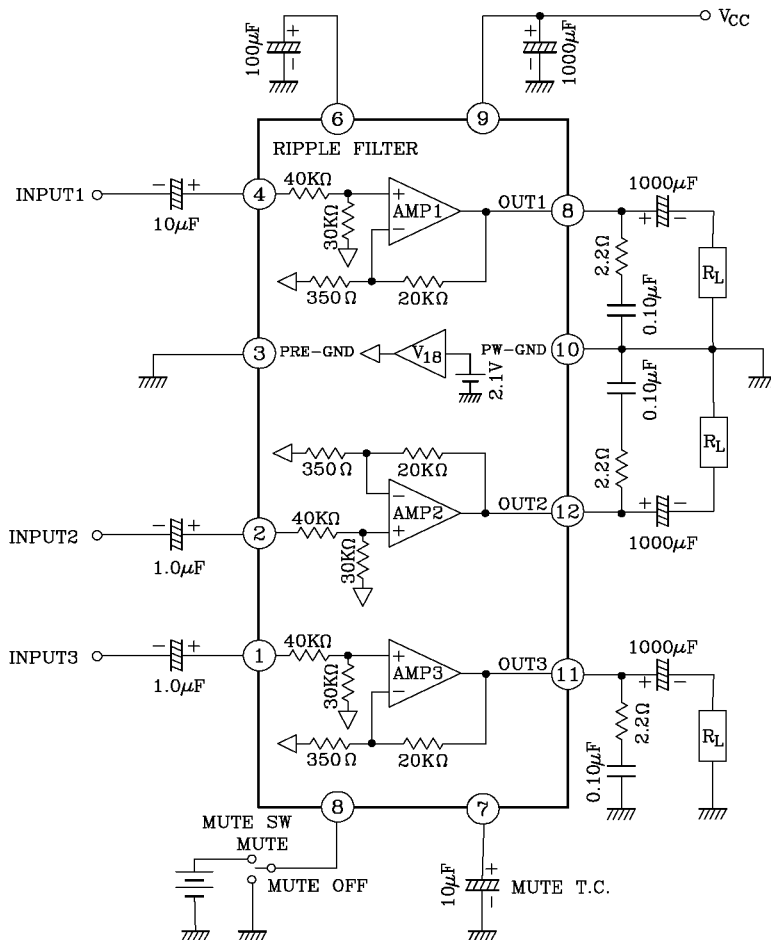

# KIA8256H

## EXPLANATION OF TERMINALS

TERMINAL No.	SYMBOL	FUNCTION	EQUIVALENT CIRCUIT
1	IN3	INPUT	
2	IN2		
4	IN1		
3	PRE-GND	GND terminal	
5	MUTE.S.W	MUTE control terminal	
7	MUTE.T.C		
6	RF	Ripple filter	
8	OUT1	Output	
11	OUT3		
12	OUT2		
9	VCC	Supply voltage terminal	-
10	PW-GND	GND terminal	-

# KIA8256H

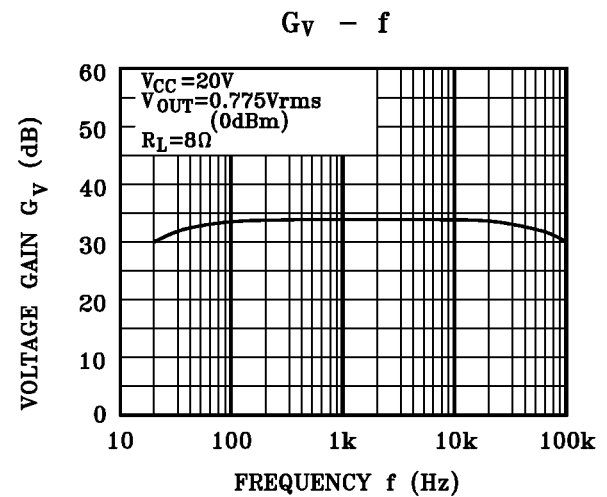
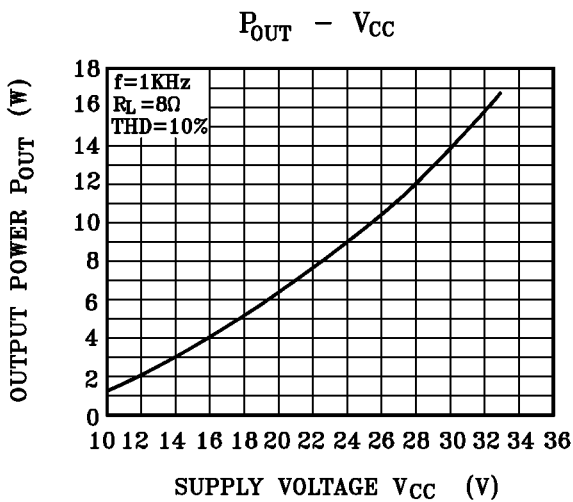
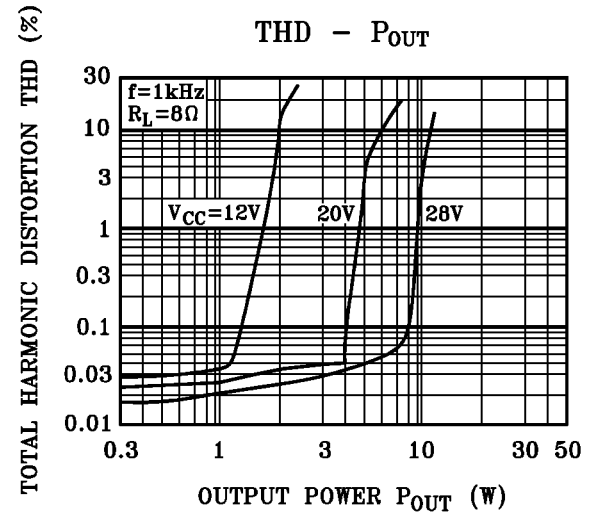
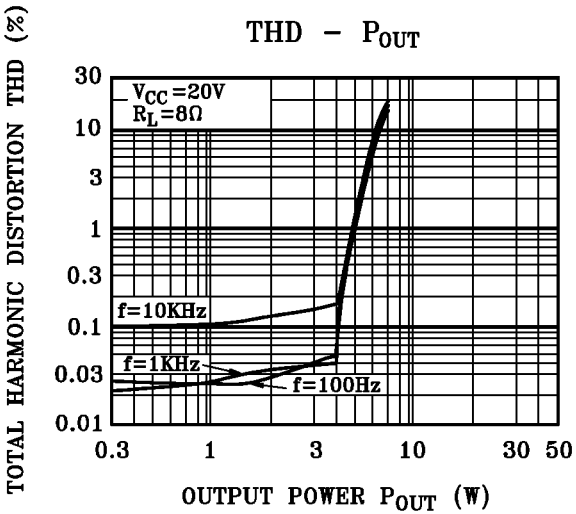
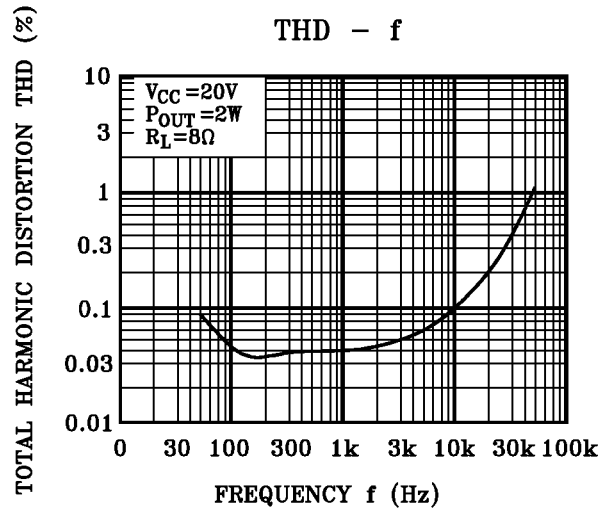
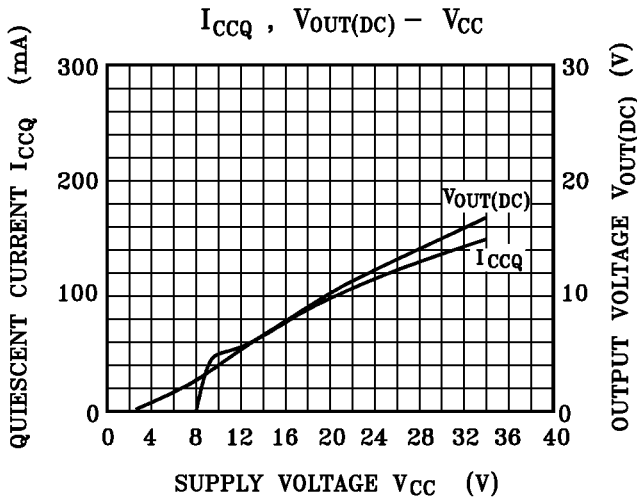

# KIA8256H

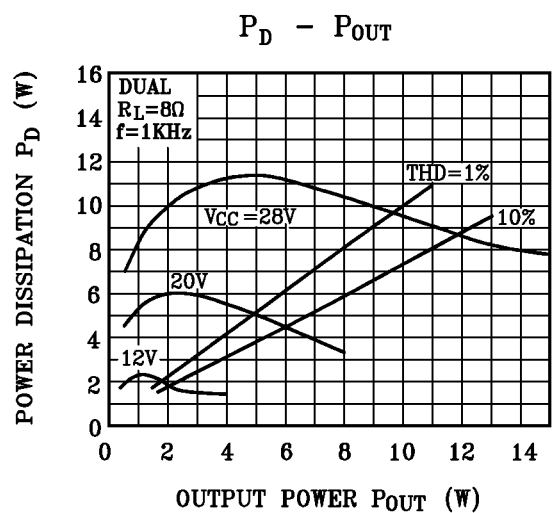
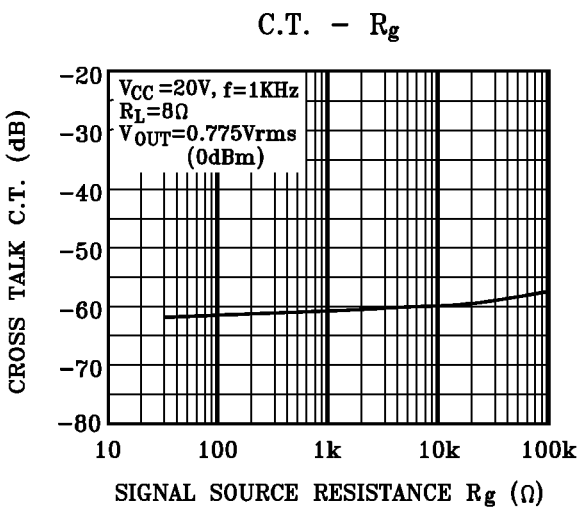
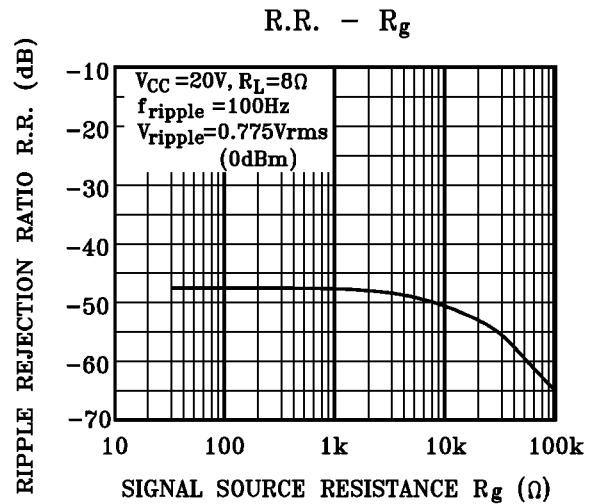
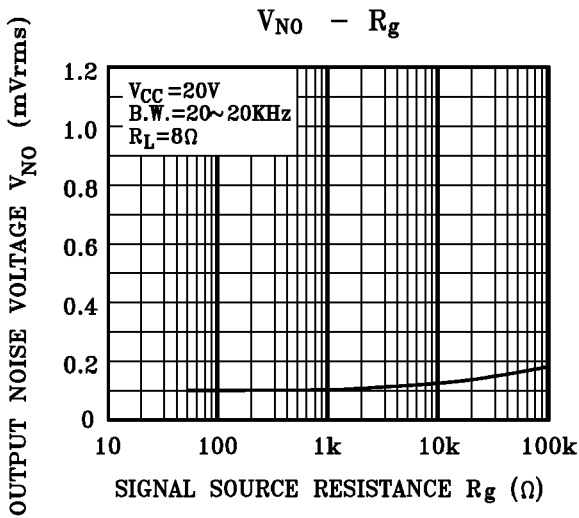
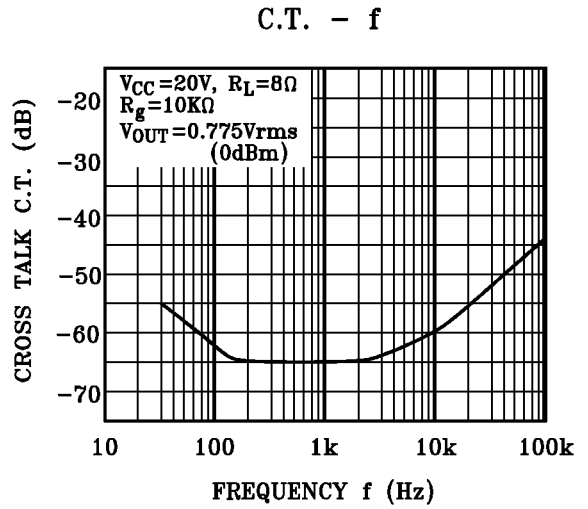
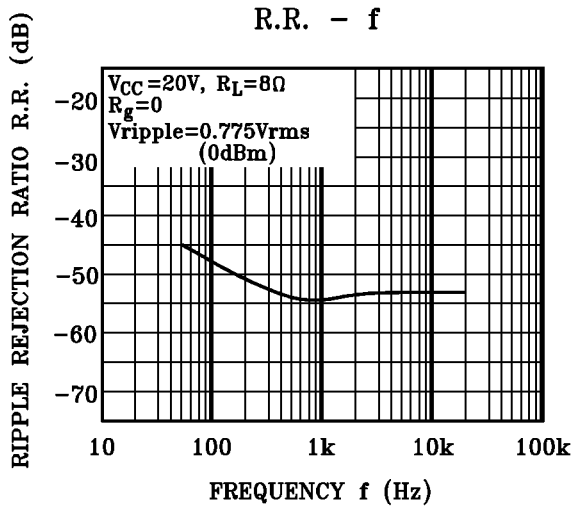

# KIA8256H

$P_D - P_{OUT}$

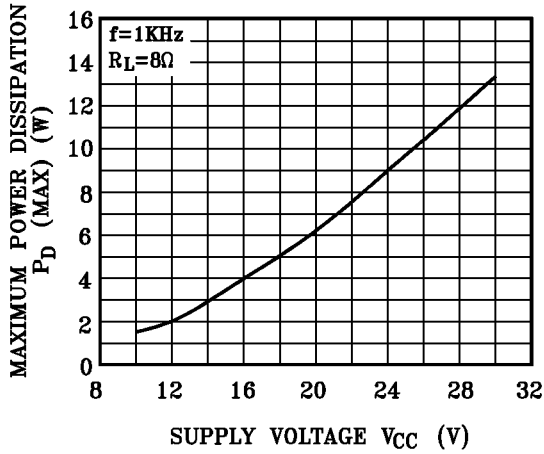

$I_{CCQ} - T_a$

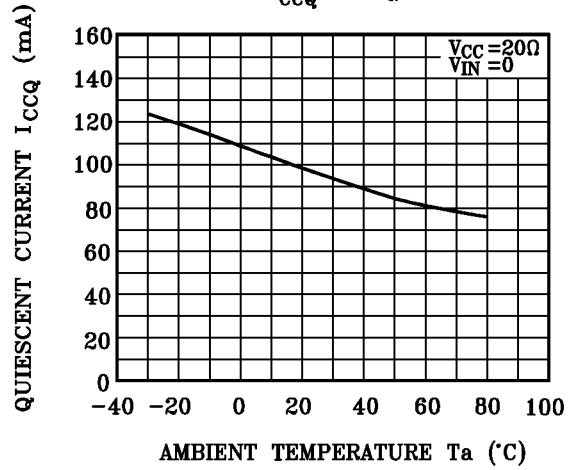

$V_{NO} - T_a$

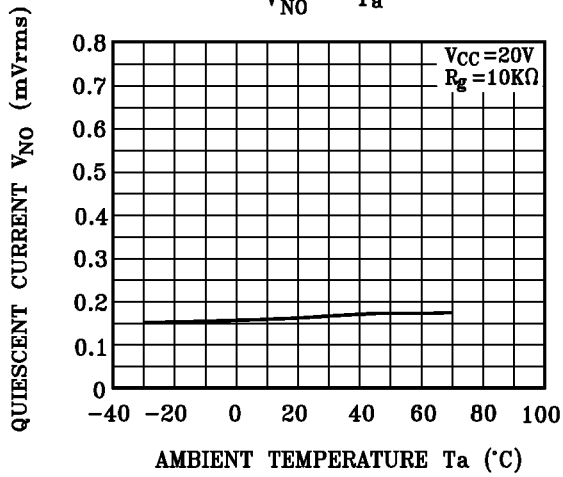

THD -  $T_a$

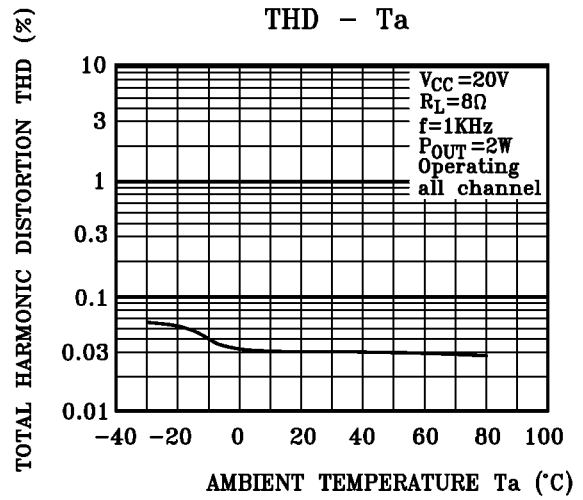

$P_D \text{ MAX} - T_a$

