

**LA4906**

## 17-W, 2-Channel BTL AF High-Efficiency Power Amplifier for Car Audio Systems

### Preliminary

### Overview

The LA4906 is a BTL two-channel power amplifier for use in car audio systems. It uses a signal-following switching technique in the power supply for the amplifier output stage and a newly-developed nonlinear amplifier that features nonlinear characteristics in the signal system. These features hold increases in the number of external components to a minimum, and reduce power dissipation (and thus heat generation) in the practical operating region to about 1/2 that of earlier class B amplifier ICs. This can contribute significantly to miniaturization and weight reduction in the heat sink and to reduction of the heat generated within the end product case.

### Features

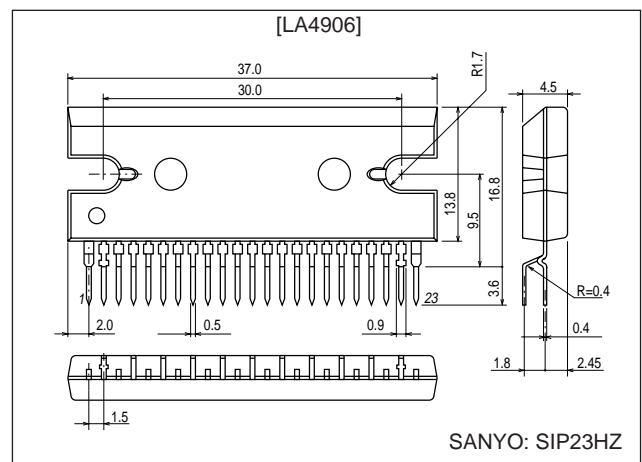
- Power dissipation reduced by 50% (for music at average power levels, as compared to earlier Sanyo products)
- The number of required signal-following switching circuits has been reduced to just one circuit for two channels, reducing the number of external components.
- The output is a pure analog signal; no switching noise whatsoever appears on the output lines.

- Uses a single-voltage power supply from 8 to 18 V.
- Provides a full range of built-in protection circuits, including shorting of output pin to  $V_{CC}$ , shorting of output pin to ground, overvoltage, and thermal shutdown protection.
- Built-in standby switch
- Clipping detection function

### Package Dimensions

unit: mm

#### 3160-SIP23HZ



### Specifications

#### Maximum Ratings at $T_a = 25^\circ\text{C}$

Parameter	Symbol	Conditions	Ratings	Unit
Maximum supply voltage	$V_{CC\ max1}$	With no signal, $t = 1$ minute	18	V
	$V_{CC\ max2}$		16	V
Maximum output current	$I_O\ Peak$	Per channel	4.5	A
Allowable power dissipation	$P_d\ max$	With an arbitrarily large heat sink	37.5	W
Operating temperature	$T_{opr}$		-35 to +85	$^\circ\text{C}$
Storage temperature	$T_{stg}$		-40 to +150	$^\circ\text{C}$

Notes: 1. Set  $V_{CC}$  and  $R_L$  to be in the range where  $P_d\ max$  does not exceed 37.5 W.  
2. The overvoltage protection circuit operates at  $V_{CC} = 26$  V or higher.

■ Any and all SANYO products described or contained herein do not have specifications that can handle applications that require extremely high levels of reliability, such as life-support systems, aircraft's control systems, or other applications whose failure can be reasonably expected to result in serious physical and/or material damage. Consult with your SANYO representative nearest you before using any SANYO products described or contained herein in such applications.

■ SANYO assumes no responsibility for equipment failures that result from using products at values that exceed, even momentarily, rated values (such as maximum ratings, operating condition ranges, or other parameters) listed in products specifications of any and all SANYO products described or contained herein.

**SANYO Electric Co.,Ltd. Semiconductor Company**

TOKYO OFFICE Tokyo Bldg., 1-10, 1 Chome, Ueno, Taito-ku, TOKYO, 110-8534 JAPAN

## LA4906

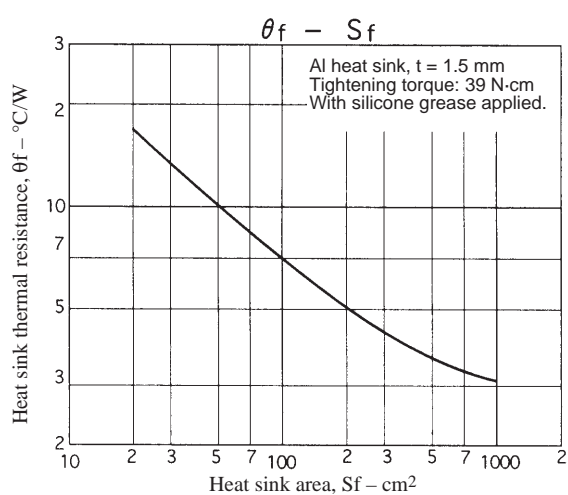
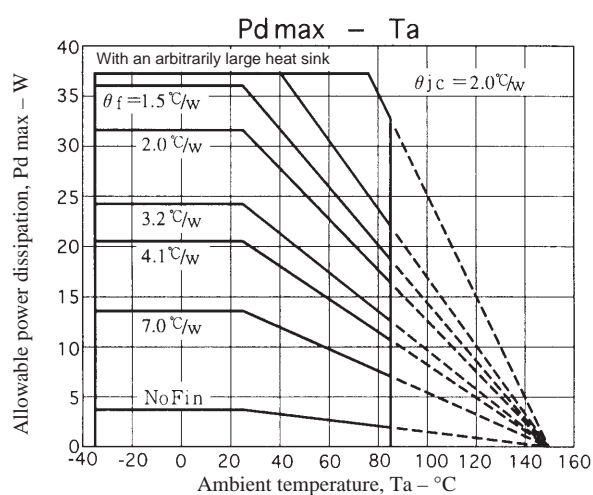
### Operating Conditions at $T_a = 25^\circ\text{C}$

Parameter	Symbol	Conditions	Ratings	Unit
Recommended supply voltage	$V_{CC}$		13.2	V
Allowable operating voltage range	$V_{CC\text{ op}}$		8 to 16	V
Recommended load resistance	$R_L$		4	$\Omega$
Recommended load resistance range	$R_{L\text{ op}}$		2 to 4	$\Omega$

Note: Set  $V_{CC}$  and  $R_L$  to be in the range where  $P_d\text{ max}$  does not exceed 37.5 W.

### Operating Characteristics at $T_a = 25^\circ\text{C}$ , $V_{CC} = 13.2\text{ V}$ , $R_L = 4\ \Omega$ , $f = 1\text{ kHz}$ , $R_G = 600\ \Omega$ , in the recommended circuit

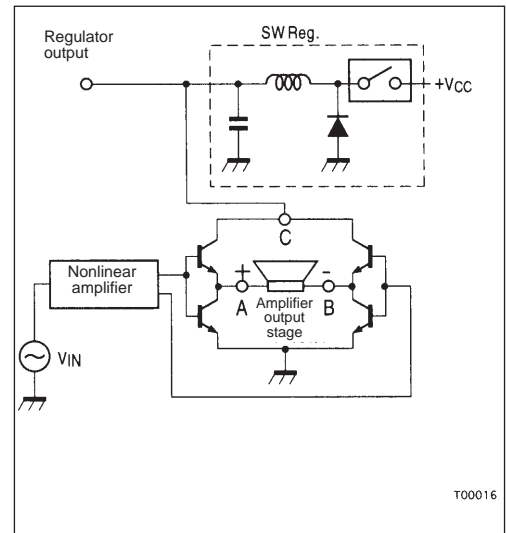
Parameter	Symbol	Conditions	Ratings			Unit
			min	typ	max	
Quiescent current drain	$I_{CCO}$	$R_L = \infty, V_{IN} = 0$	80	110	150	mA
Standby current	$I_{st}$			0	10	$\mu\text{A}$
Voltage gain	VG	$V_O = 0\text{ dBm}$	28	30	32	dB
Total harmonic distortion	THD	$P_O = 1\text{ W}, \text{LPF} = 30\text{ kHz}$		0.07	0.2	%
Output power	$P_{O1}$	THD = 10 %, $R_L = 4\ \Omega$	14	17		W
		THD = 10 %, $R_L = 2\ \Omega$		25		W
Output noise voltage	$V_{NO}$	$R_g = 0, \text{BPF} = 20\text{ Hz to } 20\text{ kHz}$		0.10	0.3	mVrms
Ripple rejection ratio	SVRR	$R_g = 0, V_{CCR} = 0\text{ dBm}, \text{BPF} = 20\text{ Hz to } 20\text{ kHz}$	60	75		dB
Channel separation	CH sep	$R_g = 10\text{ k}\Omega, V_O = 0\text{ dBm}, \text{BPF} = 20\text{ Hz to } 20\text{ kHz}$	45	60		dB
Input resistance	$R_i$		21	30	39	$\text{k}\Omega$
Output offset voltage	$V_N\text{ offset}$	$R_g = 0$	-200		+200	mV
Standby on voltage	$V_{STH}$	AMP = on, applied through a $10\text{ k}\Omega$ resistor	3		$V_{CC}$	V
Clipping detect off current	$I_{DOFF}$	THD = 1 %		1	10	$\mu\text{A}$
Clipping detect on current	$I_{DON}$	THD = 10 %	100	150	200	$\mu\text{A}$



**Technologies for Increased Efficiency Used in the LA4906**

• Signal-following switching technique

The LA4906 uses a switching regulator for the power supply for the amplifier output stage. The LA4906 significantly reduces power dissipation by having the switching regulator output voltage follow the signal. Also, the LA4906 restricts the number of switching regulators required to just one circuit even though it implements a BTL 2-channel amplifier by using the switching regulator in combination with the nonlinear amplifier described below. (See Figure 1.)

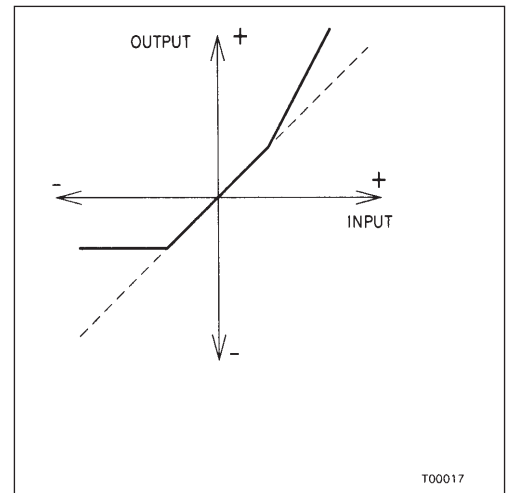


**Figure 1 Overview Block Diagram**

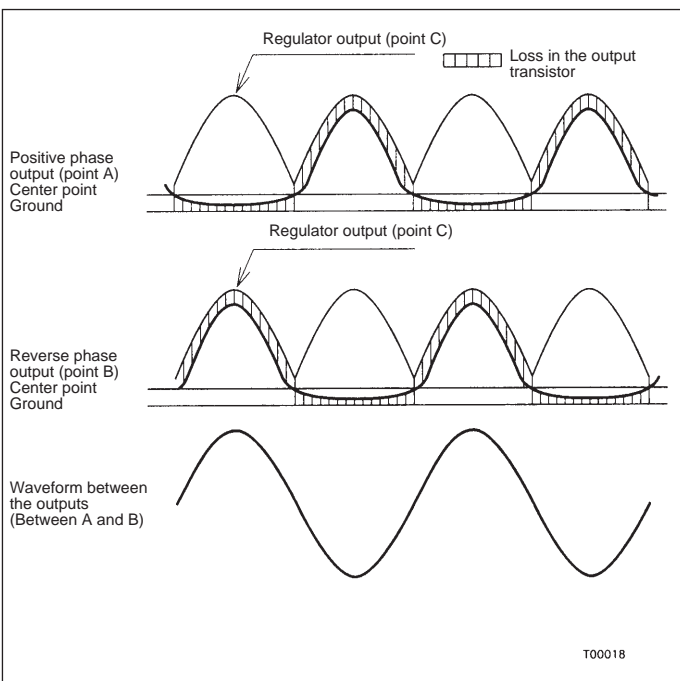
• Nonlinear amplifier

The LA4906 adopts a nonlinear amplifier, which has the nonlinear characteristics shown in Figure 2, in the signal system. The LA4906 dispenses with the lower side switching regulator by using a low 2 V as the midpoint voltage instead of the 1/2 VCC used in normal amplifiers.

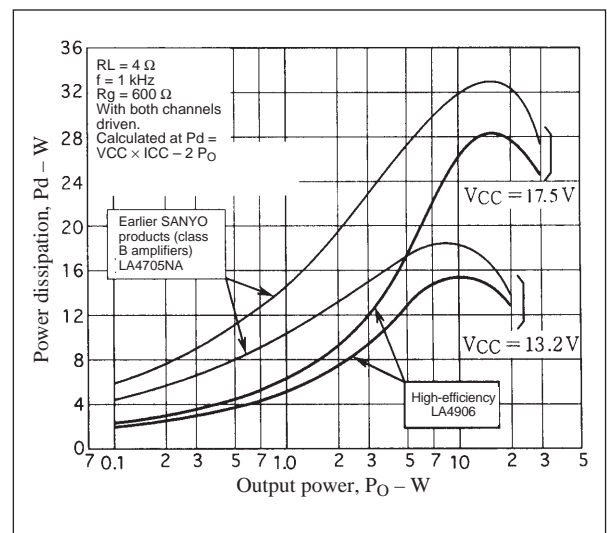
This nonlinear amplifier is basically formed from a differential amplifier that has a symmetrical negative feedback circuit. Although the BTL output stage positive and reverse phase output waveforms have a half-wave waveform that, when referenced to ground, is expanded and compressed as shown in Figure 3, the combined output waveform at the load terminals is identical to that of earlier products.



**Figure 2 Nonlinear Amplifier Input/Output Characteristics**

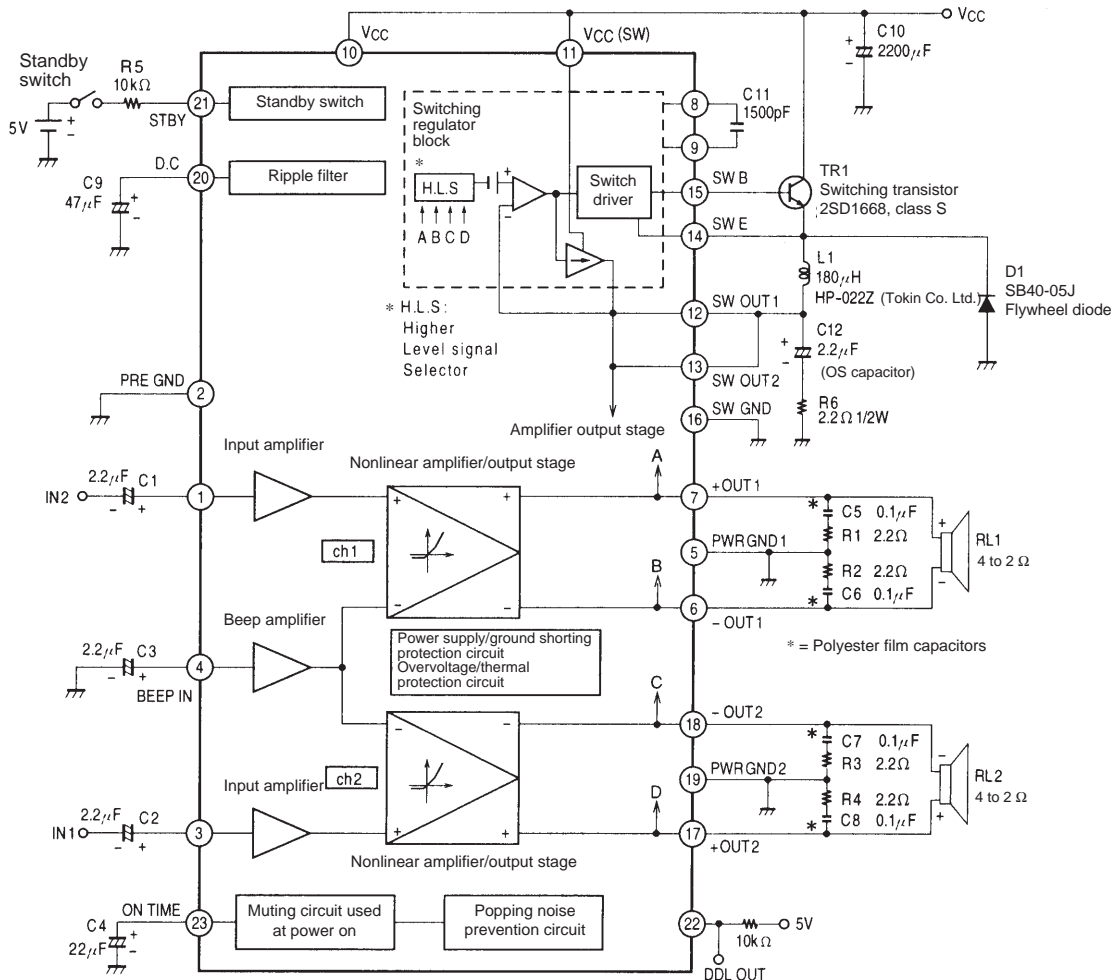


**Figure 3 Output Waveforms**



**Figure 4 Power Dissipation Comparison with Earlier Sanyo Products**

Equivalent Circuit Block Diagram



T000069

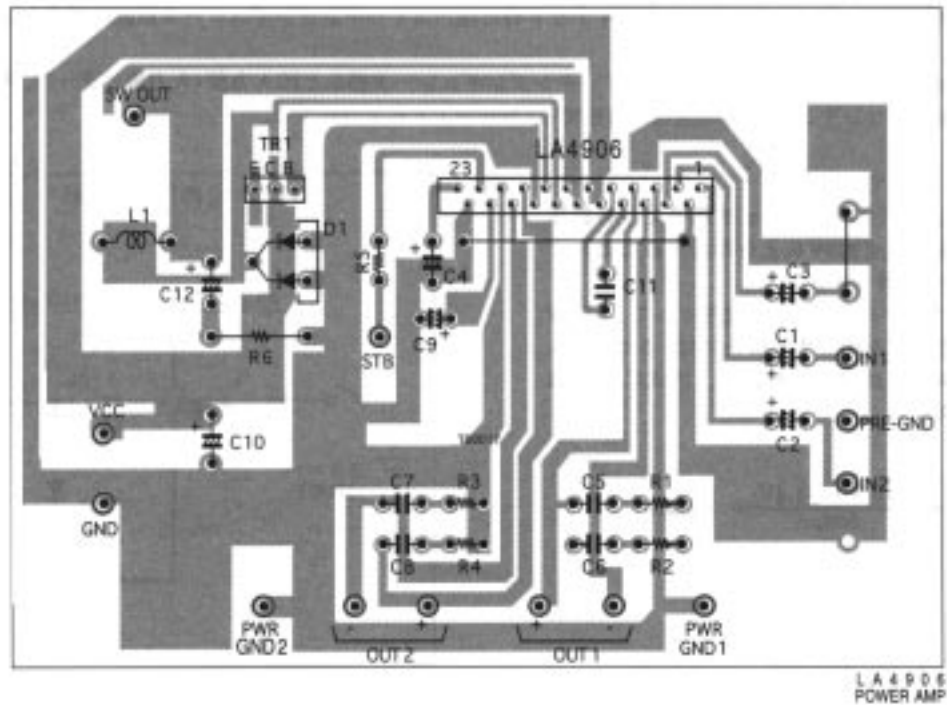
Pin Voltages (At  $V_{CC} = 13.2\text{ V}$ , with  $5\text{ V}$  applied to STBY through a  $10\text{ k}\Omega$  resistor, using a digital voltmeter)

Pin No.	1	2	3	4	5	6	7	8
Pin	IN2	Pre - GND	IN1	BEEP	PWR - GND 1	-OUT1	+OUT1	C
Pin voltage (V)	1.36	0	1.36	1.36	0	2.03	2.03	13.0

Pin No.	9	10	11	12	13	14	15	16
Pin	C	$V_{CC}$	$V_{CC}$ (SW)	SW OUT1	SW OUT2	SW E	SE B	SW - GND
Pin voltage (V)	3.92	13.2	13.2	3.70	3.70	3.73	4.0	0

Pin No.	17	18	19	20	21	22	23	
Pin	+OUT2	-OUT2	PWR - GND2	D. C	STAND-BY	DDL OUT	ON-TIME	
Pin voltage (V)	2.03	2.03	0	12.1	3.21	0	2.81	

## Sample Printed Circuit Board



## 1. External component descriptions

## C1 and C2

- Input capacitors. A value of 2.2  $\mu\text{F}$  is recommended for these capacitors. Note that the low-frequency area characteristics can be adjusted by changing  $f_L$ , which is determined by the values of C1 and C2. However, due to impulse (pop) noise considerations, the value of C1 and C2 should not exceed 3.3  $\mu\text{F}$  when C4 is 22  $\mu\text{F}$ .

## C3

- Beep amplifier input capacitor. A value the same as that of C1 and C2 is used. If the beep function is not used, connect the beep input to PRE-GND through C3.

## C4

- Set the amplifier turn-on time. A value of 22  $\mu\text{F}$  is recommended. (This will result in a turn-on time of about 0.7 second.) The on time is proportional to the value of this capacitor, and any value may be used. However, due to impulse (pop) noise considerations, a value of 22  $\mu\text{F}$  or larger should be used.

## C5, C6, C7, and C8

- Oscillation prevention capacitors. Polyester film (Mylar) capacitors with good temperature characteristics must be used. (These are used together with R1, R2, R3, and R4.) We recommend values of 0.1  $\mu\text{F}$  or higher for these capacitors since the stability will differ somewhat depending on the printed circuit board layout actually used.

## C9

- Decoupling capacitor (ripple filter)

## C10

- Power-supply capacitor

## C11

- Oscillation prevention capacitor for the switching regulator. A value of 1500 pF is recommended.

## C12

- Switching regulator output smoothing capacitor. The LA4906 adopts a self-excited switching regulator technique. The value of this capacitor must be optimized, since it influences both the self-excitation stability and the regulator efficiency. We recommend using a 2.2- $\mu\text{F}$  25-V OS (Organic Semiconductor) capacitor with a low series resistance and good temperature characteristics. Note that for the same reason a 2.2- $\Omega$  1/2-W resistor should be used for the associated resistor R6.

## R5

- Standby switch current limiter resistor. A value of 10 k $\Omega$  is recommended. (When the voltage applied to the standby switch is in the range 3 to 13.2 V.) Note that this resistor cannot be removed from this circuit.

See the “Standby Function” section elsewhere in this document.

TR1

- External switching transistor. The 2SD1668 (rank S) is recommended.  
If the application supports a load resistance  $R_L$  of 4  $\Omega$ , a 2SD1667 (rank S) may be used. A heat sink must be provided for this transistor, as well as for the IC itself.

D1

- Flywheel diode used to absorb energy from the coil. The SB40-05J, which is a Schottky barrier diode with a low  $V_F$ , is recommended.  
If the application supports a load resistance  $R_L$  of 4  $\Omega$ , an SB10-05A2 may be used. No heat sink is necessary for this diode, as well as for the IC itself.

L1

- The Tokin Co., Ltd.-made HP-022Z [180  $\mu$ H] (or the HP-011Z [200  $\mu$ H] for 4- $\Omega$  applications) is recommended.

2. IC internal characteristics and other notes

Switching regulator

- The LA4906 includes a signal-following self-excited switching regulator to reduce power dissipation. The self-excitation frequency with no input signal is about 100 kHz.
- To avoid spurious signal interference within the end product case, it is desirable to separate the tuner block from the amplifier block by as far as possible. When designing the printed circuit board pattern, make the lines associated with the switching regulator external components as short and as wide as possible.
- To prevent degradation of the LA4906 characteristics, separate the switching regulator external components from the IC inputs (the input block pattern, the input capacitors, and the beep amplifier capacitor) by at least 1.5 cm.

Standby function

- Pin 21 is the standby switching pin. The amplifier is turned on by applying a voltage of over 3 V to pin 21 through an external resistor (R1).
- If the standby switch applied voltage will exceed 13.2 V, then the current flowing into pin 5 must be held to under 500  $\mu$ A. Use the following formula to determine the value of R1 that meets this condition.

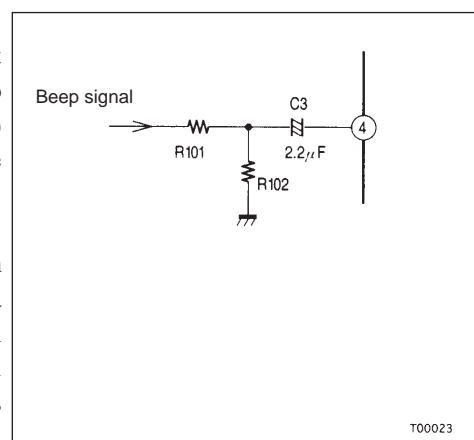
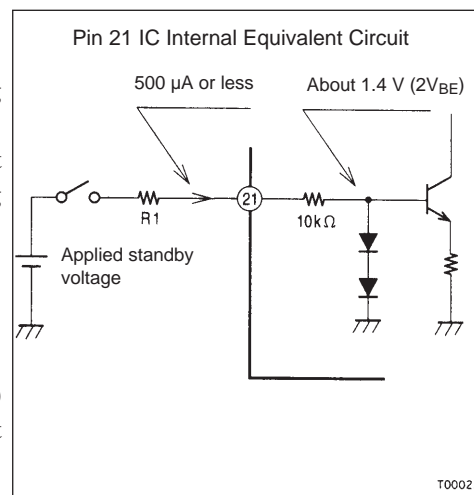
$$R1 = \frac{\text{applied voltage} - 1.4 \text{ V}}{500 \mu\text{A}} - 10 \text{ k}\Omega$$

BEEP pin (pin 4)

- If the BEEP pin is used, use the smallest value of R102 (see figure) possible (but note that this value must be under 100  $\Omega$ ) to prevent degradation of the IC's output noise voltage ( $V_{NO}$ ) characteristics.

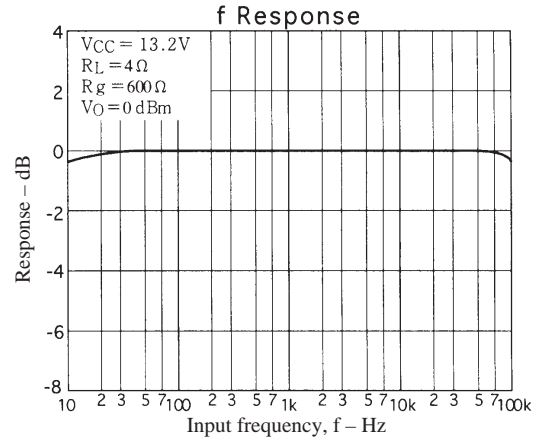
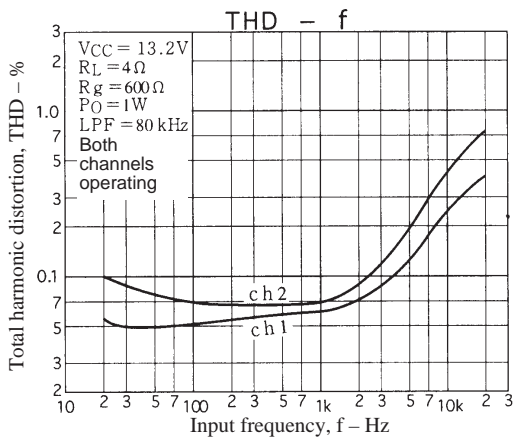
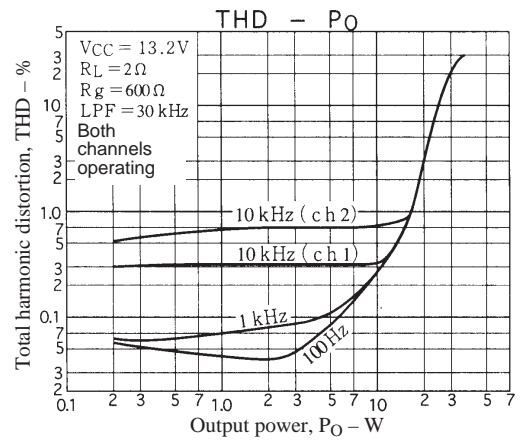
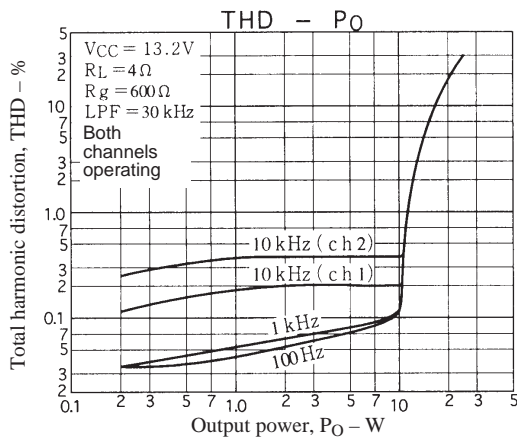
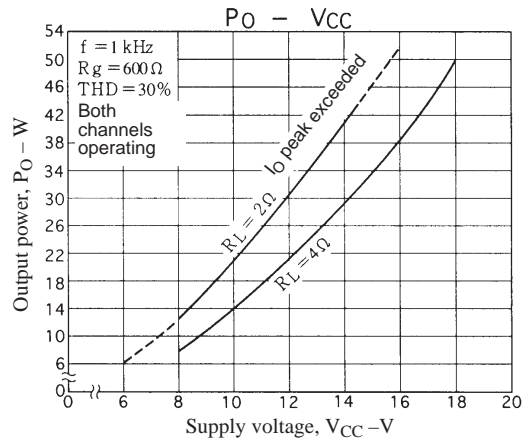
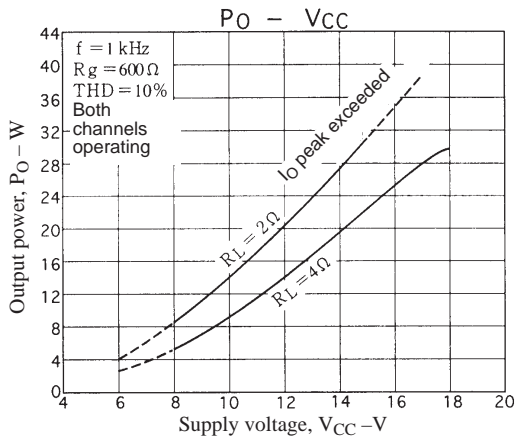
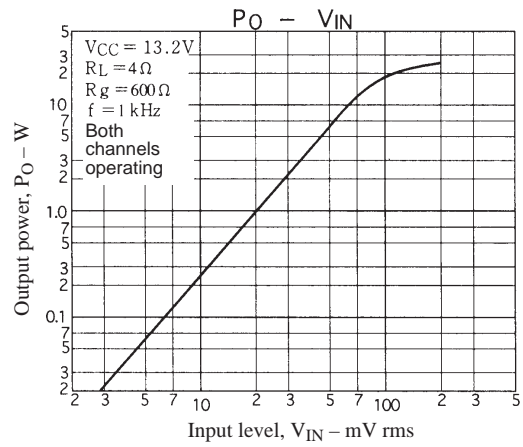
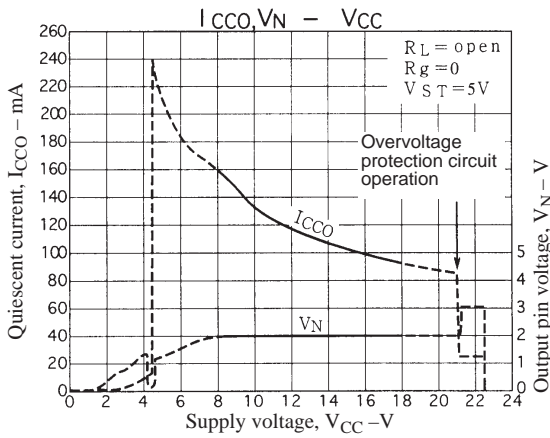
Protection circuits

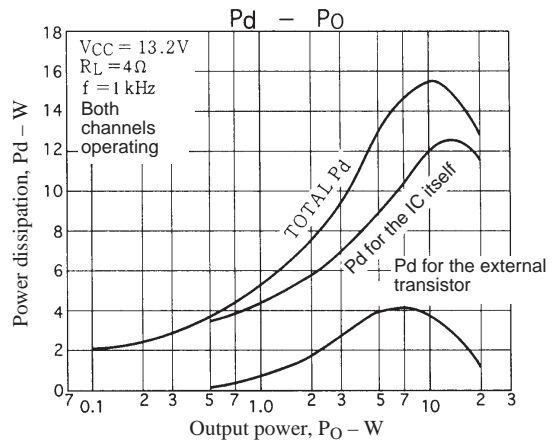
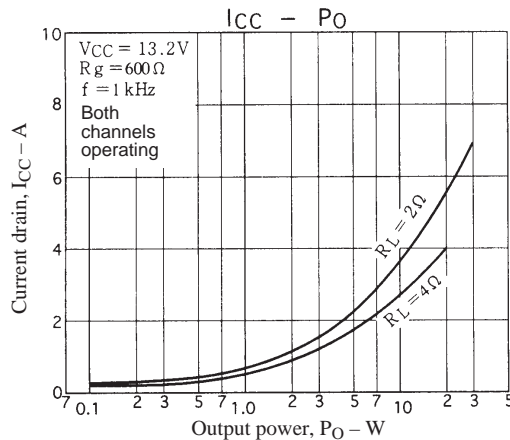
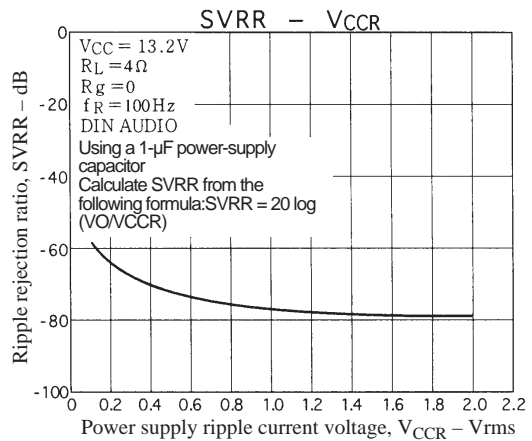
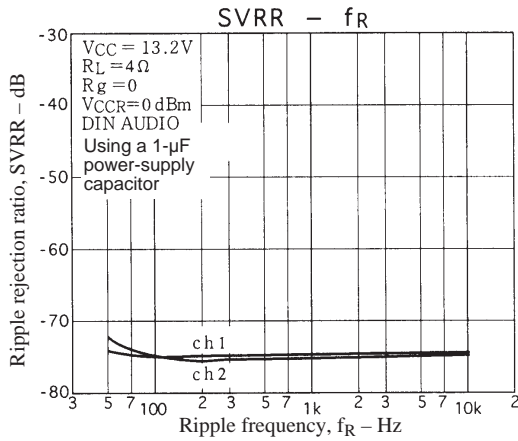
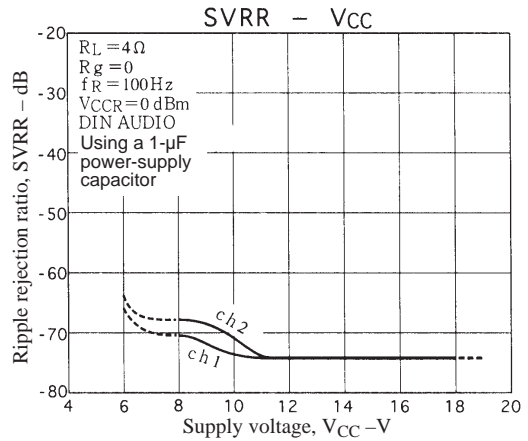
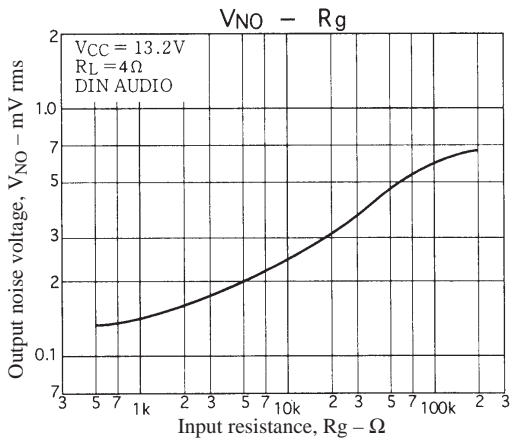
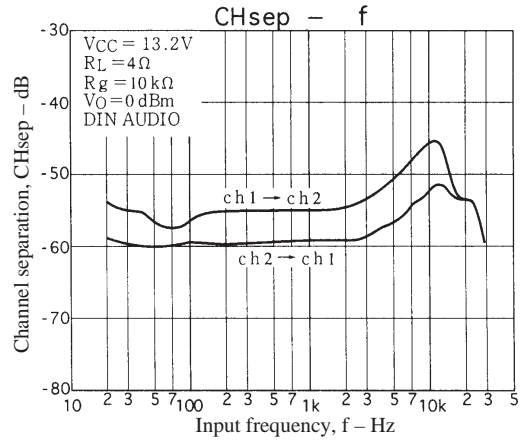
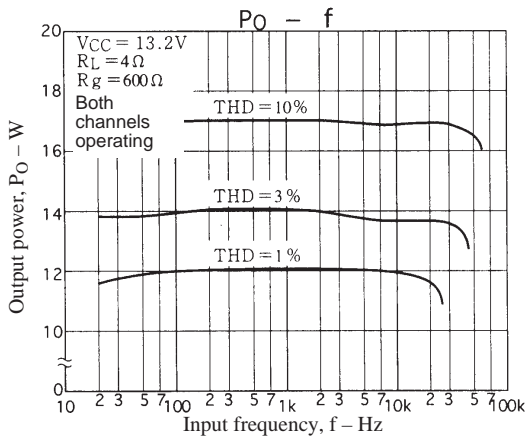
- The LA4906 includes an on-chip thermal protection circuit to prevent destruction of or damage to the IC if abnormal heating occurs. If, due to an inadequate heat sink or other reason, the IC junction temperature ( $T_j$ ) reaches or exceeds 160°C, the output is gradually attenuated by the operation of the thermal protection circuit.
- The overvoltage protection circuit operates if the  $V_{CC}$  voltage exceeds 20 V.
- While the LA4906 includes a power supply/ground short protection circuit, it does not include a load shorting protection circuit. The idea behind this design is that the thermal shutdown protection circuit will protect the IC itself if the load is shorted. However, since a load short will also cause temperature increases in the external transistor and coil, care is required in handling this case.



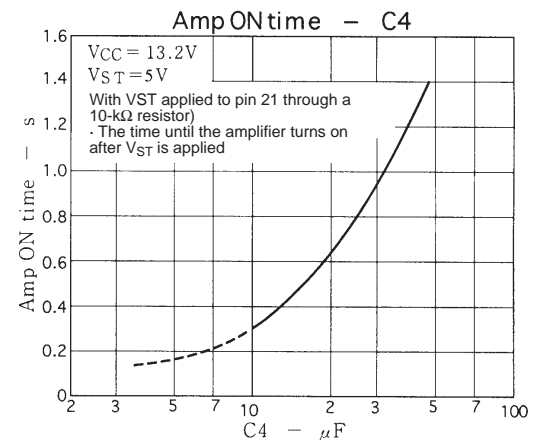
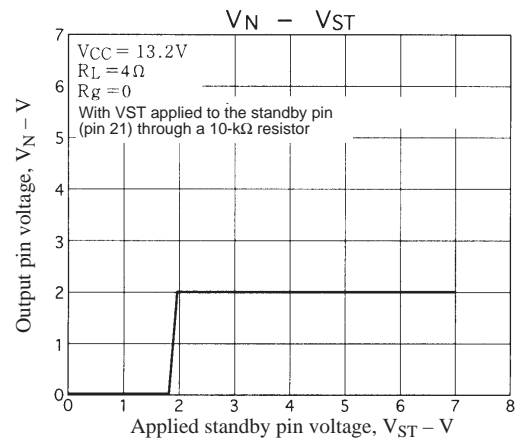
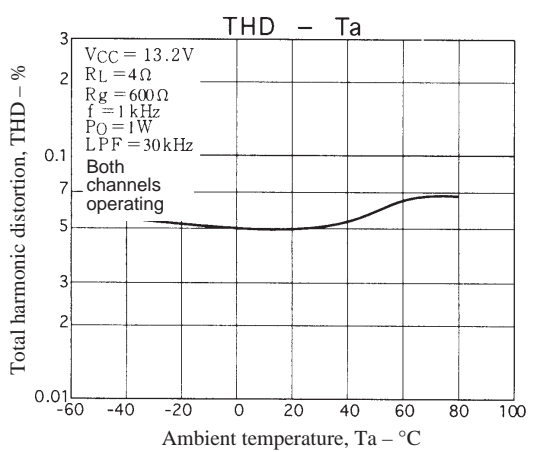
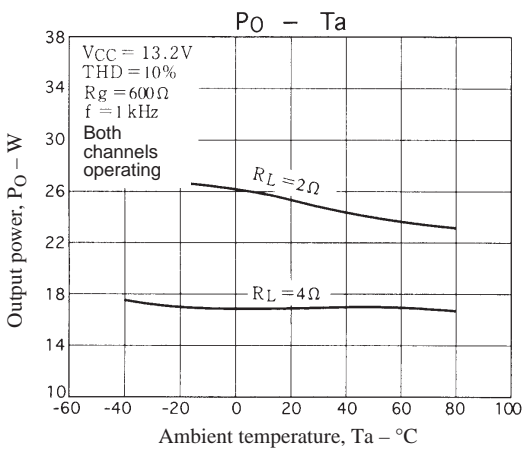
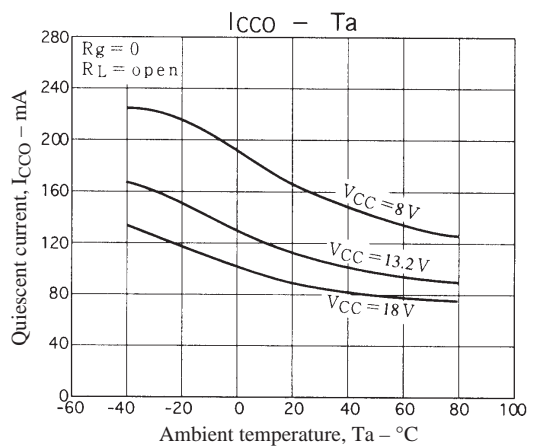
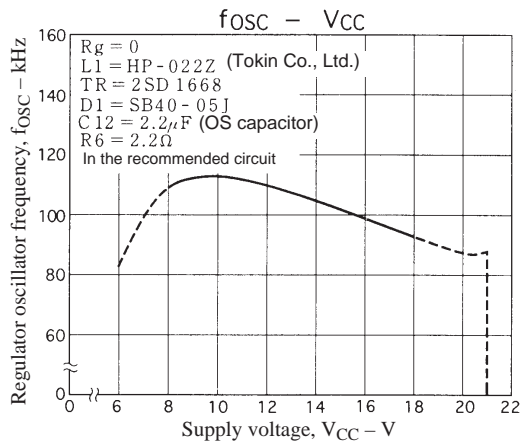
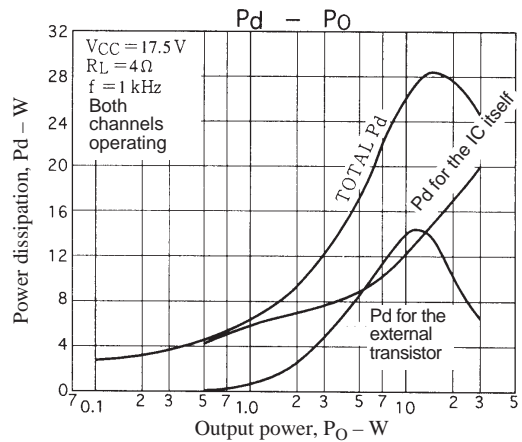
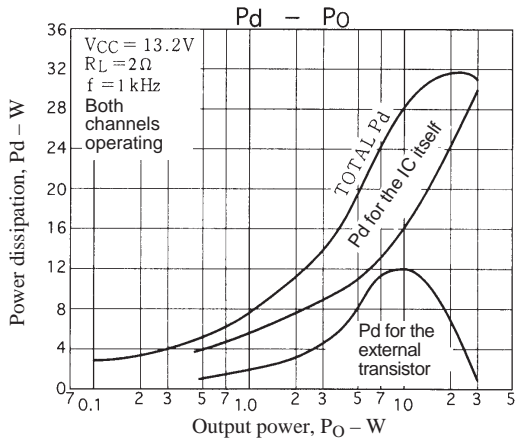
Other notes

- Pin 22 is not connected electrically to any other points within the package.









- Specifications of any and all SANYO products described or contained herein stipulate the performance, characteristics, and functions of the described products in the independent state, and are not guarantees of the performance, characteristics, and functions of the described products as mounted in the customer's products or equipment. To verify symptoms and states that cannot be evaluated in an independent device, the customer should always evaluate and test devices mounted in the customer's products or equipment.
- SANYO Electric Co., Ltd. strives to supply high-quality high-reliability products. However, any and all semiconductor products fail with some probability. It is possible that these probabilistic failures could give rise to accidents or events that could endanger human lives, that could give rise to smoke or fire, or that could cause damage to other property. When designing equipment, adopt safety measures so that these kinds of accidents or events cannot occur. Such measures include but are not limited to protective circuits and error prevention circuits for safe design, redundant design, and structural design.
- In the event that any or all SANYO products (including technical data, services) described or contained herein are controlled under any of applicable local export control laws and regulations, such products must not be exported without obtaining the export license from the authorities concerned in accordance with the above law.
- No part of this publication may be reproduced or transmitted in any form or by any means, electronic or mechanical, including photocopying and recording, or any information storage or retrieval system, or otherwise, without the prior written permission of SANYO Electric Co., Ltd.
- Any and all information described or contained herein are subject to change without notice due to product/technology improvement, etc. When designing equipment, refer to the "Delivery Specification" for the SANYO product that you intend to use.
- Information (including circuit diagrams and circuit parameters) herein is for example only; it is not guaranteed for volume production. SANYO believes information herein is accurate and reliable, but no guarantees are made or implied regarding its use or any infringements of intellectual property rights or other rights of third parties.

This catalog provides information as of April, 2000. Specifications and information herein are subject to change without notice.