



# LA6516

## Two-Output Power Amplifier

### Overview

The LA6516 is a two-output power amplifier developed for use in both consumer and industrial equipment.

### Functions

- High slew rate (1.0 V/μs)
- High output current (I<sub>O</sub> max = 1.0 A)
- Current limiter function
- Wide operating voltage range (±2 to 18 V)
- Supports single-voltage power supply operation (4 to 36 V)
- Thermal shutdown function
- Muting circuit (Functions for both channels; when the mute input is high the output will be on.)

### Package Dimensions

unit: mm

3046B-SIP10F

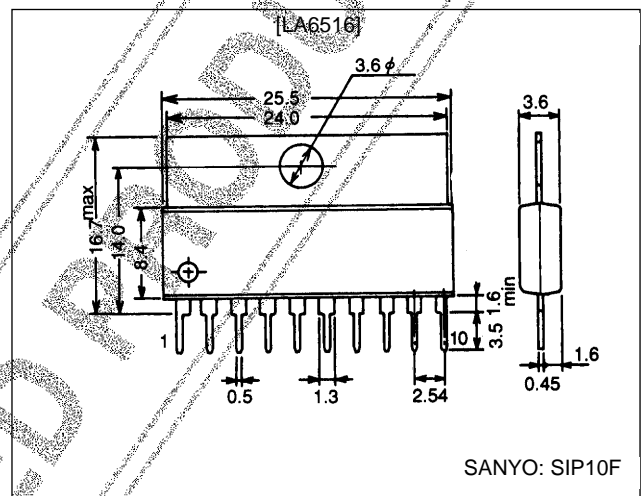

SANYO: SIP10F

### Specifications

#### Absolute Maximum Ratings at Ta = 25°C

Parameter	Symbol	Conditions	Ratings	Unit
Maximum supply voltage	V <sub>CC</sub> /V <sub>EE</sub>		±18	V
Input voltage	V <sub>IN</sub>		±17	V
Allowable power dissipation	P <sub>d</sub> max		2.5	W
Operating temperature	T <sub>opr</sub>		-20 to +75	°C
Storage temperature	T <sub>stg</sub>		-40 to +150	°C

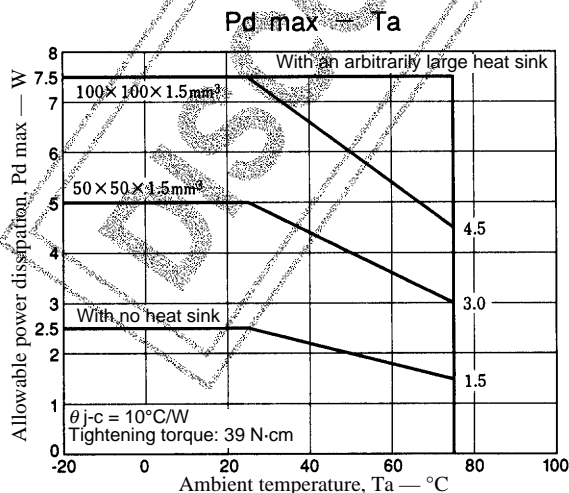

## LA6516

### Electrical Characteristics at $T_a = 25^\circ\text{C}$ , $V_{CC} = 10\text{ V}$ , $V_{EE} = -10\text{ V}$

Parameter	Symbol	Conditions	Ratings			Unit
			min	typ	max	
Quiescent current	$I_{CC}$	Mute off		10	30	mA
Input offset voltage	$V_{IO}$	$V_{CC}/V_{EE} = \pm 15\text{ V}$		2	7	mV
Input offset current	$I_{IO}$			10	100	nA
Input bias current	$I_B$			50	300	nA
Common-mode input voltage range	$V_{ICM}$		-9		+8	V
Common-mode rejection ratio	CMRR	$V_{IN} = 15\text{ V}_{p-p}$		75		dB
Supply voltage rejection ratio	SVRR	$V_{CC}/V_{EE} = \pm 5\text{ V}, 15\text{ V}$		30		$\mu\text{V/V}$
Voltage gain	$V_{GO}$			80		dB
Maximum output voltage	$V_{O1}$	$R_L = 33\ \Omega$		$\pm 8$		V
	$V_{O2}$	$R_L = 8\ \Omega$	$\pm 5.6$	$\pm 6$		V
Slew rate	SR	$R_L = 2\ \text{k}\Omega$		7		$\text{V}/\mu\text{S}$
Limit current	$I_{LIMIT}$			7		A
Muting on voltage	$V_{MUTE\ ON}$	$V_{MREF} = 0.0\text{ V}$	0.5	1.0		V
Muting off voltage	$V_{MUTE\ OFF}$	$V_{MREF} = 0.0\text{ V}$		1.0	2.0	V
Offset voltage temperature coefficient	$\Delta V_{IO}/\Delta T$	$T_a = -20\text{ to }+75^\circ\text{C}$		25		$\mu\text{V}/^\circ\text{C}$

### Pin Assignment

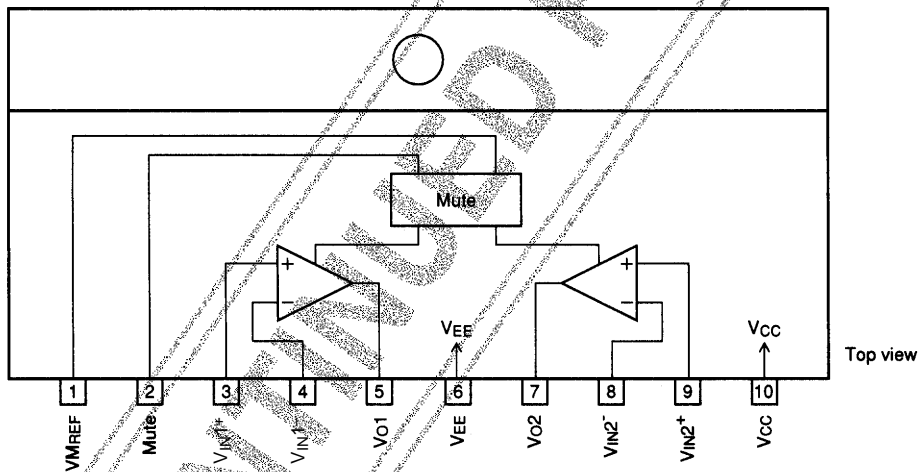

### Pin Functions

Pin No.	Pin	Item	Function
1	$V_{MREF}$		Muting on/off reference voltage input
2	MUTE	MUTE	Muting on/off signal input. Muting is activated when the MUTE pin voltage is less than the $V_{MREF}$ pin voltage plus 1.2 V (typ).
3	$V_{IN1+}$	AMP1	Amplifier 1 noninverting input
4	$V_{IN1-}$		Amplifier 1 inverting input
5	$V_{O1}$		Amplifier 1 output
6	$V_{EE}$	Negative power supply	Negative power supply ( $-2.0$ to $-18.0\text{ V}$ )
7	$V_{O2}$	AMP2	Amplifier 2 output
8	$V_{IN2-}$		Amplifier 2 inverting input
9	$V_{IN2+}$		Amplifier 2 noninverting input
10	$V_{CC}$	Positive power supply	Positive power supply ( $+2.0$ to $+18.0\text{ V}$ )

Test Circuits

•  $I_{CC}$

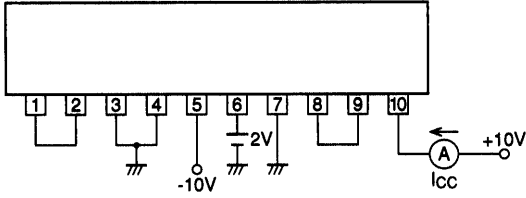

•  $V_{IO}$  SVRR

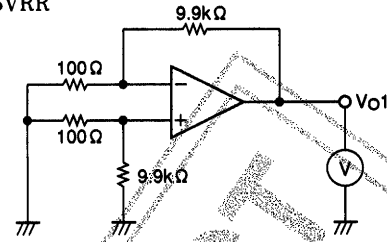

• For  $V_{IO}$   
 $V_{CC}/V_{EE} = \pm 15V$   
 $V_{IO} = V_{O1}/100$

• For SVRR  
 $V_{CC}/V_{EE} = \pm 5V, \pm 15V$   
 $SVRR = \frac{\Delta V_{O1}}{100 \times 10V}$

•  $I_{IO}$

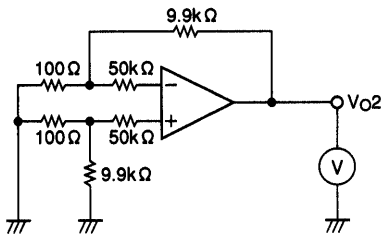

$$I_{IO} = \frac{|V_{O2} - V_{O1}|}{50k \times 100}$$

•  $I_{B^-}$

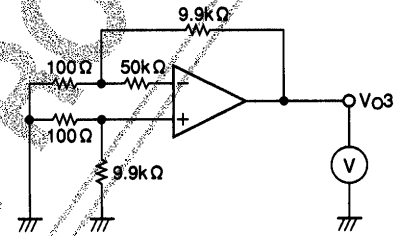

$$I_{B^-} = \frac{|V_{O3} - V_{O1}|}{50k \times 100}$$

•  $I_{B^+}$

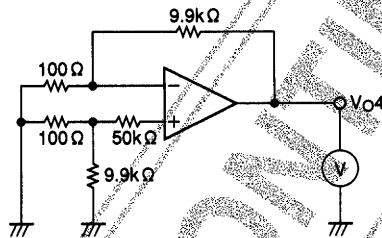

$$I_{B^+} = \frac{|V_{O4} - V_{O1}|}{50k \times 100}$$

•  $V_{ICM}$

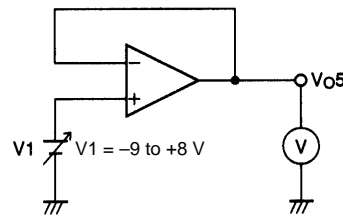

• CMRR

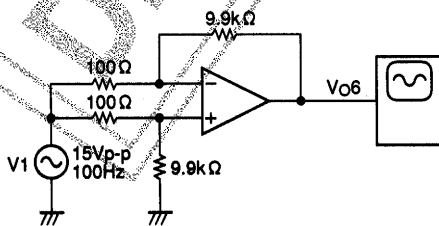

$$CMRR = 20 \log \frac{15 \times 100}{|\Delta V_{O6}|}$$

•  $I_{sc}$

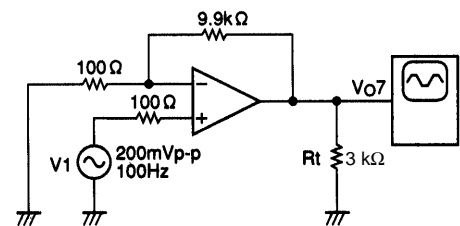

•  $V_{CC}/V_{EE} = \pm 14V$   
 •  $I_{sc} = V_{O7}/10$

Continued on next page.

Continued from preceding page.

•  $V_O$

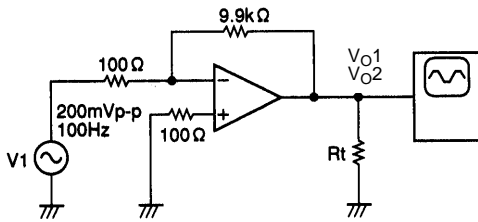

- For  $V_{O1}$ :  $R_L = 33 \Omega$
- For  $V_{O2}$ :  $R_L = 8 \Omega$

• SR

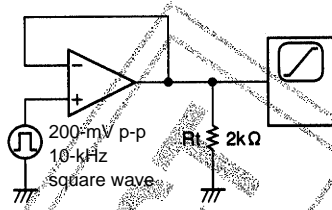

•  $V_{th ON}, V_{th OFF}$

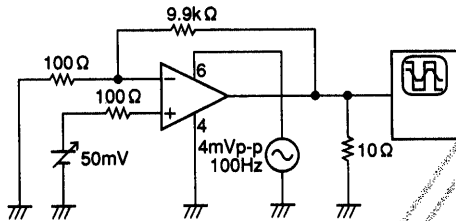

- No products described or contained herein are intended for use in surgical implants, life-support systems, aerospace equipment, nuclear power control systems, vehicles, disaster/crime-prevention equipment and the like, the failure of which may directly or indirectly cause injury, death or property loss.
- Anyone purchasing any products described or contained herein for an above-mentioned use shall:
  - ① Accept full responsibility and indemnify and defend SANYO ELECTRIC CO., LTD., its affiliates, subsidiaries and distributors and all their officers and employees, jointly and severally, against any and all claims and litigation and all damages, cost and expenses associated with such use:
  - ② Not impose any responsibility for any fault or negligence which may be cited in any such claim or litigation on SANYO ELECTRIC CO., LTD., its affiliates, subsidiaries and distributors or any of their officers and employees jointly or severally.
- Information (including circuit diagrams and circuit parameters) herein is for example only; it is not guaranteed for volume production. SANYO believes information herein is accurate and reliable, but no guarantees are made or implied regarding its use or any infringements of intellectual property rights or other rights of third parties.

This catalog provides information as of September, 1997. Specifications and information herein are subject to change without notice.