



LA70001, 70001M

Record/Playback Amplifiers for VHS Format VCRs

Overview

The LA70001 and LA70001M ICs provide record and playback amplifiers for VHS format VCRs. A system with an adjustment-free Y/C record current can be achieved by combining the LA70001/M with an LA71000M or LA71500M video signal processing IC.

Features

- Direct connection of the head to the playback amplifier input allows the number of external devices to be reduced.
- A fixed-current drive technique that is strongly resistant to load fluctuations is adopted in the record amplifier for stable recording characteristics. The record amplifier includes a built-in AGC circuit.
- These products have the same package dimensions as the LA70011 and LA70011M to allow a common PCB to be used. These products can also share the same PCB with the LA70020 by mounting the IC at the right end of the LA70020 socket.

Specifications

Maximum Ratings at $T_a = 25^\circ\text{C}$

Parameter	Symbol	Conditions	Ratings	Unit
Maximum supply voltage	$V_{CC \text{ max}}$		7.0	V
Allowable power dissipation	$P_{d \text{ max}}$	$T_a \leq 65^\circ\text{C}$ [LA70001]	600	mW
		$T_a \leq 65^\circ\text{C}$ [LA70001M] (Using a $114.3 \times 76.1 \times 1.6$ mm glass epoxy PCB)	500	mW
Operating temperature	T_{opr}		-10 to +65	$^\circ\text{C}$
Storage temperature	T_{stg}		-40 to +150	$^\circ\text{C}$

Operating Conditions at $T_a = 25^\circ\text{C}$

Parameter	Symbol	Conditions	Ratings	Unit
Recommended supply voltage	V_{CC}		5.0	V
Operating supply voltage range	$V_{CC \text{ op}}$		4.8 to 5.5	V

Package Dimensions

unit: mm

3067-DIP24S

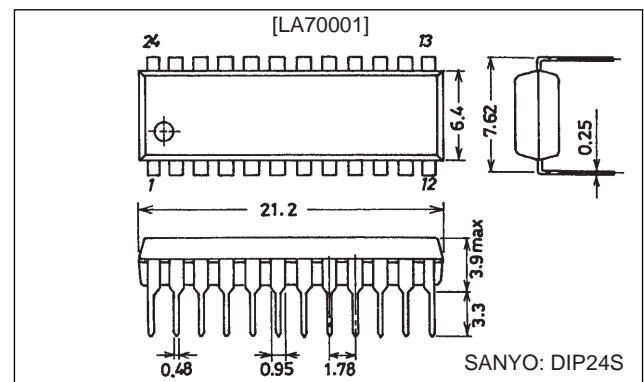

unit: mm

3112-MFP24S

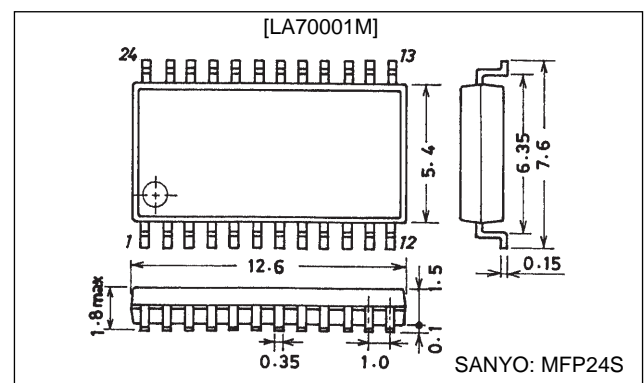

LA70001, 70001M

Electrical Characteristics at Ta = 25°C

Parameter	Symbol	Conditions	Ratings			Unit
			min	typ	max	
[Playback Mode]						
Current drain	I_{CCP}	The pin 13 inflow current.	23	29	35	mA
Voltage gain	CH1 G_{VP1}	$V_{IN} = 38 \text{ mVp-p}$, $f = 1 \text{ MHz}$	56	59	62	dB
	CH2 G_{VP2}		56	59	62	
Voltage gain difference 1	ΔG_{VP1}	$G_{VP1} - G_{VP2}$	-1	0	+1	dB
Equivalent input noise voltage	CH1 CH2 V_{NIN1} V_{NIN2}	With the same conditions as for the voltage gain, the ratio of the output passed through a 1.1-MHz low-pass filter and the output with no input signal.		1.0	1.5	μVrms
Frequency characteristics	CH1 CH2 ΔV_{fp1} ΔV_{fp2}	The ratio of the output for $V_{IN} = 38 \text{ mVp-p}$, $f = 7 \text{ MHz}$ and G_{VP1} , 2, 3, and 4.	-2.5	0		dB
Second harmonic distortion	CH1 CH2 V_{HDP1} V_{HDP2}	With $V_{IN} = 38 \text{ mVp-p}$, $f = 4 \text{ MHz}$, the ratio of the 8-MHz output component (second harmonic) and the 4-MHz component (the fundamental).		-40	-35	dB
Maximum output level	CH1 CH2 V_{OMP1} V_{OMP2}	At $f = 1 \text{ MHz}$, the output level when the ratio of the 3-MHz output (third harmonic) and the 1-MHz output (fundamental) is -30 dB.	1.0	1.2		Vp-p
Crosstalk SP	V_{CR1}	The ratio of the $V_{IN} = 38 \text{ mVp-p}$, $f = 4 \text{ MHz}$ output and G_{VP1} .		-40	-35	dB
Output DC offset	ΔV_{ODC1}	CH1 - CH2	-100	0	+100	mV
Envelope detector output pin voltage	V_{ENV}	The T6 DC level when there is no input signal.	0	0.8	1.3	V
Envelope detector output pin voltage SP1	V_{ENVSP1}	With a $f = 4 \text{ MHz}$ input, the T6 DC level when the T7A output level becomes 175 mVp-p.	2.0	2.5	3.0	V
	V_{ENVSP2}	With a $f = 4 \text{ MHz}$ input, the T6 DC level when the T7A output level becomes 400 mVp-p.	3.5	4.0	4.5	V
Envelope detector output pin voltage EP	V_{ENVEP1}	With a $f = 4 \text{ MHz}$ input, the T6 DC level when the T7A output level becomes 125 mVp-p.	2.0	2.5	3.0	V
	V_{ENVEP2}	With a $f = 4 \text{ MHz}$ input, the T6 DC level when the T7A output level becomes 300 mVp-p.	4.0	4.5	5.0	V
Switch transistor on resistance in playback mode	R_{PON18}	Measure the difference in the DC levels with a 1-mA and a 2-mA inflow current.		4	6	Ω
SW30 threshold level	SW30-1	Lch \rightarrow Hch *1	1.2		5.0	V
	SW30-2	Hch \rightarrow Lch	0.0		0.8	V
[Record Mode]						
Current drain	I_{CCR}	The pin 13 inflow current.	43	50	57	mA
Record AGC amplifier output level	V_{RSP}	The output level when $V_{IN} = 400 \text{ mVp-p}$, $f = 4 \text{ MHz}$.	105	112	119	mVp-p
Record AGC amplifier control characteristics	$\Delta V_{AGC1-SP}$	At $f = 4 \text{ MHz}$, when $V_{IN} = 700 \text{ mVp-p}$: the output level /VRSP, EP		0.5	1.0	dB
	$\Delta V_{AGC2-SP}$	At $f = 4 \text{ MHz}$, when $V_{IN} = 100 \text{ mVp-p}$: the output level /VRSP, EP	-1.0	-0.5		dB
Record AGC amplifier frequency characteristics	ΔV_{FRS}	At $V_{IN} = 400 \text{ mVp-p}$, the ratio of the outputs when f is 1 MHz and 7 MHz, i.e. the ratio of the 7-MHz value to the 1-MHz value.*2.	-1	0	+1	dB
Record AGC amplifier second harmonic distortion	ΔV_{HDRS}	With $V_{IN} = 400 \text{ mVp-p}$, $f = 4 \text{ MHz}$, the ratio of the 8-MHz output component (second harmonic) and the 4-MHz component (the fundamental).		-45	-40	dB
Record AGC amplifier maximum output level	ΔV_{MOSP}	At $f = 4 \text{ MHz}$, the output level at which the second harmonic goes to -35 dB. *3	20	22		mAp-p
Record AGC amplifier muting attenuation	ΔV_{MRS}	When $V_{IN} = 400 \text{ mVp-p}$ and $f = 4 \text{ MHz}$, the output level /VRSP, EP		-45	-40	dB
Record AGC amplifier cross modulation relative level	ΔV_{CYS}	T9A: $V_{IN} = 400 \text{ mVp-p}$, $f = 4 \text{ MHz}$ T10A: $V_{IN} = 2.4 \text{ Vp-p}$, $f = 629 \text{ kHz}$ The ratio of the (4 MHz \pm 629 kHz) and the 4-MHz outputs.		-45	-40	dB
Record muting threshold level	MUTE-1	MUTE OFF \rightarrow MUTE ON *1	1.2		2.8	V
	MUTE-2	MUTE ON \rightarrow MUTE OFF	3.2		5.0	V
Record mode to playback mode threshold level	PB-REC	PB \rightarrow REC *1	1.2		5.0	V
	REC-PB	REC \rightarrow PB	0.0		0.8	V

Notes: Use a resistor with an accuracy of 1.0% for the resistor between pins 13 and 14.

*1. This is the voltage application point

*2. Here, fix the AGC amplifier gain by applying a 1.8-V DC level to the AGC detector filter pin (pin 15).

*3. Here, adjust the output level by applying a DC voltage to the REC-CUR-Adj pin (pin 12).

LA70001, 7001M

Pin Functions

Pin No.	Pin name	Standard DC voltage (V)		Equivalent circuit	Notes			
1	N.C							
2	N.C							
3	HA (EP/SP)			<p>A09396</p>	<table border="1"> <tr> <td>EP</td> <td rowspan="2">1.5 V</td> </tr> <tr> <td>SP</td> </tr> </table>	EP	1.5 V	SP
EP	1.5 V							
SP								
4	SW30			<p>A09397</p>	<table border="1"> <tr> <td>Hch</td> <td rowspan="2">1.0 V</td> </tr> <tr> <td>Lch</td> </tr> </table>	Hch	1.0 V	Lch
Hch	1.0 V							
Lch								
5	H-SYNC			<p>A09398</p>	<table border="1"> <tr> <td>SYNC H</td> <td rowspan="2">1.5 V</td> </tr> <tr> <td>L</td> </tr> </table>	SYNC H	1.5 V	L
SYNC H	1.5 V							
L								
6	ENVDET-OUT	PB	Provided in a separate document.	<p>A09399</p>				
		REC	0					
7	PB-OUT	PB	1.7	<p>A09400</p>				
		REC	2.1					
8 20	GND							

Continued on next page.

LA70001, 70001M

Continued from preceding page.

Pin No.	Pin name	Standard DC voltage (V)		Equivalent circuit	Notes						
9	REC-Y-IN	PB	4.0								
		REC	3.7								
10	REC-C-IN	PB	4.0								
		REC	3.7								
11	REC/MUTE/PB				<table border="1"> <tr> <td>REC</td> <td>3.0 V</td> </tr> <tr> <td>REC MUTE</td> <td>1.0 V</td> </tr> <tr> <td>PB</td> <td></td> </tr> </table>	REC	3.0 V	REC MUTE	1.0 V	PB	
REC	3.0 V										
REC MUTE	1.0 V										
PB											
12	REC-CURRENT-ADJ2	PB	2.5 V								
		REC	2.5 V								
13	V _{CC}										
14	REC-CURRENT-ADJ1	PB	5.0								
		REC	4.5								

Continued on next page.

LA70001, 70001M

Continued from preceding page.

Pin No.	Pin name	Standard DC voltage (V)		Equivalent circuit	Notes
15	REC-AGC-FILT	PB	0		
		REC	1.6		
16 19	L IN H IN	PB	2.1		
		REC	4.1		
17	REC_SP_OUT	PB	2.1 V		
		REC	4.1 V		
18	PB FILT	PB	0		
		REC	2.5		
21 22 23 24	N.C				

Usage Notes

Control Pin Logic

- HA-SW (EP/SP mode switching): pin 3

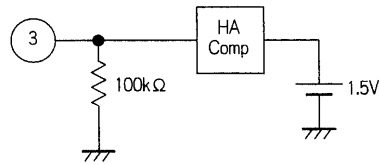

GND < the pin 3 DC level < 1.5 V: SP mode
1.5 V < the pin 3 DC level < 5 V: EP mode

A09410

- H.SYNC input: pin 5

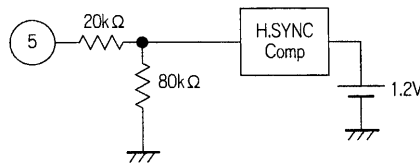

The pin 5 DC level > 1.5 V: The horizontal synchronization period

A09411

In record mode: Used as the REC-AGC-AMP synchronization block gate pulse.

- REC/REC-MUTE/PB switching: pin 11

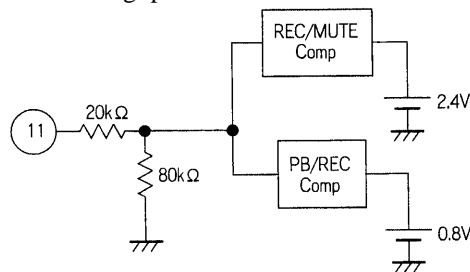

GND < the pin 11 DC level < 1.0 V: Playback mode
1.0 V < the pin 11 DC level < 3.0 V: Record mode with recording muted.
3.0 V < the pin 11 DC level < 5.0 V: Record mode

A09412

Envelope detection characteristics: pin 6

The LA70001 provides a built-in playback signal envelope detection circuit so that the tracking adjustment can be made automatic.

Envelope Detection Voltage Characteristics

The pin 6 detected DC level (V)

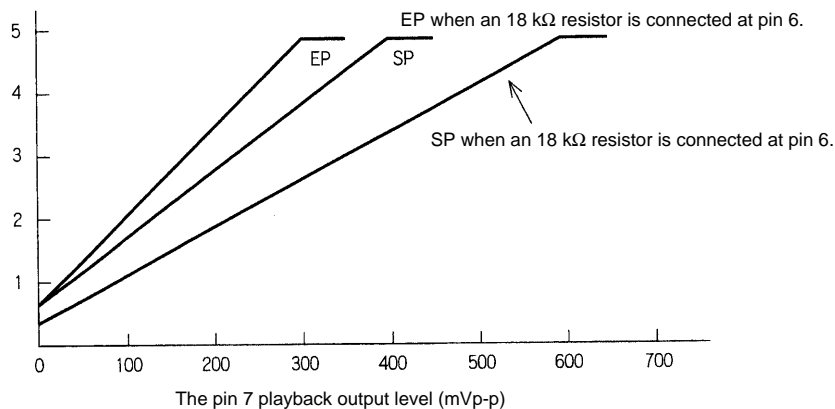

A09413

LA70001, 7001M

Record Amplifier Gain Control

The LA70001 achieves an adjustment-free record current by adding an AGC circuit in the record amplifier block. The record current can be modified using the following method.

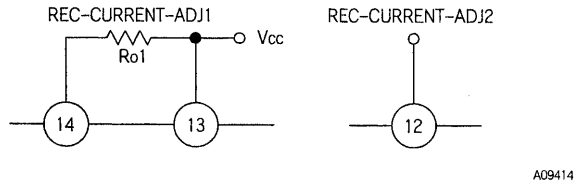

- Record current adjustment 2: When left open.
Pin 12 DC level is set to $1/2 V_{CC}$ (approximately 2.5 V) by an internal bias, and the record current is determined by R_{o1} .
Design value: When R_{o1} is 1.5 k Ω , the record current will be 12.7 mA per channel.
- Record current adjustment 2: When used.
The gain can be varied by -6.0 dB to $+3.5$ dB relative to the value set by R_{o1} by applying a control DC voltage of between 1 and 4 V to pin 12.

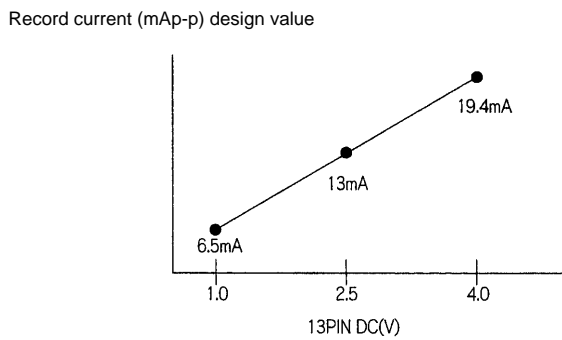

Note: The technique shown in the figure below can be used to apply a DC level to pin 12. This allows a control voltage of between 1 and 4 V to be applied.

