



SANYO Semiconductors

DATA SHEET

Monolithic Linear IC

An ON Semiconductor Company

LA73031V

For DVD Recorder

Video Signal Input Switch

Overview

This LA73031V is a video signal input switch for DVD recorder.

Functions

- Six input switches × one channel
- Five input switches × two channels
- Keyed clamp
- 6dB amplifier
- 6MHz low pass filter
- Video signal detection
- Composite sync output
- Standby mode

Specifications

Maximum Ratings at $T_a = 25^\circ\text{C}$

Parameter	Symbol	Conditions	Ratings	Unit
Maximum supply voltage	$V_{CC \text{ max}}$		7.0	V
Allowable power dissipation	$P_d \text{ max}$	$T_a \leq 75^\circ\text{C}^*$	780	mW
Operating temperature	T_{opr}		-20 to +75	$^\circ\text{C}$
Storage temperature	T_{stg}		-40 to +150	$^\circ\text{C}$

* When mounted on a $114.3 \times 76.1 \times 1.6 \text{ mm}^3$ glass epoxy resin.

Recommended Operating Conditions at $T_a = 25^\circ\text{C}$

Parameter	Symbol	Conditions	Ratings	Unit
Recommending operation voltage	V_{CC}		5.0	V
Operating voltage range	$V_{CC \text{ opr}}$		4.75 to 5.25	V
Input pin voltage application range	V_{IN}		-0.3 to $V_{CC \text{ opr}} + 0.3$	V

■ Any and all SANYO Semiconductor products described or contained herein do not have specifications that can handle applications that require extremely high levels of reliability, such as life-support systems, aircraft's control systems, or other applications whose failure can be reasonably expected to result in serious physical and/or material damage. Consult with your SANYO Semiconductor representative nearest you before using any SANYO Semiconductor products described or contained herein in such applications.

■ SANYO Semiconductor assumes no responsibility for equipment failures that result from using products at values that exceed, even momentarily, rated values (such as maximum ratings, operating condition ranges, or other parameters) listed in products specifications of any and all SANYO Semiconductor products described or contained herein.

SANYO Semiconductor Co., Ltd.

TOKYO OFFICE Tokyo Bldg., 1-10, 1 Chome, Ueno, Taito-ku, TOKYO, 110-8534 JAPAN

LA73031V

Electrical Characteristics at Ta = 25°C, VCCV = ±5.0V

Parameter	Symbol	Input signal				Output Point	Test Conditions	Ratings			Unit	Control Voltage Unit: V								
		Point	Signal	Freq [Hz]	Amplitude [p-p]			min	typ	max		V4	V7	V9	V17	V19	V21	V23	V25	V28
Current dissipation	I _{CC1}					V _{CC1} V _{CC2} V _{CC3} V _{CC4}	Measure the sum of currents flowing into V _{CC1} , V _{CC2} , V _{CC3} and V _{CC4} with no signal.	60	75	90	mA	0	0	5	5	0	0	0	0	0
Current dissipation at standby mode	I _{CC2}					V _{CC1} V _{CC2} V _{CC3} V _{CC4}	Measure the sum of currents flowing into V _{CC1} , V _{CC2} , V _{CC3} and V _{CC4} at standby mode.	7.5	9	10.5	mA								5	
Output level of composite	C40	V _{IN40}	SG1		1V	T38	Measure the output sync tip level at T38.	0.7	0.8	0.9	V	0	5	5	0	0	0	0	0	5
	C42	V _{IN42}	SG1		1V	T38		0.7	0.8	0.9	V	0	5	5	5	0	0	0	0	5
	C44	V _{IN44}	SG1		1V	T38		0.7	0.8	0.9	V	0	5	5	0	5	0	0	0	5
	C1	V _{IN1}	SG1		1V	T38		0.7	0.8	0.9	V	0	5	5	5	5	0	0	0	5
	C3	V _{IN3}	SG1		1V	T38		0.7	0.8	0.9	V	0	5	5	0	0	5	0	0	5
Output level of chroma	C8	V _{IN8}	SG2		714mV	T31	Measure the output center level at T31.	1.9	2.2	2.5	V	0	5	0	0	0	0	0	0	5
	C10	V _{IN10}	SG2		714mV	T31		1.9	2.2	2.5	V	0	5	0	5	0	0	0	0	5
	C12	V _{IN12}	SG2		714mV	T31		1.9	2.2	2.5	V	0	5	0	0	5	0	0	0	5
	C14	V _{IN14}	SG2		714mV	T31		1.9	2.2	2.5	V	0	5	0	5	5	0	0	0	5
	C16	V _{IN16}	SG2		714mV	T31		1.9	2.2	2.5	V	0	5	0	0	0	5	0	0	5
Output level of Y	C18	V _{IN18}	SG3		1V	T29	Measure the output sync tip level at T29.	0.7	0.8	0.9	V	0	5	0	0	0	0	0	0	5
	C20	V _{IN20}	SG3		1V	T29		0.7	0.8	0.9	V	0	5	0	5	0	0	0	0	5
	C22	V _{IN22}	SG3		1V	T29		0.7	0.8	0.9	V	0	5	0	0	5	0	0	0	5
	C24	V _{IN24}	SG3		1V	T29		0.7	0.8	0.9	V	0	5	0	5	5	0	0	0	5
	C26	V _{IN26}	SG3		1V	T29		0.7	0.8	0.9	V	0	5	0	0	0	5	0	0	5
Pedestal level of component output	PC38	V _{IN6}	SG4		1V	T38	Measure the output pedestal level at T38 and T29.	2.2	2.3	2.4	V	5	5	0	0	0	0	0	0	5
	PC31	V _{IN8}	SG4		1V	T31		2.2	2.3	2.4	V	5	5	0	0	0	0	0	0	5
		V _{IN18}	SG3		1V															
6dB amp gain	G40H	V _{IN40}	SG1	100k	1V	T38	Measure the gain to input of each output. 20log(V _{OUT} /V _{IN})	5.5	6	6.5	dB	0	5	5	0	0	0	0	0	5
	G8H	V _{IN8}	SG1	100k	714mV	T31		5.5	6	6.5	dB	0	5	0	0	0	0	0	0	5
	G18H	V _{IN18}	SG1	100k	1V	T29		5.5	6	6.5	dB	0	5	0	0	0	0	0	0	5
0dB amp gain	G40L	V _{IN40}	SG1	100k	1V	T38	Measure the gain to input of each output. 20log(V _{OUT} /V _{IN})	-0.5	0	0.5	dB	0	0	5	0	0	0	0	0	5
	G8L	V _{IN8}	SG1	100k	714mV	T31		-0.5	0	0.5	dB	0	0	0	0	0	0	0	0	5
	G18L	V _{IN18}	SG1	100k	1V	T29		-0.5	0	0.5	dB	0	0	0	0	0	0	0	0	5
Frequency characteristics in LPF-off	F40	V _{IN40}	SG1	10M	1V	T38	Ga-Gb	-0.5	0	0.5	dB	0	5	5	0	0	0	0	0	5
	F8	V _{IN8}	SG1	10M	714mV	T31	Ga=20log(V _{OUT} /V _{IN}) for 100kHz	-0.5	0	0.5	dB	0	5	0	0	0	0	0	0	5
	F18	V _{IN18}	SG1	10M	1V	T29	Gb=20log(V _{OUT} /V _{IN}) for 10MHz	-0.5	0	0.5	dB	0	5	0	0	0	0	0	0	5
Frequency characteristics in LPF-on1	F40LP1	V _{IN40}	SG1	6M	1V	T38	Ga-Gb	-3	-1	0.5	dB	0	5	5	0	0	0	0	0	0
	F8LP1	V _{IN8}	SG1	6M	714mV	T31	Ga=20log(V _{OUT} /V _{IN}) for 100kHz	-3	-1	0.5	dB	0	5	0	0	0	0	0	0	0
	F18LP1	V _{IN18}	SG1	6M	1V	T29	Gb=20log(V _{OUT} /V _{IN}) for 6MHz	-3	-1	0.5	dB	0	5	0	0	0	0	0	0	0

Continued on next page

LA73031V

Continued from preceding page.

Parameter	Symbol	Input signal				Output Point	Test Conditions	Ratings			Unit	Control Voltage Unit: V							
		Point	Signal	Freq [Hz]	Amplitude [p-p]			Min	Typ	Max		V4	V7	V9	V17	V19	V21	V23	V25
Frequency characteristics in LPF-on2	F40LP2	V _{IN40}	SG1	14.3M	1V	T38	Ga-Gb	-40	-30	dB	0	5	5	0	0	0	0	0	0
	F8LP2	V _{IN8}	SG1	14.3M	714mV	T31	Ga=20log(V _{OUT} /V _{IN}) for 100kHz	-40	-30	dB	0	5	0	0	0	0	0	0	0
	F18LP2	V _{IN18}	SG1	14.3M	1V	T29	Gb=20log(V _{OUT} /V _{IN}) for 14.3MHz	-40	-30	dB	0	5	0	0	0	0	0	0	0
Output 2nd order distortion	H40	V _{IN40}	SG1	5M	1V	T38	Measure the output 2nd harmonics component of 5MHz.	-45	-35	dB	0	5	5	0	0	0	0	0	0
	H8	V _{IN8}	SG1	5M	714mV	T31		-45	-35	dB	0	5	0	0	0	0	0	0	0
	H18	V _{IN18}	SG1	5M	1V	T29		-45	-35	dB	0	5	0	0	0	0	0	0	0
C.SYNC Separator output high level	CV40H	V _{IN40}	SG3		1V	T34	Measure the output high level at T34.	V _{CC} -0.5	V _{CC}	V	0		5	0	0	0	0	0	0
C.SYNC Separator output high level	CV40L	V _{IN40}	SG3		1V	T34	Measure the output low level at T34.	0	0.3	0.6	V	0		5	0	0	0	0	0
C.Sync separator output pulse delay time	CT40	V _{IN40}	SG3		1V	T34	Measure the pulse delay for input signal at T34.	0.85	1.2	1.6	μs	0		5	0	0	0	0	0
C.Sync separator output pulse width	CW40	V _{IN40}	SG3		1V	T34	Measure the pulse width at T34.	3.2	4.2	5.2	μs	0		5	0	0	0	0	0
V.Sync separator output high level	VV40H	V _{IN40}	SG6		1V	T36	Measure the output high level at T36.	V _{CC} -0.5	V _{CC}	V	0		5	0	0	0	0	0	0
V.Sync separator output low level	VV40L	V _{IN40}	SG6		1V	T36	Measure the output low level at T36.	0	0.3	0.6	V	0		5	0	0	0	0	0
V.Sync separator output pulse delay time	VT40	V _{IN40}	SG6		1V	T36	Measure the pulse delay for input signal at T36.	11	19	27	μs	0		5	0	0	0	0	0
V.Sync separator output pulse width	VW40	V _{IN40}	SG6		1V	T36	Measure the pulse width at T36.	150	190	240	μs	0		5	0	0	0	0	0
V-DET output high level	VDET40	V _{IN40}	SG1		1V	T43	Input signal	V _{CC} -0.5	V _{CC}	V	0		5	0	0	0	0	0	0
V-DET output low level						T43	No signal	0	0.3	0.6	V	0		5	0	0	0	0	0
DG	DGLP38	V _{IN40}	SG5	3.58M	1V	T38		-2	0	2	%	0	5	5	0	0	0	0	0
DP	DPLP38	V _{IN40}	SG5	3.58M	1V	T38		-1.5	0	1.5	deg	0	5	5	0	0	0	0	0
Crosstalk CVBS	CTCV	V _{IN40}	GND	5M	1V	T38		-60	-55	dB	0	5	5	0	0	0	0	0	0
		V _{IN42}	SG1																
Crosstalk C	CTC	V _{IN8}	GND	5M	714mV	T31		-60	-55	dB	0	5	0	0	0	0	0	0	0
		V _{IN10}	SG2																
Crosstalk Y	CTY	V _{IN18}	GND	5M	1V	T29		-60	-55	dB	0	5	0	0	0	0	0	0	0
		V _{IN20}	SG3																
Video S/N	SN40	V _{IN40}	SG3		1V	T38	BW = HPF100kHz, LPF5MHz 20log (noise/signal)	-65	-60	dB	0	5	5	0	0	0	0	0	0

LA73031V

Package Dimensions

unit : mm (typ)

3277

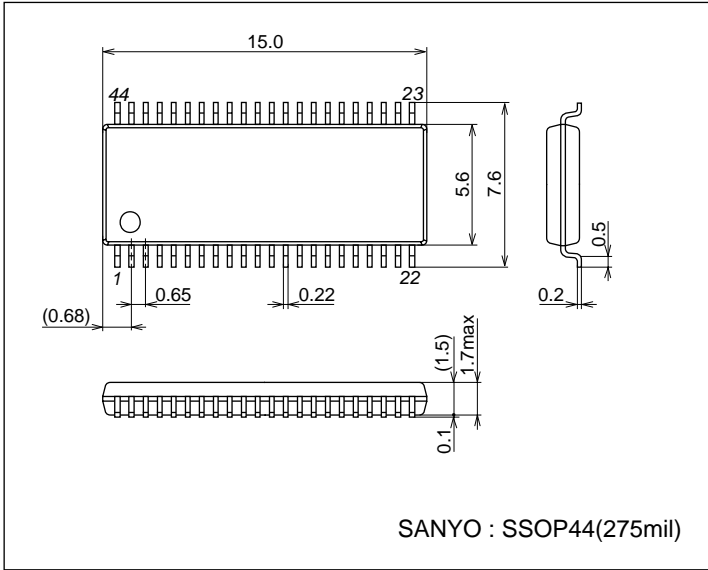

Control Specification

Pin control voltage Low level: 0 to 0.7V, High level: 2.6 to 5V

Input selection control

PIN21	PIN19	PIN17	PIN9	PIN4	PIN23	Output			
INSEL3	INSEL2	INSEL1	YOUTSEL	COMPONENT	Stand-by	CVBSOUT	Y OUT	C OUT	C.SYNC
L	L	L	L	L	L	CVBS1	Y1	C1	Y1
L	L	H	L	L	L	CVBS2	Y2	C2	Y2
L	H	L	L	L	L	CVBS3	Y3	C3	Y3
L	H	H	L	L	L	CVBS4	Y4	C4	Y4
H	L	L	L	L	L	CVBS5	Y5	C5	Y5
L	L	L	H	L	L	CVBS1	CVBS1	C1	CVBS1
L	L	H	H	L	L	CVBS2	CVBS2	C2	CVBS2
L	H	L	H	L	L	CVBS3	CVBS3	C3	CVBS3
L	H	H	H	L	L	CVBS4	CVBS4	C4	CVBS4
H	L	L	H	L	L	CVBS5	CVBS5	C5	CVBS5
				H	L	Cb	Y1	Cr (C1)	Y1
					H				CVBS2/Y2 (*1)

Other Controls

Pin No	Control item	L control	H control
7	Gain-CTL	0dB	6dB
28	LPF ON/OFF	ON	OFF

*1: At the time of standby, if a signal is in Y2, the sync of the signal of Y2 will be separated.

Standby mode

CVBS2	Y2	C.Sync output
Input	No Input	CVSB2
Input	Input	Y2
No Input	Input	Y2

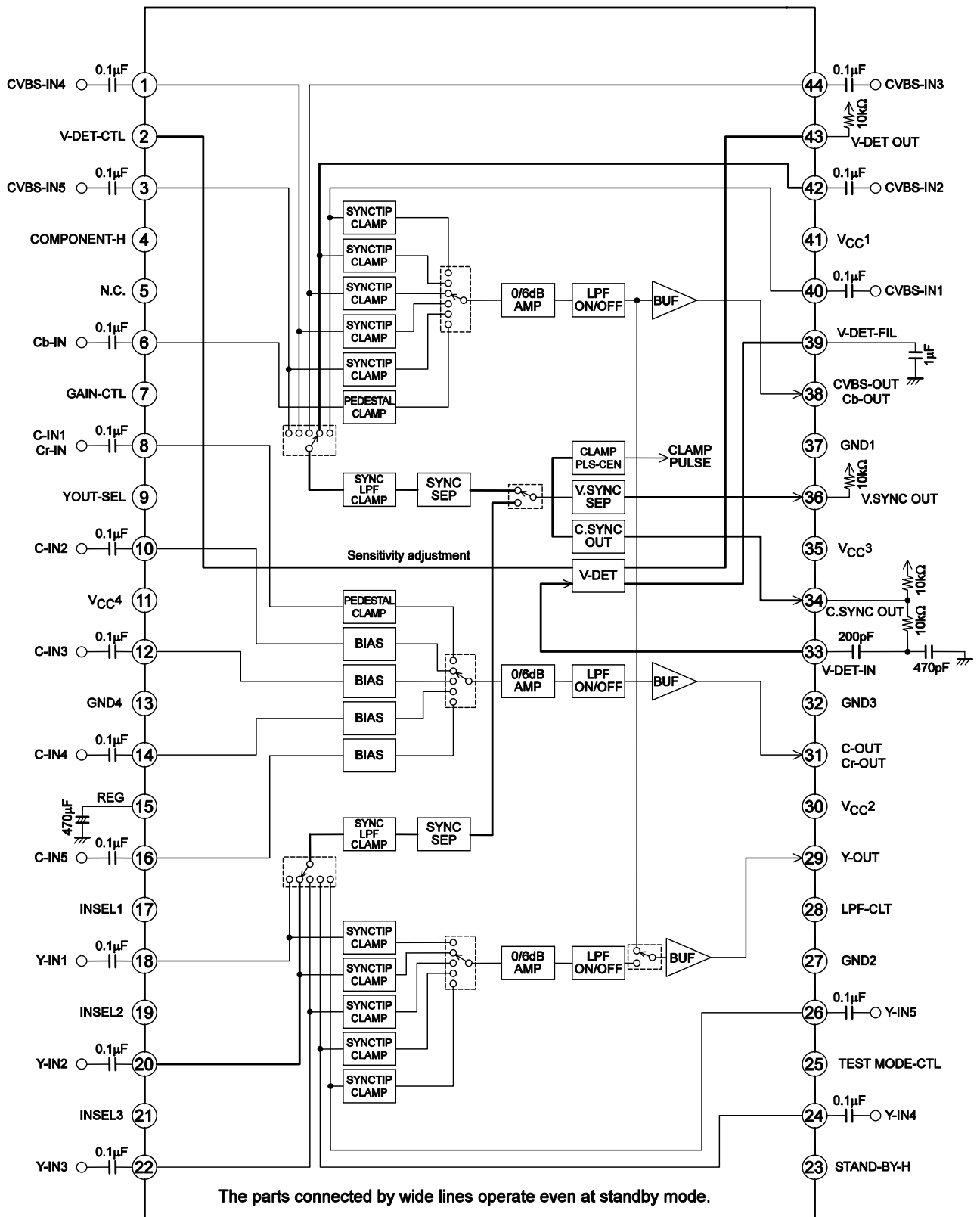

*2: Since Pin25 is test mode control, please apply GND level.

Block Diagram and Application Circuit Example

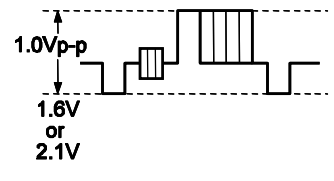
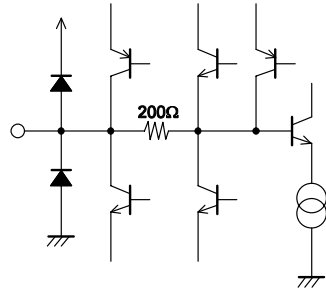
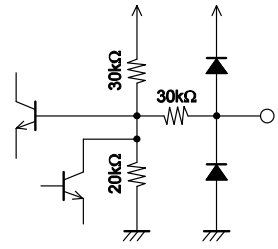
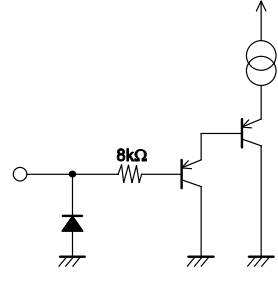

LA73031V

Pin Functions

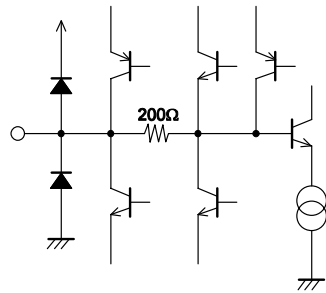
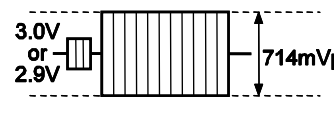
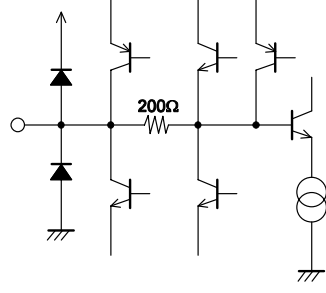
Pin No.	Pin name	Signal wave form	DC voltage AC level	Equivalent circuit
1 3 40 42 44	CVBS-IN4 CVBS-IN5 CVBS-IN1 CVBS-IN2 CVBS-IN3	 <p>1.0Vp-p 1.6V or 2.1V</p>	0dB: 1.6V 6dB: 2.1V	
		DC	No signal: 1.6V	
2	V-DET-CTL	DC	1.7 to 2.0V	
4	COMPONENT-H	DC	Except component mode: 0V Component mode: 5V	
7	GAIN-CTL	DC	0dB: 0V 6dB: 5V	
9	Y-OUT-SEL	DC	Y output: 0V CVBS output :5V	
17 19 21	INSEL1 INSEL2 INSEL3	DC	Low: 0V High: 5V	
23	STAND-BY-H	DC	Normal mode: 0V Standby mode: 5V	
28	LPF-CTL	DC	LPF-ON: 0V LPF-OFF: 5V	
6	Cb-IN	 <p>3.0V or 2.9V 700mVp-p</p>	0dB: 3.0V 6dB: 2.9V	
		DC	No signal: 1.6V	
8	C-IN1/ Cr-IN	 <p>3.0V or 2.9V 714mVp-p</p>	0dB: 3.0V 6dB: 2.9V	
		DC	No signal: 1.6V	

Continued on next page.

LA73031V

Continued from preceding page.

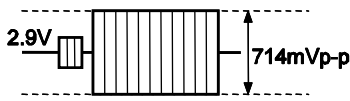
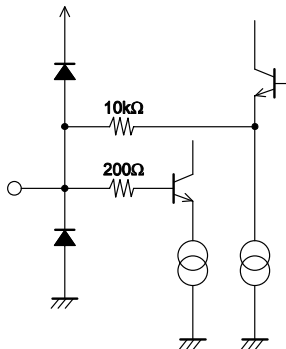
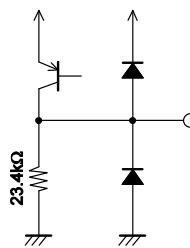
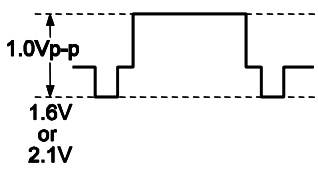
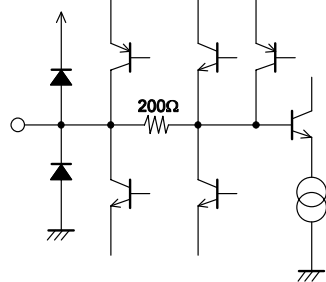
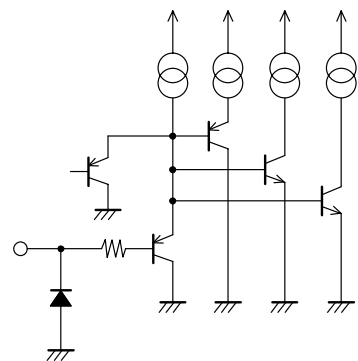
Pin No.	Pin name	Signal wave form	DC voltage AC level	Equivalent circuit
10 12 14 16	C-IN2 C-IN3 C-IN4 C-IN5	 <p style="text-align: center;">2.9V 714mVp-p</p>	2.9V	
		DC	No signal: 2.9V	
11 30 35 41	V _{CC} 4 V _{CC} 2 V _{CC} 3 V _{CC} 1			
13 27 32 37	GND4 GND2 GND3 GND1			
15	REG	DC	2.5V	
18 20 22 24 26	Y-IN1 Y-IN2 Y-IN3 Y-IN4 Y-IN5	 <p style="text-align: center;">1.0Vp-p 1.6V or 2.1V</p>	0dB: 1.6V 6dB: 2.1V	
		DC	No signal: 1.6V	
25	TEST MODE-CTL		GND	

Continued on next page.

LA73031V

Continued from preceding page.

Pin No.	Pin name	Signal wave form	DC voltage AC level	Equivalent circuit
29	Y-OUT		0.8V	
31	C-OUT/ Cr-OUT		2.3V	
38	CVBS-OUT/ Cb-OUT		CVBS output: 0.8V Component output: 2.3V	
33	V-DET-IN			
34 36	C.SYNC OUT V.SYNC OUT			
43	V-DET OUT	DC	No signal: 0.3V Input signal: 5V	
39	V-DET-FIL	DC		

Test Circuit

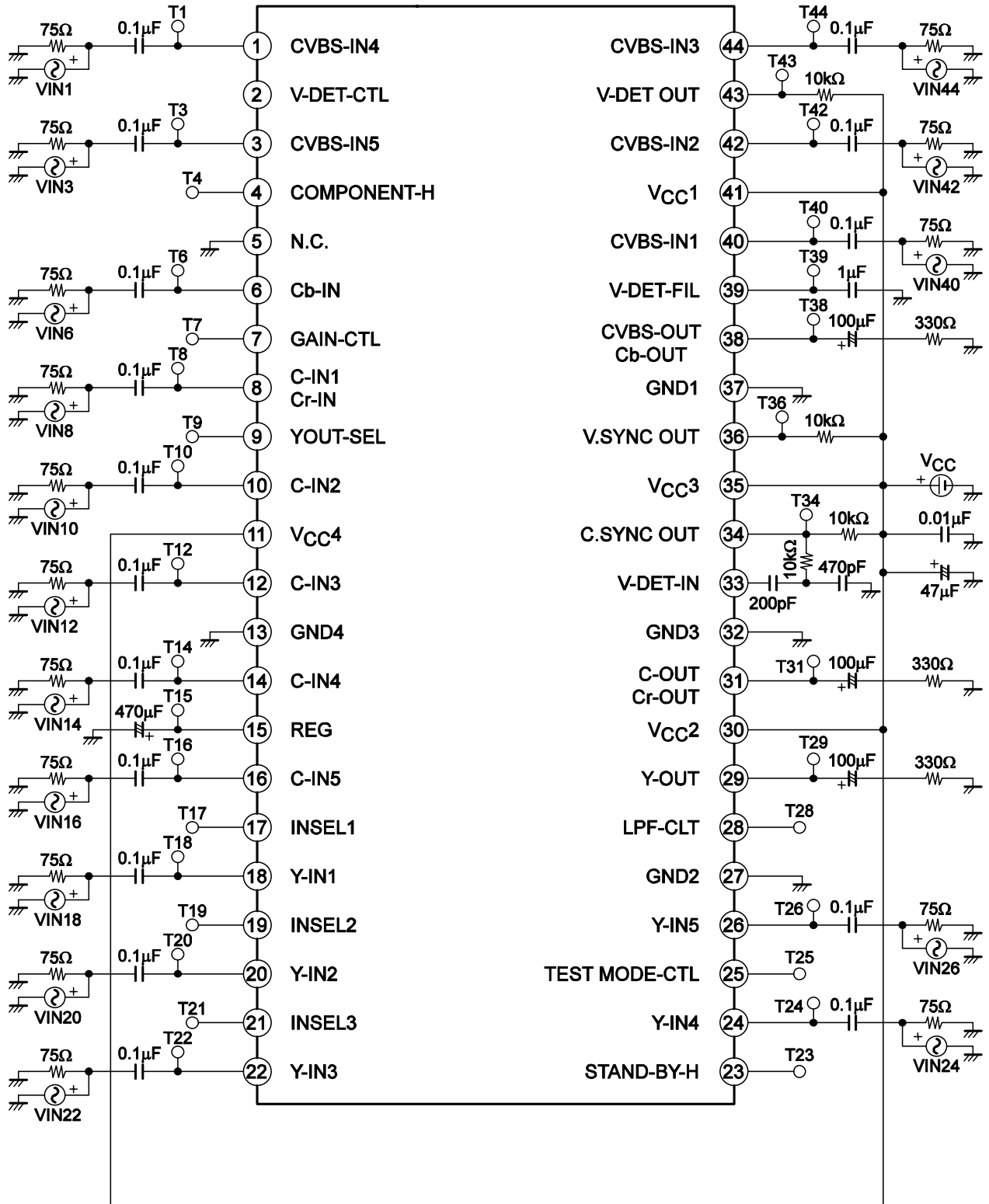

Input Signal

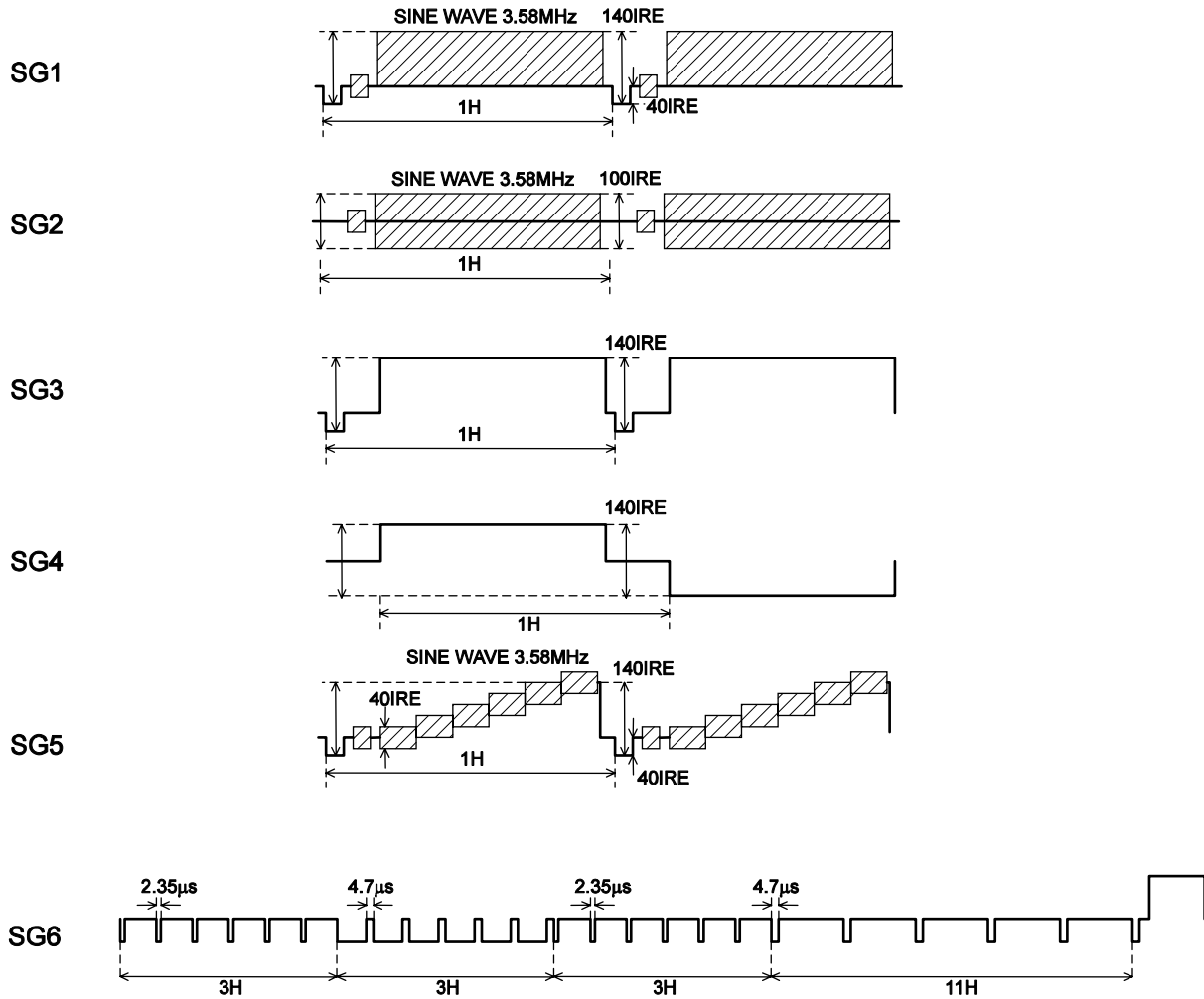

- Specifications of any and all SANYO Semiconductor products described or contained herein stipulate the performance, characteristics, and functions of the described products in the independent state, and are not guarantees of the performance, characteristics, and functions of the described products as mounted in the customer's products or equipment. To verify symptoms and states that cannot be evaluated in an independent device, the customer should always evaluate and test devices mounted in the customer's products or equipment.
- SANYO Semiconductor Co., Ltd. strives to supply high-quality high-reliability products. However, any and all semiconductor products fail with some probability. It is possible that these probabilistic failures could give rise to accidents or events that could endanger human lives, that could give rise to smoke or fire, or that could cause damage to other property. When designing equipment, adopt safety measures so that these kinds of accidents or events cannot occur. Such measures include but are not limited to protective circuits and error prevention circuits for safe design, redundant design, and structural design.
- In the event that any or all SANYO Semiconductor products (including technical data, services) described or contained herein are controlled under any of applicable local export control laws and regulations, such products must not be exported without obtaining the export license from the authorities concerned in accordance with the above law.
- No part of this publication may be reproduced or transmitted in any form or by any means, electronic or mechanical, including photocopying and recording, or any information storage or retrieval system, or otherwise, without the prior written permission of SANYO Semiconductor Co., Ltd.
- Any and all information described or contained herein are subject to change without notice due to product/technology improvement, etc. When designing equipment, refer to the "Delivery Specification" for the SANYO Semiconductor product that you intend to use.
- Information (including circuit diagrams and circuit parameters) herein is for example only; it is not guaranteed for volume production. SANYO Semiconductor believes information herein is accurate and reliable, but no guarantees are made or implied regarding its use or any infringements of intellectual property rights or other rights of third parties.

This catalog provides information as of June, 2006. Specifications and information herein are subject to change without notice.