

SANYO

No.2865

LA7535

Monolithic Linear IC

(VIF+SIF) Circuit for B/W TV Applications

The LA7535 is an IC that contains the VIF section and SIF section on a single chip and has the RF AGC of forward type most suitable for B/W TV use. The LA7535 can be used in conjunction with the LA7806 or LA7808 to provide the B/W TV function. The LA7535 is provided with two pins for IF AGC, permitting higher AGC speed. Since the LA7535 has the AFT function, it may be also applied for use in low-cost CTV applications.

If you want to use a version with the RF AGC of reverse type, the LA7530N is available.

Functions

- VIF section: VIF amp, video detector, peak IF AGC, B/W noise canceler, RF AGC, AFT, video mute
- SIF section: SIF limiter amp, FM detector, SND mute

Features

- The RF AGC is of forward type most suitable for B/W TV use.
- High-gain VIF amp requiring no preamp
- Two pins for IF AGC permitting higher AGC speed
- The FM detector uses the quadrature detection method. The use of a ceramic discriminator eliminates the need for audio adjust process.
- Since the LA7535 has the AFT function, it may be also applied for use in low-cost CTV applications.
- Small-sized package and minimum number of external parts required. Capable of being operated from 9V supply.

Equivalent Circuit Block Diagram

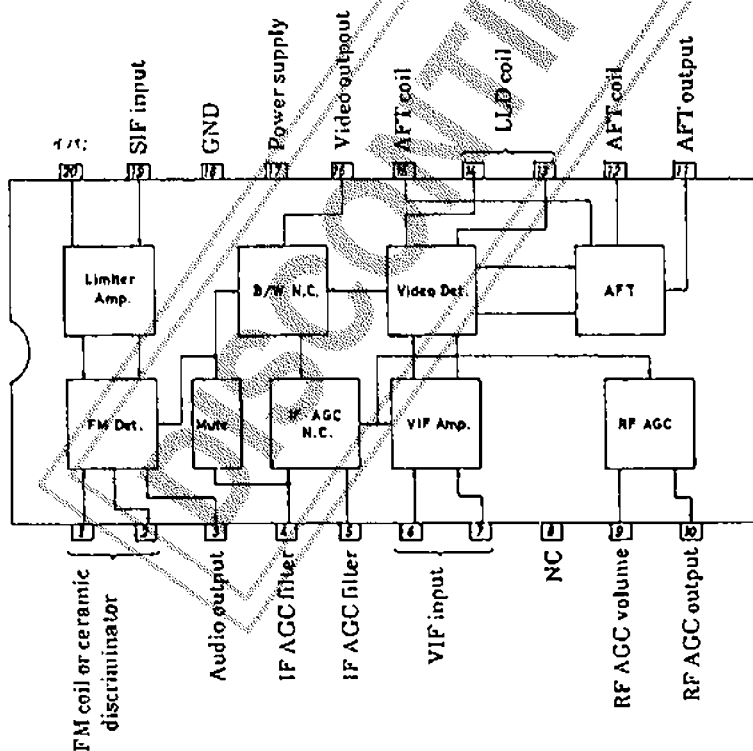

Case Outline 3021B-D20SIC
(unit:mm)

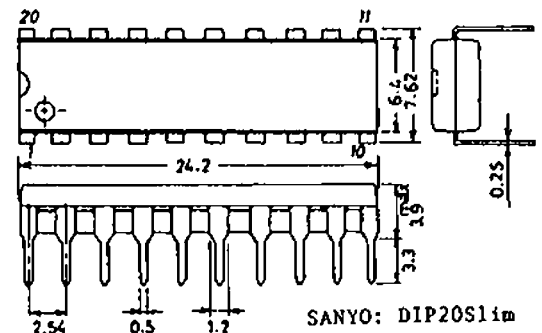

Specifications and information herein are subject to change without notice.

SANYO Electric Co., Ltd. Semiconductor Overseas Marketing Div.
Natsume Bldg., 18-6, 2-chome, Yushima, Bunkyo-ku, TOKYO 113 JAPAN

LA7535

Maximum Ratings at Ta = 25°C, V _{CC} = 12V				unit
Maximum Supply Voltage	V _{CC} max		14	V
Flow-out Current	I ₁₆ max		5	mA
Allowable Power Dissipation	P _d max	Ta ≤ 40°C	1.1	W
Operating Temperature	T _{opg}		-20 to +70	°C
Storage Temperature	T _{stg}		-55 to +125	°C

Operating Conditions at Ta = 25°C				unit
Recommended Supply Voltage	V _{CC}		12	V
Operating Voltage Range	V _{CC op}		9 to 13.2	V

Operating Characteristics at Ta = 25°C, V _{CC} = 12V				min	typ	max	unit
Circuit Current	I ₁₇	DC	47	58	74	mA	
Maximum RF AGC Voltage	V _{10H}	DC	10.2	10.6	11.0	V	
Minimum RF AGC Voltage	V _{10L}	DC		0	0.5	V	
Quiescent Video Output Voltage	V ₁₆	DC	5.7	6.1	6.5	V	
Input Sensitivity	V _i	f _m = 400Hz, 40%AM, V _o = 0.8V _{p-p}	30	36	42	dBu	
AGC Range	GR	f _m = 400Hz, 40%AM, V _o = 0.8V _{p-p}	57	64		dB	
Maximum Allowable Input Video Output Amplitude	V _i max	f _m = 15kHz, 78%AM, V _o = 10mV _{rms}	100	200		mV _{rms}	
Output S/N	S/N	10mV CW	48	54		dB	
SIF Output Signal Voltage	V _o (SIF)	P/S = 20dB	80	140	210	mV _{rms}	
Frequency Characteristic	f _c	-3dB	5	7		MHz	
Input Resistance	r _i			1.5		kΩ	
Input Capacitance	c _i			3.0		pF	
SIF Limiting Voltage	V _i (Lim)	-3dB		200	500	μV _{rms}	
Detection Output Voltage	V _o (Det)	V _i = 100mV _{rms} , f _m = 400Hz, Δf = ±25kHz	450	680	850	mV _{rms}	
Total Harmonic Distortion	THD(Def)	V _i = 100mV _{rms} , f _m = 400Hz, Δf = ±25kHz		0.5	1.3	%	
AM Rejection	AMR	30%AM	50	60		dB	

RF AGC Output Circuit Configuration

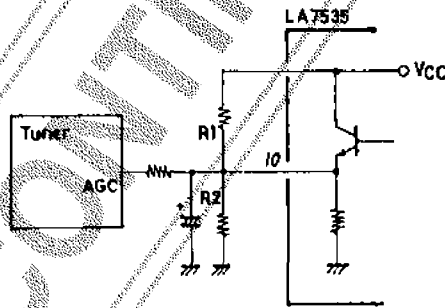

Fig. 1

The RF AGC output circuit is configured as shown Fig. 1. In general, the gain reduction characteristic of a tuner of forward type is as shown in Fig. 2. Control is exercised at more than V₁. Obtain the ratio of R₁, R₂ referring to the specification for the tuner and fix V₁.

$$V_1 = \frac{R_2}{R_1 + R_2} \times V_{CC}$$

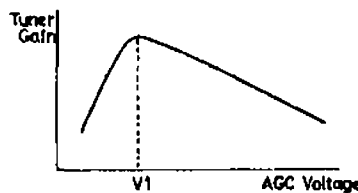
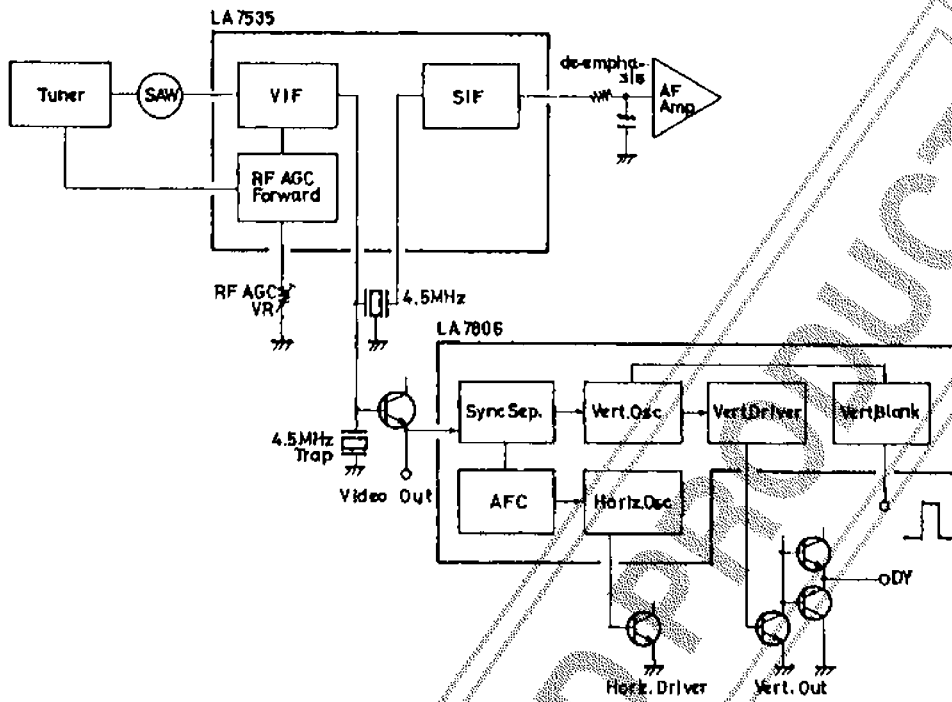

Fig. 2

LA7535

Sample Application Circuits

1. LA7535 + LA7806 + TR



2. LA7535 + LA7808 + LA1385

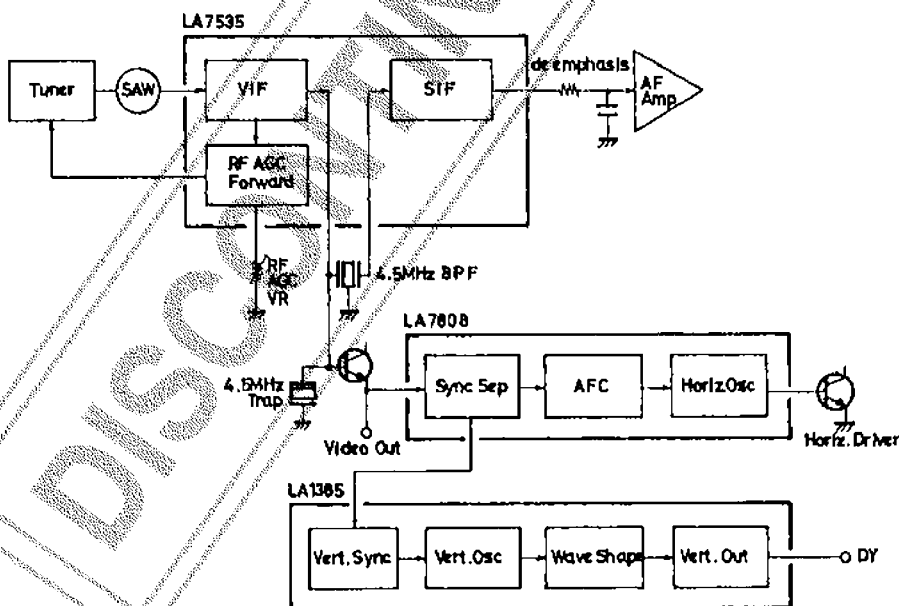

LA7535

3. B/W TV use

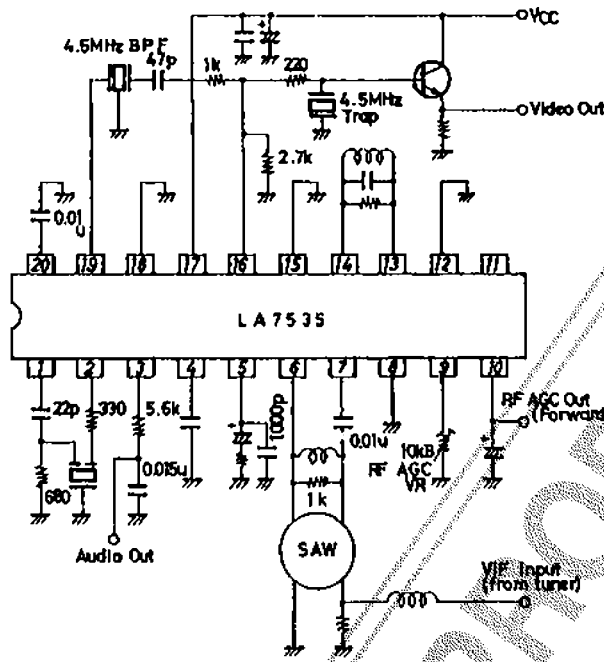

When the AFT circuit is not used, connect pins 12, 15 to GND.

4. Low-cost CTV use

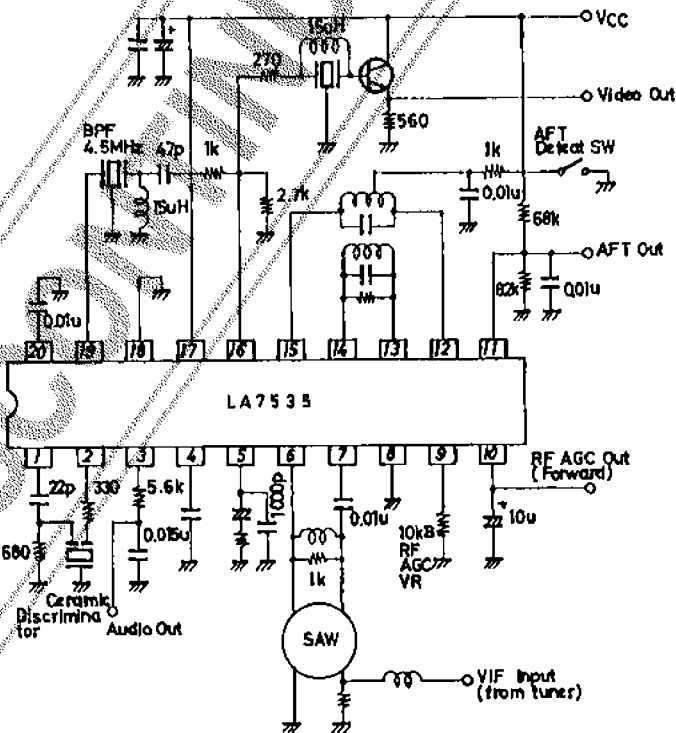

The application circuit diagrams and circuit constants herein are included as an example and provide no guarantee for designing equipment to be mass-produced. The information herein is believed to be accurate and reliable. However, no responsibility is assumed by SANYO for its use; nor for any infringements of patents or other rights of third parties which may result from its use.