

**LA7800****Color TV Synchronization, Deflection Circuit****Overview**

The LA7800 is a multifunctional IC containing various functions required for synchronization, deflection of color television sets. This IC has been developed under the design concept that the basic characteristics should be made more complete and the television sets with this IC incorporated should be streamlined by making the device compact (DIP-16) and by minimizing the number of parts required.

Functions

- Synchronizing separation.
- Horizontal AFC.
- Horizontal oscillation.
- Vertical oscillation.
- Vertical drive.
- X-ray protection.
- Vertical blanking.

Features

- Multifunction and compact (DIP-16).
- Minimum number of parts required.
- Horizontal and vertical oscillators are stable against variations in ambient temperature and supply voltage due to small warm-up drift.
- Small variation in horizontal oscillation frequency.
- Good linearity and interlace because DC bias at vertical output stage is subjected to sampling control within retrace time.
- Vertical blanking pulse width can be set freely according to peripheral parts.

Package Dimensions

unit:mm

3006B-DIP16

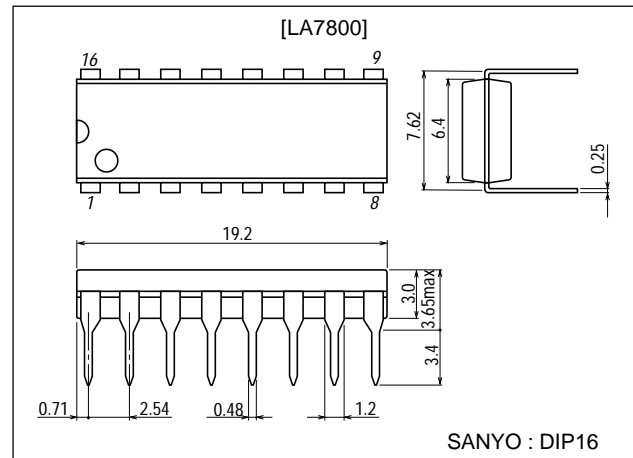
**Specifications****Maximum Ratings** at $T_a = 25^\circ\text{C}$

Parameter	Symbol	Conditions	Ratings	Unit
Maximum supply voltage	V_{12}		14	V
Maximum supply current	I_{15}		16	mA
Allowable power dissipation	$P_d \text{ max}$	$T_a \leq 60^\circ\text{C}$	450	mW
Operating temperature	T_{opr}		-20 to +85	$^\circ\text{C}$
Storage temperature	T_{stg}		-55 to +125	$^\circ\text{C}$

■ Any and all SANYO products described or contained herein do not have specifications that can handle applications that require extremely high levels of reliability, such as life-support systems, aircraft's control systems, or other applications whose failure can be reasonably expected to result in serious physical and/or material damage. Consult with your SANYO representative nearest you before using any SANYO products described or contained herein in such applications.

■ SANYO assumes no responsibility for equipment failures that result from using products at values that exceed, even momentarily, rated values (such as maximum ratings, operating condition ranges, or other parameters) listed in products specifications of any and all SANYO products described or contained herein.

SANYO Electric Co., Ltd. Semiconductor Company

TOKYO OFFICE Tokyo Bldg., 1-10, 1 Chome, Ueno, Taito-ku, TOKYO, 110-8534 JAPAN

LA7800

Recommended Operating Conditions at $T_a = 25^\circ\text{C}$

Parameter	Symbol	Conditions	Ratings	Unit
Recommended supply voltage	V_{12}		12	V

Operating Characteristics at $T_a = 25^\circ\text{C}$, $V_{12}=12\text{V}$, $I_{CC15}=13\text{mA}$

Parameter	Symbol	Conditions	Ratings			Unit
			min	typ	max	
V_{CC12} current drain	I_{CC12}		13.0		20.0	mA
V_{CC15} supply voltage	V_{CC15}		11.8		13.2	V
Vertical frequency pull-in range			9.0		11.0	Hz
Vertical free-running frequency	f_V	f_V center 55Hz	50		60	Hz
Supply voltage dependence of vertical frequency		$V_{12}=12\pm 1\text{V}$, 55Hz at 12V	-0.5		+0.5	Hz
Temperature characteristics of vertical frequency		$T_a=-10$ to $+60^\circ\text{C}$	-0.028		+0.028	Hz/ $^\circ\text{C}$
Vertical driver amplification factor			4.0		7.0	$^\circ\text{C}$
Horizontal free-running frequency	f_H	f_H center 15.734kHz	-750		+750	Hz
Supply voltage dependence of horizontal frequency		$V_Z-V_Z \times 90\%$	-50		+50	Hz
Temperature characteristic of horizontal frequency		$T_a=-10$ to $+60^\circ\text{C}$	-3.4		+3.4	Hz/ $^\circ\text{C}$
Horizontal output pulse width		$f_H=15.734\text{kHz}$	21.5		26.5	μs
Horizontal output drive current			3.8		7.2	mA

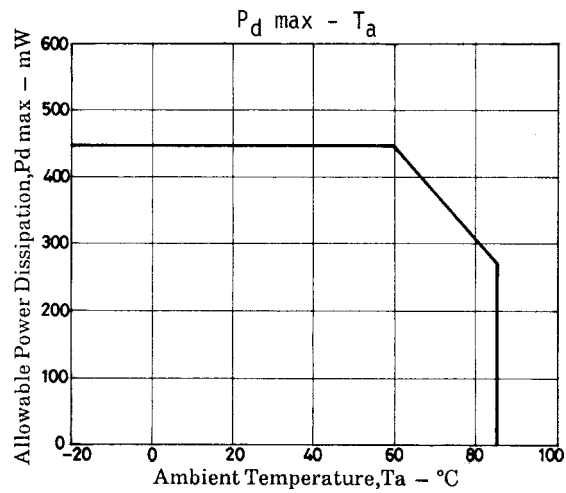

LA7800

Sample Application Circuit

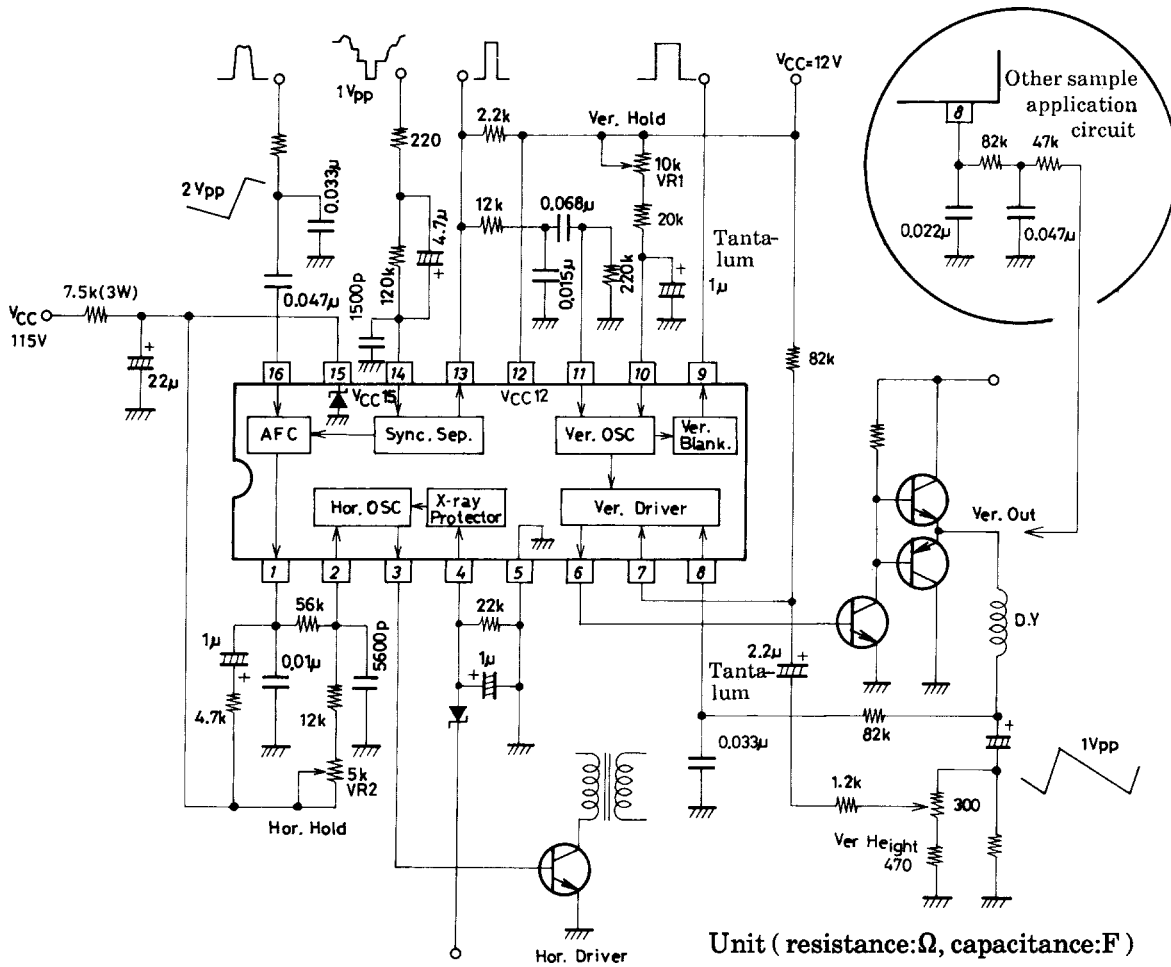

- Note)
1. The vertical output circuit is represented by the basic circuit.
 2. The peripheral parts connected to pin 8 are changed according to the Ver. Out circuit conditions.
 3. The limit resistor (220Ω : 1Vp-p) connected to pin 14 is changed according to the magnitude of the input video signal.
 4. The time constant circuit (120kΩ, 4.7μF) connected to pin 14 is such that the resistor is changed according to the DC level of the input video signal and the time constant is changed with the capacitance value.

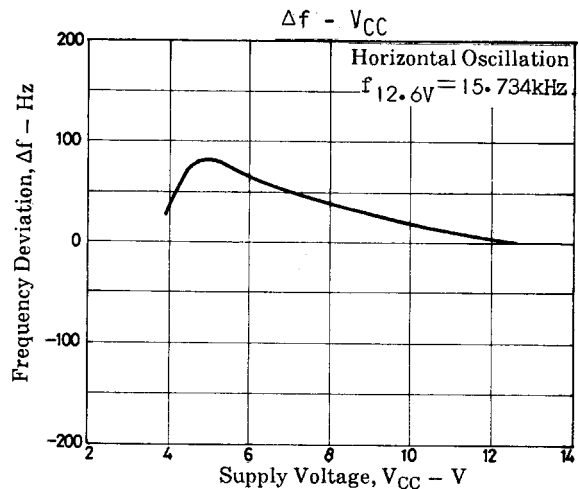
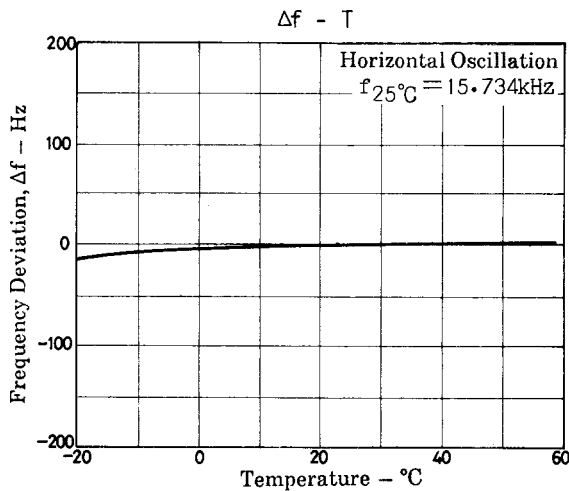

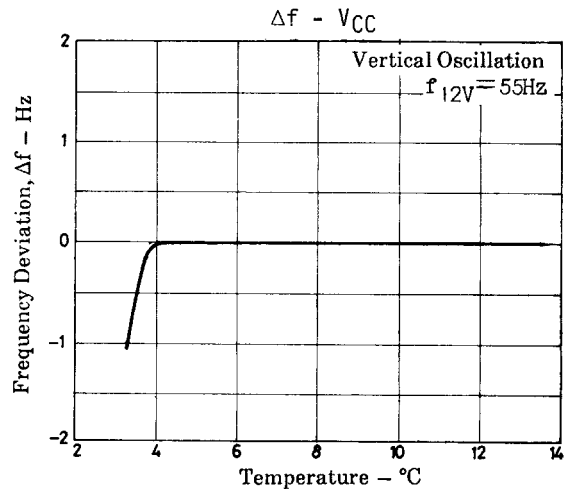
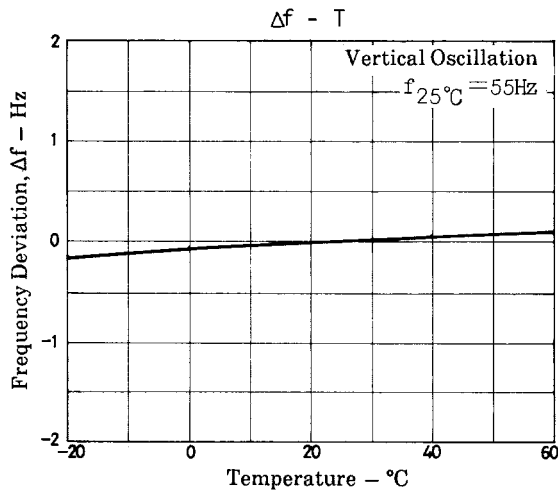

Note) The temperature characteristic of oscillation frequency represents the one for IC itself without peripheral parts.

- Specifications of any and all SANYO products described or contained herein stipulate the performance, characteristics, and functions of the described products in the independent state, and are not guarantees of the performance, characteristics, and functions of the described products as mounted in the customer's products or equipment. To verify symptoms and states that cannot be evaluated in an independent device, the customer should always evaluate and test devices mounted in the customer's products or equipment.
- SANYO Electric Co., Ltd. strives to supply high-quality high-reliability products. However, any and all semiconductor products fail with some probability. It is possible that these probabilistic failures could give rise to accidents or events that could endanger human lives, that could give rise to smoke or fire, or that could cause damage to other property. When designing equipment, adopt safety measures so that these kinds of accidents or events cannot occur. Such measures include but are not limited to protective circuits and error prevention circuits for safe design, redundant design, and structural design.
- In the event that any or all SANYO products (including technical data, services) described or contained herein are controlled under any of applicable local export control laws and regulations, such products must not be exported without obtaining the export license from the authorities concerned in accordance with the above law.
- No part of this publication may be reproduced or transmitted in any form or by any means, electronic or mechanical, including photocopying and recording, or any information storage or retrieval system, or otherwise, without the prior written permission of SANYO Electric Co., Ltd.
- Any and all information described or contained herein are subject to change without notice due to product/technology improvement, etc. When designing equipment, refer to the "Delivery Specification" for the SANYO product that you intend to use.
- Information (including circuit diagrams and circuit parameters) herein is for example only; it is not guaranteed for volume production. SANYO believes information herein is accurate and reliable, but no guarantees are made or implied regarding its use or any infringements of intellectual property rights or other rights of third parties.

This catalog provides information as of January, 2001. Specifications and information herein are subject to change without notice.