



LA7953

Audio Controller for TV Use

Overview

The LA7953 Audio Controller is a single-chip, liner IC featuring a built-in expansion circuit. The device also features a 4-input 1-output audio switch, an acoustic mute, a LINE-OUT output, and audio control functions for volume, balance, bass and treble on-chip.

Excellent audio reproduction can be obtained using the right channel expansion circuit.

The LA7953 operates on a single 12V power supply and is available in 30-pin plastic DIPs.

Features

- On-chip audio controller and audio switch facilitate design.
- Audio controller for volume, balance, bass and treble.
- 4-input/1-output audio switch.
- On-chip expansion circuit ensures excellent sound reproduction.
- LINE-OUT output.
- Acoustic mute.

Package Dimensions

unit:mm

3061-DIP30S

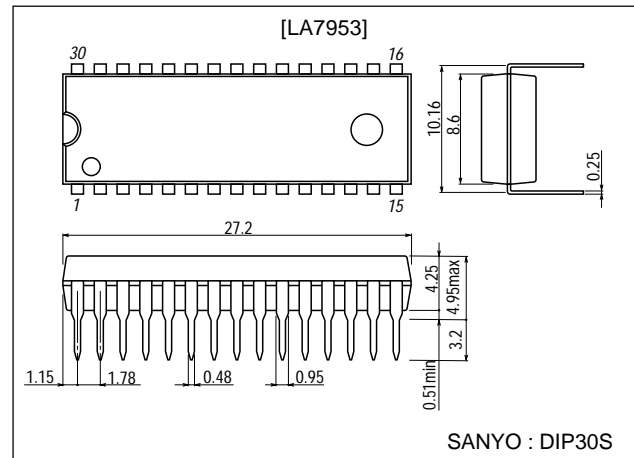

Specifications

Maximum Ratings at Ta = 25°C

Parameter	Symbol	Conditions	Ratings	Unit
Maximum supply voltage	V _{CC} max		14	V
Input applied voltage 1	V _{1, 3, 5, 7, 9, 11, 13, 15} max	V _{CC} =14V	12	V
Input applied voltage 2	V _{2, 14, 16, 30} max	V _{CC} =14V	14	V
Input applied voltage 3	V ₄ max, V ₆ max	V _{CC} =14V	14	V
Mute input applied voltage	V ₈ max	V _{CC} =14V	14	V
Expansion input applied voltage	V ₁₂ max	V _{CC} =14V	14	V
LINE-OUT output current	I _{17, 29} max		5	mA
Maximum output current	I _{23, 25} max		5	mA
Expansion output current	I ₁₉ max		5	mA
Tone control input applied voltage	V ₂₀ max, V ₂₈ max	V _{CC} =14V	14	V
Bass filter applied voltage	V ₂₂ max, V ₂₆ max	V _{CC} =14V	14	V
Treble filter applied voltage	V ₂₁ max, V ₂₇ max	V _{CC} =14V	14	V

Continued on next page.

■ Any and all SANYO products described or contained herein do not have specifications that can handle applications that require extremely high levels of reliability, such as life-support systems, aircraft's control systems, or other applications whose failure can be reasonably expected to result in serious physical and/or material damage. Consult with your SANYO representative nearest you before using any SANYO products described or contained herein in such applications.

■ SANYO assumes no responsibility for equipment failures that result from using products at values that exceed, even momentarily, rated values (such as maximum ratings, operating condition ranges, or other parameters) listed in products specifications of any and all SANYO products described or contained herein.

SANYO Electric Co., Ltd. Semiconductor Company

TOKYO OFFICE Tokyo Bldg., 1-10, 1 Chome, Ueno, Taito-ku, TOKYO, 110-8534 JAPAN

LA7953

Continued from preceding page.

Parameter	Symbol	Conditions	Ratings	Unit
Expansion filter applied voltage	V_{18} max	$V_{CC}=14V$	12	V
Allowable power dissipation	P_d max	$T_a \leq 65^\circ C$	1100	mW
Operating temperature	T_{opr}		-20 to +65	$^\circ C$
Storage temperature	T_{stg}		-55 to +150	$^\circ C$

Operating Conditions at $T_a = 25^\circ C$

Parameter	Symbol	Conditions	Ratings	Unit
Recommended supply voltage	V_{CC}		12	V
Operating voltage range	V_{CC} op		10.5 to 13.2	V

Operating Characteristics at $T_a = 25^\circ C$, $V_{CC}=12V$

Parameter	Symbol	Conditions	Test Circuit	Ratings			Unit
				min	typ	max	
[Audio SW]							
Input bias voltage	$V_{1, 3, 5, 7, 9, 11, 13, 15}$		1	4.4	5.3	6.2	V
LINE-OUT output bias voltage	$V_{17, 29}$	S4, S5=H	1	2.1	3.0	3.9	V
LINE-OUT output DC offset voltage	V_{OS}	Differential voltage when LINE-OUT output is switched.	1	-100	0	+100	mV
Control threshold voltage	V_{4H}, V_{6H}		2	3.0			V
Control threshold voltage	V_{4L}, V_{6L}		2			1.5	V
LINE-OUT voltage gain	G_{LV}	$V_{IN}=500mV_{rms}$, $f=1kHz$	2	-1	0	+1	dB
LINE-OUT distortion ratio	THD_L	$V_{IN}=500mV_{rms}$, $f=100Hz, 1kHz$, L.P.F=80kHz	2		0.05	0.2	%
LINE-OUT noise	V_{NL}	$R_g=600\Omega$, 15kHz band	2		10	30	μV_{rms}
Mute input threshold voltage	V_{8TH}		2	3.0			V
Mute input threshold voltage	V_{8TL}					1.5	V
Input impedance	$Z_{1, 3, 5, 7, 9, 11, 13, 15}$		1	47	68	89	k Ω
LINE-OUT output impedance	$Z_{17, 29}$		1		50	150	Ω
[Audio Control]							
Quiescent current drain (including audio switch)	I_{CC}		1	35	45	65	mA
Output bias voltage	V_{23}, V_{25}	$V_{30}=12V$, $V_2=V_{14}=V_{16}=6V$	1	4	5.5	7	V
Left & right channel output DC offset	V_{23} to 25	$V_{30}=12V$, $V_2=V_{14}=V_{16}=6V$	1	-2	+0.2	+2	V
Output voltage	V_O	$V_{IN}=500mV_{rms}$, $f=1kHz$, $V_{30}=12V$, $V_2=V_{14}=V_{16}=6V$	2	390	450	630	mV $_{rms}$
Channel balance	C_{Ba}	$V_{IN}=500mV_{rms}$, $f=1kHz$, $V_{30}=12V$, $V_2=V_{14}=V_{16}=6V$	2	-1	+0.4	+1	dB
Dynamic range	THD_D	$V_{IN}=0.8mV_{rms}$, $f=40Hz, 15kHz$, L.P.F=80kHz, $V_{30}=12V$, $V_2=V_{14}=V_{16}=6V$	2		0.25	2	%
Left & right channel attenuation	ATT	$V_{OUT}=500mV_{rms}$ (0dB), $f=1kHz$, $V_{30}=0V$, $V_2=V_{14}=V_{16}=6V$	2	65	72		dB
Bass control, boost	GB_{BOOST}	$V_{OUT}=500mV_{rms}$ (1k), $f=40Hz$, $V_{30}=V_{14}=12V$, $V_2=V_{16}=6V$	2	7	9	12	dB
Bass control, cut	GB_{CUT}	$V_{OUT}=500mV_{rms}$ (1k), $f=40Hz$, $V_{30}=12V$, $V_{14}=0V$, $V_2=V_{16}=6V$	2	-1.3	-9	-6.5	dB
Treble control, boost	GB_{BOOST}	$V_{OUT}=500mV_{rms}$ (1k), $f=15kHz$, $V_{30}=V_{11}=12V$, $V_2=V_{14}=6V$	2	6.5	9	13	dB
Treble control, cut	GT_{CUT}	$V_{OUT}=500mV_{rms}$ (1k), $f=15kHz$, $V_{30}=12V$, $V_{14}=0V$, $V_2=V_{16}=6V$	2	-18	-9	-6.5	dB
Balance control	ATT_{BR}	$V_{OUT}=500mV_{rms}$ (0dB), $f=1kHz$, $V_{30}=12V$, $V_2=0V$, $V_{14}=V_{16}=6V$	2		-55	-40	dB
Balance control	ATT_{BL}	$V_{OUT}=500mV_{rms}$ (0dB), $f=1kHz$, $V_{30}=V_2=12V$, $V_{14}=V_{16}=6V$	2		-55	-40	dB
Crosstalk	CT	$V_{OUT}=500mV_{rms}$ (0dB), $f=1kHz$, $V_{30}=12V$, $V_2=V_{14}=V_{16}=6V$	2	65	80		dB
Noise	V_N	15kHz band, $V_{30}=12V$, $V_2=V_{14}=V_{16}=6V$	2		80	240	μV_{rms}
Total harmonic distortion	THD	$V_{IN}=500mV_{rms}$, $f=1kHz$, L.P.F=80kHz, $V_{30}=12V$, $V_2=V_{14}=V_{16}=6V$	2		0.2	0.5	%
Expansion characteristics	P_{EXP}	$V_{IN}=500mV_{rms}$, $f=1kHz$, $C=0.047\mu$, $V_{30}=12V$, $V_2=V_{14}=V_{16}=6V$	2	125	145	165	$^\circ C$
Expansion characteristics	G_{EXP}	$V_{IN}=500mV_{rms}$, $f=1kHz$, $C=0.047\mu$, $V_{30}=12V$, $V_2=V_{14}=V_{16}=6V$	2	-1	0	+1	dB
Expansion control threshold voltage	V_{EXPH}		2	3.0			V
Expansion control threshold voltage	V_{EXPL}		2			1.5	V
Left & right channel output impedance	Z_{LR}		1		150	300	Ω

LA7953

Audio Switch Truth Table

S4 (Pin 4)	S5 (Pin 6)	L1 (Pin 1)	L2 (Pin 3)	L3 (Pin 5)	L4 (Pin 7)	R1 (Pin 9)	R2 (Pin 11)	R3 (Pin 13)	R4 (Pin 15)
H	H	ON	OFF	OFF	OFF	ON	OFF	OFF	OFF
L	H	OFF	ON	OFF	OFF	OFF	ON	OFF	OFF
H	L	OFF	OFF	ON	OFF	OFF	OFF	ON	OFF
L	L	OFF	OFF	OFF	ON	OFF	OFF	OFF	ON

Equivalent Circuit Block Diagram

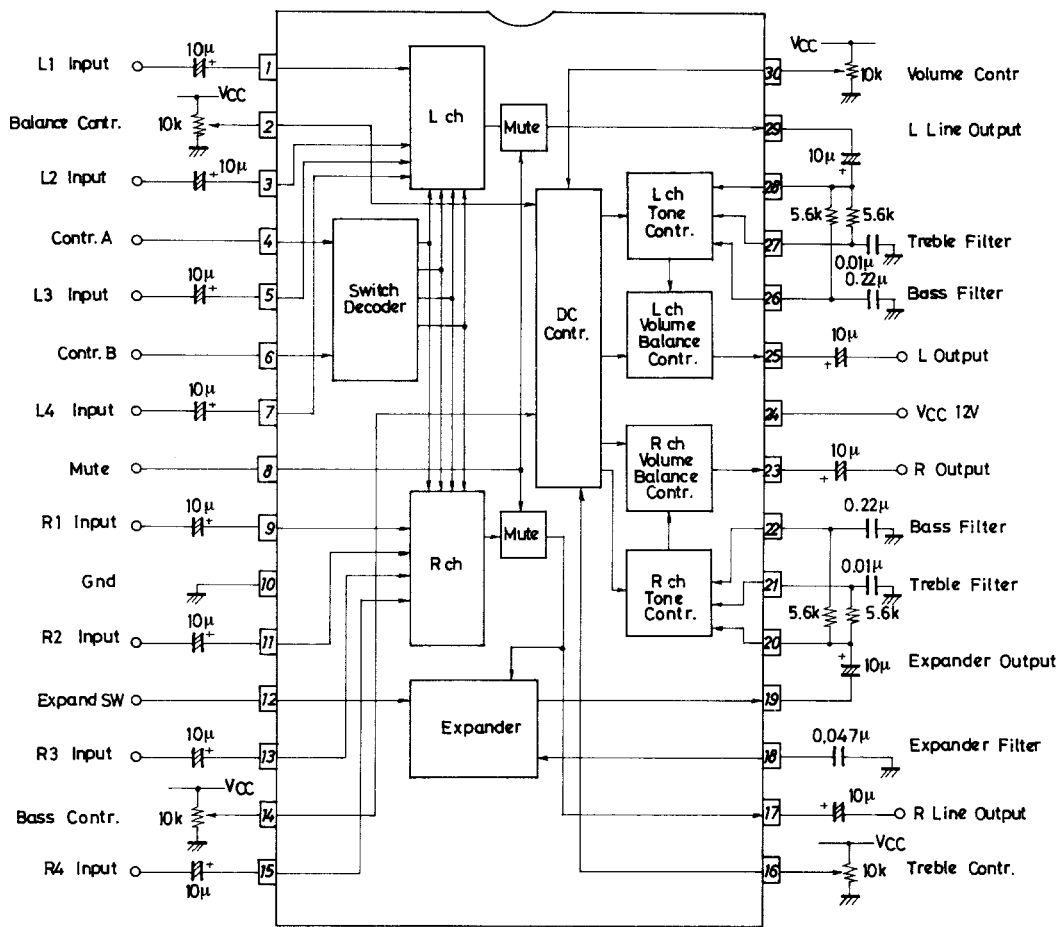

Unit (resistance : Ω , capacitance : F)

LA7953

I/O Equivalent Circuits

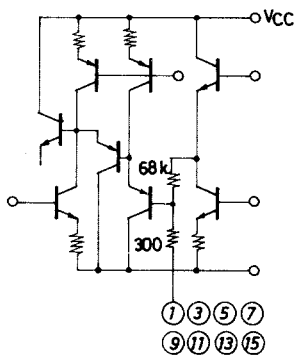

R, L Input

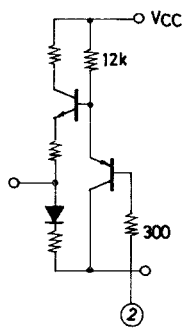

Balance Contr.

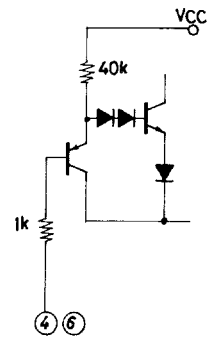

Contr. A, B

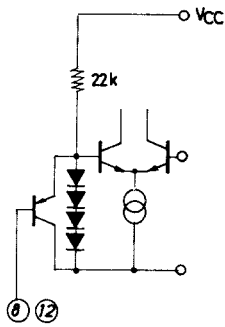

Mute, Expand SW

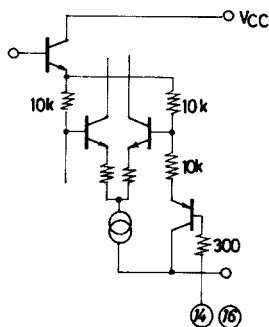

Bass, Treble Contr.

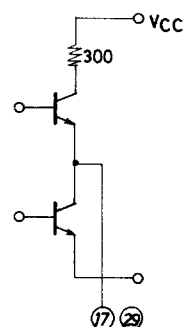

R, L Line Output

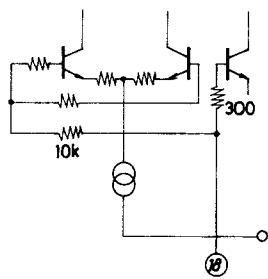

Expander Filter

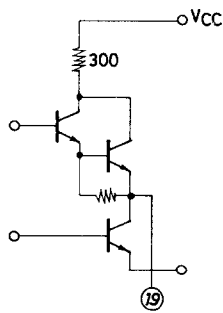

Expander Output

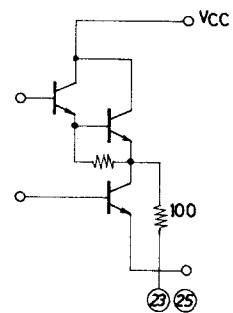

R, L Output

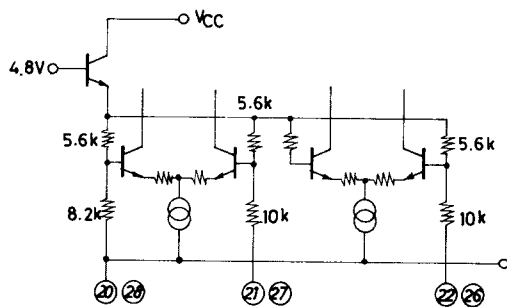

Treble, Bass Filter

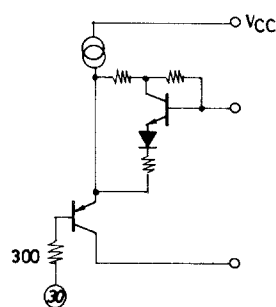

Volume Contr.

Unit (resistance : Ω)

LA7953

Test Circuit (1)

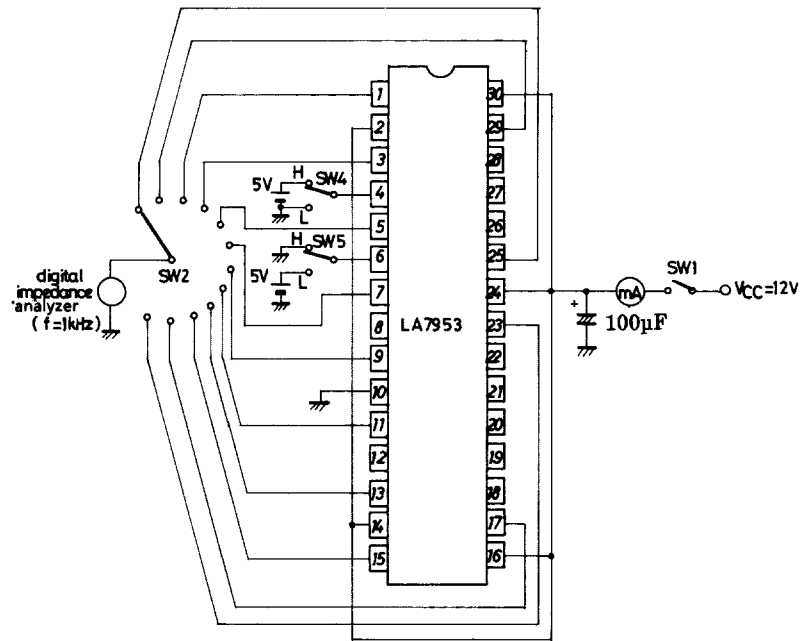

Test Circuit (2)

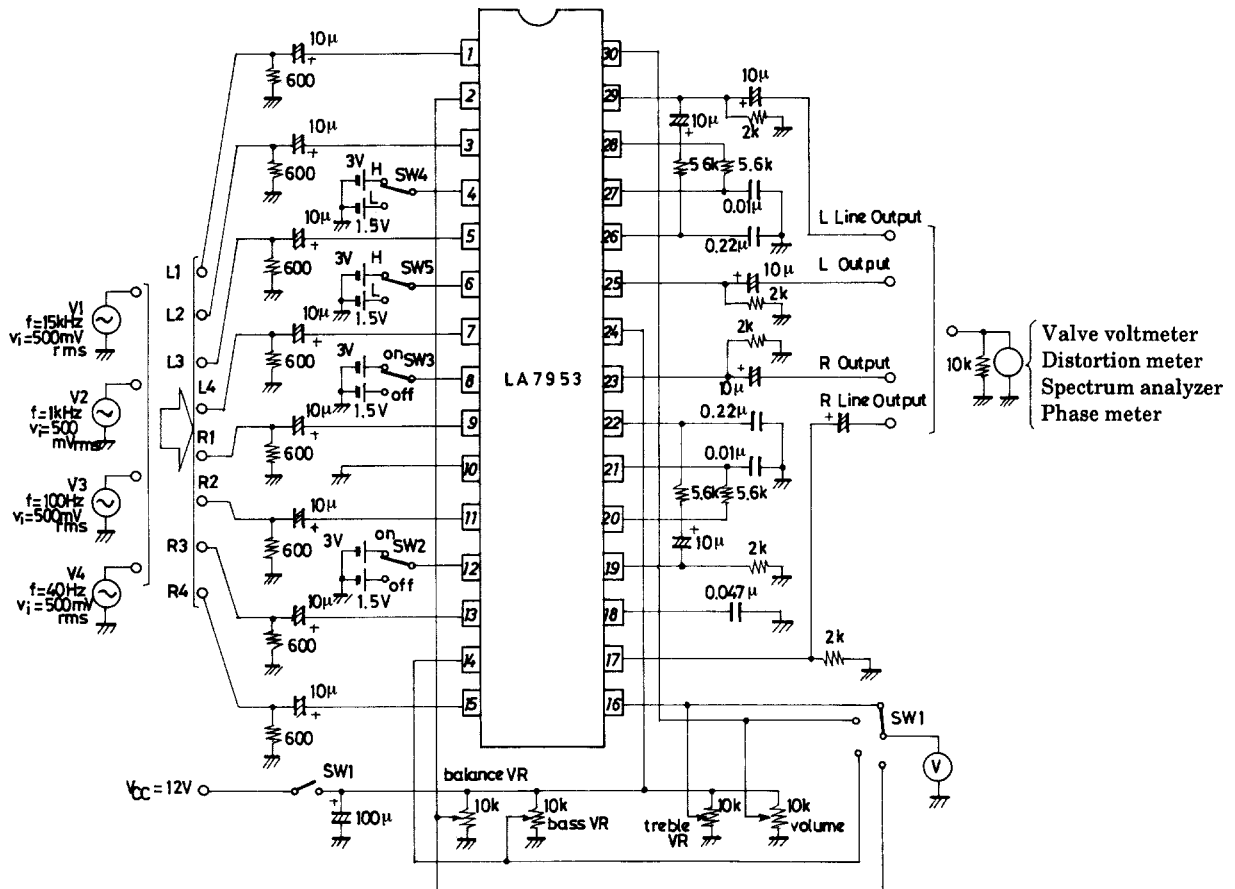

Unit (resistance : Ω , capacitance : F)

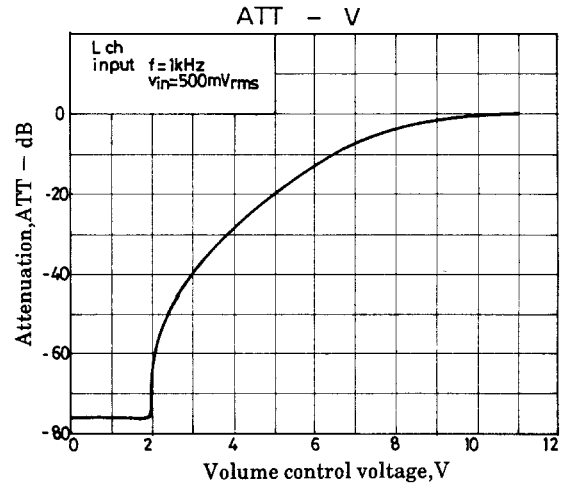
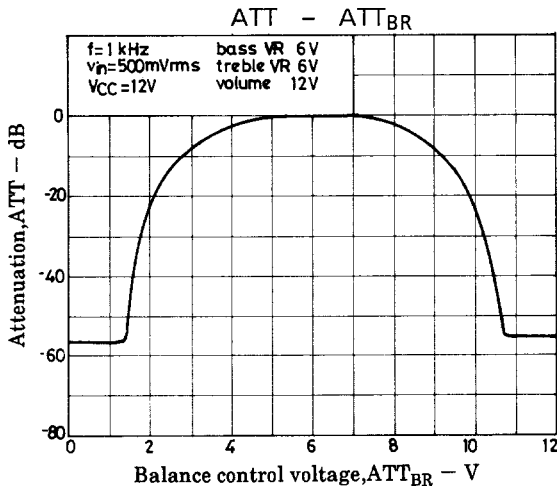
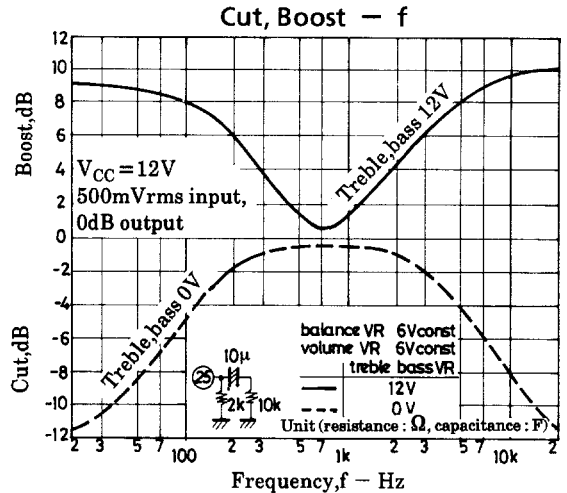
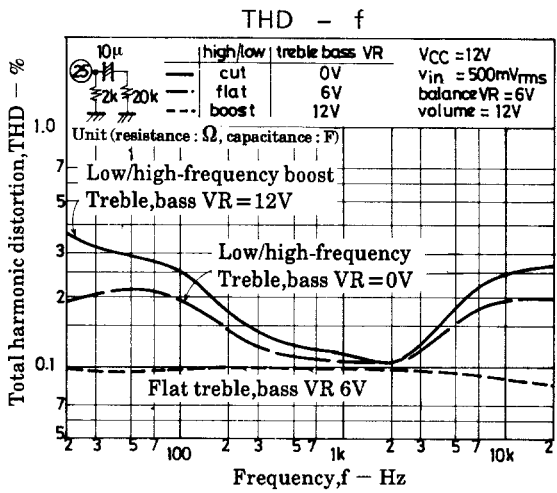
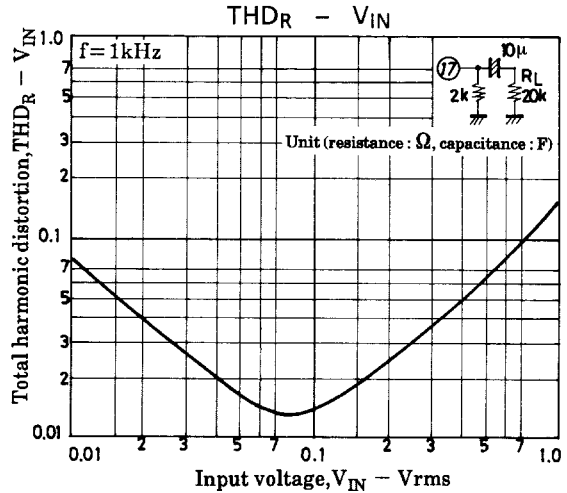
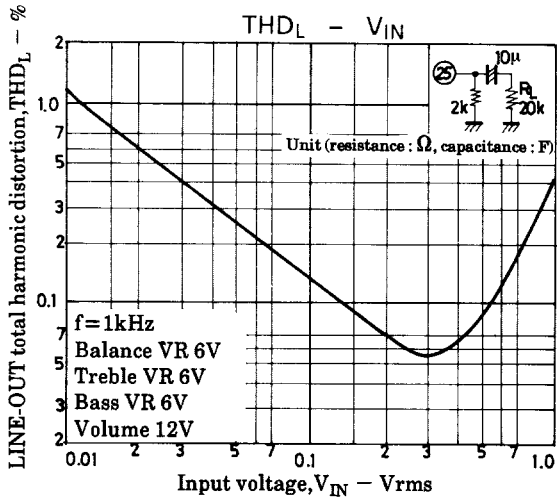

- Specifications of any and all SANYO products described or contained herein stipulate the performance, characteristics, and functions of the described products in the independent state, and are not guarantees of the performance, characteristics, and functions of the described products as mounted in the customer's products or equipment. To verify symptoms and states that cannot be evaluated in an independent device, the customer should always evaluate and test devices mounted in the customer's products or equipment.
- SANYO Electric Co., Ltd. strives to supply high-quality high-reliability products. However, any and all semiconductor products fail with some probability. It is possible that these probabilistic failures could give rise to accidents or events that could endanger human lives, that could give rise to smoke or fire, or that could cause damage to other property. When designing equipment, adopt safety measures so that these kinds of accidents or events cannot occur. Such measures include but are not limited to protective circuits and error prevention circuits for safe design, redundant design, and structural design.
- In the event that any or all SANYO products(including technical data, services) described or contained herein are controlled under any of applicable local export control laws and regulations, such products must not be exported without obtaining the export license from the authorities concerned in accordance with the above law.
- No part of this publication may be reproduced or transmitted in any form or by any means, electronic or mechanical, including photocopying and recording, or any information storage or retrieval system, or otherwise, without the prior written permission of SANYO Electric Co., Ltd.
- Any and all information described or contained herein are subject to change without notice due to product/technology improvement, etc. When designing equipment, refer to the "Delivery Specification" for the SANYO product that you intend to use.
- Information (including circuit diagrams and circuit parameters) herein is for example only ; it is not guaranteed for volume production. SANYO believes information herein is accurate and reliable, but no guarantees are made or implied regarding its use or any infringements of intellectual property rights or other rights of third parties.

This catalog provides information as of January, 2001. Specifications and information herein are subject to change without notice.