

**SANYO**

No.863E

**LB8050**Intermittent Windshield  
Wiper Controller**Applications**

Intermittent window wiper, seat belt warning lamp, ajar door warning lamp, timer, Schmitt circuit

**Features**

Performs all functions required for intermittent wipers.

- Any intermittent time settable
- Delayed wipe coupled with washer operation
- 1 to 2 wipes immediately after turning on intermittent switch
- Relay direct driving capability (500mA peak)
- Wide operating voltage range : 8.0 to 16.0V

**Absolute Maximum Ratings at Ta = 25°C**

			unit
Maximum Supply Voltage	V <sub>CC</sub> max	16	V
Maximum Output Voltage	V <sub>OUT</sub> max	18	V
Maximum Output Current	I <sub>O</sub> max1	Output : Darlington connection	See Fig.A.
	I <sub>O</sub> max2	Output : Not Darlington connection	See Fig.B.
Output Surge Current	I <sub>O</sub> surge	Pulse width : 5msec. or less, repeat cycle : 1sec. or more, V <sub>CC</sub> = 8 to 16V, Ta = -30 to +80°C	1000 mA
Allowable Power Dissipation	Pd max	See Fig.C.	690 mW
Storage Temperature	Topr	-50 to +125	°C
Operating Temperature	Topg	-30 to +80	°C

**Allowable Operating Range at Ta = 25°C**

		unit
Operating Voltage Range	V <sub>CC</sub>	12 ± 4 V

**Electrical Characteristics at Ta = 25°C, V<sub>CC</sub> = 16V**

			Test				
unless otherwise specified			Circuit	min	typ	max	unit
Output Current	I <sub>OH1</sub>	V <sub>IN</sub> = 5V, V <sub>WA</sub> = 2V, V <sub>WI</sub> = 0V, V <sub>OH</sub> = 16V	1			100	μA
	I <sub>OH2</sub>	V <sub>IN</sub> = 5V, V <sub>WA</sub> = 2V, V <sub>WI</sub> = 0V, V <sub>OH</sub> = 16V	1			100	μA
Output 'L'-Level	V <sub>OL1</sub>	V <sub>CC</sub> = 6.4V, I <sub>O1</sub> = 0.3A, I <sub>O2</sub> = 4mA, V <sub>WA</sub> = 0V, V <sub>WI</sub> = 0V	2			2.1	V
	V <sub>OL2</sub>	V <sub>CC</sub> = 6.4V, I <sub>O1</sub> = 0.3A, I <sub>O2</sub> = 4mA, V <sub>WA</sub> = 0V, V <sub>WI</sub> = 0V	2			1.6	V

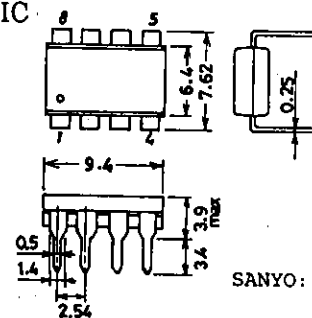
**Package Dimensions 3001B-D8IC**  
(unit: mm)

Continued on next page.

SANYO: DIP8

**SANYO Electric Co., Ltd. Semiconductor Business Headquarters**  
TOKYO OFFICE Tokyo Bldg., 1-10, 1 Chome, Ueno, Taito-ku, TOKYO, 110 JAPAN

Continued from preceding page.

			Test Circuit	min	typ	max	unit
Input 'H'-Level	$V_{IH1}$	$I_{WA} = 50\mu A, V_{WI} = 0V$	3	4.7		6.8	V
	$V_{IH2}$	$I_{IN} = -1mA, V_{WA} = V_{WI} = 0V$	4	13.2		15.4	V
	$V_{IH3}$	$I_{IN} = -1mA, V_{WI} = 2V, V_{WA} = 0V$	5	13.2		15.4	V
	$V_{IH4}$	$I_{IN} = -1mA, V_{WA} = V_{WI} = 2V$	6	5.6		8.6	V
Input Current	$I_{IH1}$	$V_{IN} = 7V, V_{WA} = 2V, V_{WI} = 0V$	7			20	$\mu A$
	$I_{IH2}$	$V_{CC} = 6.4V, V_{IN} = 2.2V, V_{WI} = 0V$	8			2	$\mu A$
	$I_{WA}$	$V_{WA} = 10V$	9	5		10	mA
	$I_{WI}$	$V_{WI} = 10V$	10	5		10	mA
Supply Current	$I_{CC1 ON}$	$V_{WA} = V_{WI} = 0V$	11	5		13	mA
	$I_{CC2 OFF}$	$V_{WA} = V_{WI} = 2V$	12	4		9	mA
	$I_{CC3 OFF}$	$V_{WA} = 2V, V_{WI} = 0V$	13	4		8.5	mA

Test Circuits

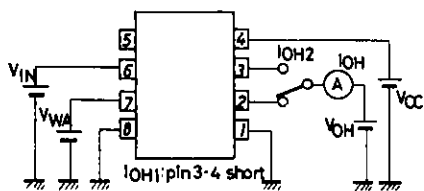

Test Circuit 1 :  $I_{OH1}, I_{OH2}$

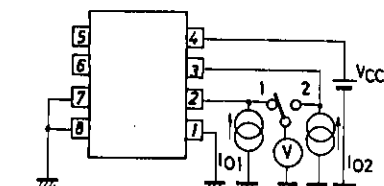

Test Circuit 2 :  $V_{OL1}, V_{OL2}, SW_1, SW_2$

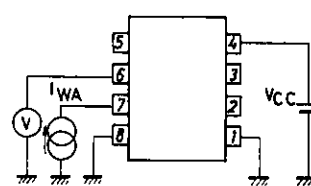

Test Circuit 3 :  $V_{IH1}$

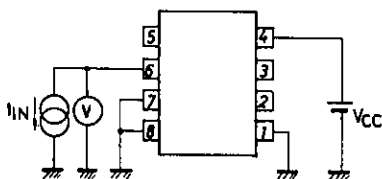

Test Circuit 4 :  $V_{IH2}$

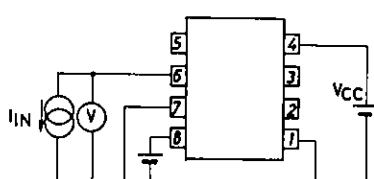

Test Circuit 5 :  $V_{IH3}$

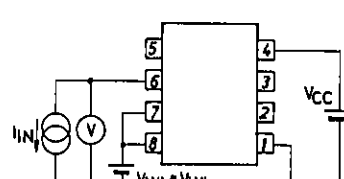

Test Circuit 6 :  $V_{IH4}$

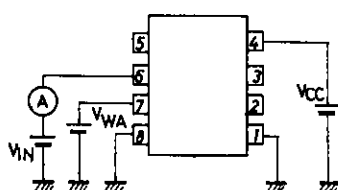

Test Circuit 7 :  $I_{IH1}$

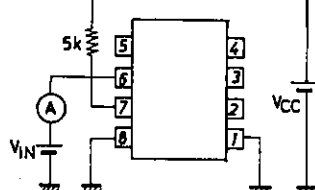

Test Circuit 8 :  $I_{IH2}$

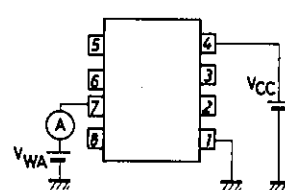

Test Circuit 9 :  $I_{WA}$

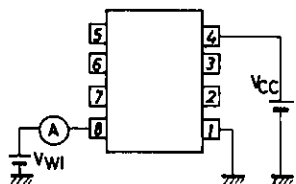

Test Circuit 10 :  $I_{WI}$

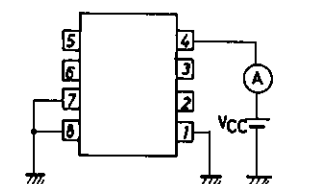

Test Circuit 11 :  $I_{CC1 ON}$

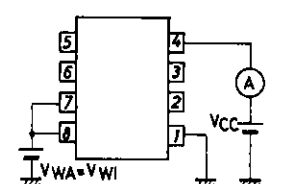

Test Circuit 12 :  $I_{CC2 OFF}$

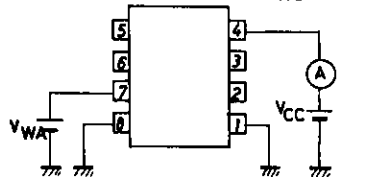

Test Circuit 13 :  $I_{CC3 OFF}$

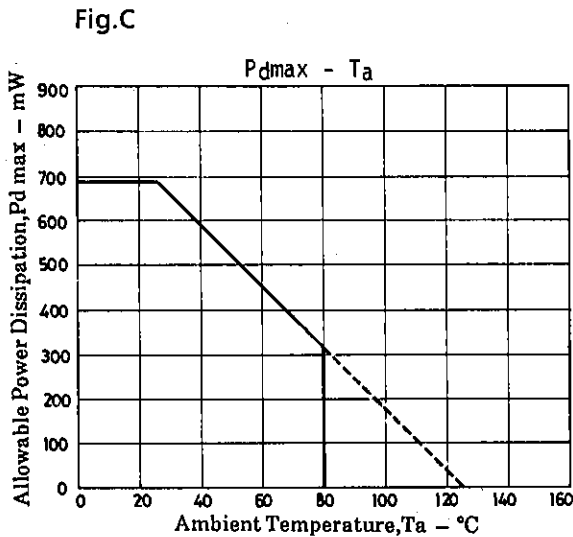
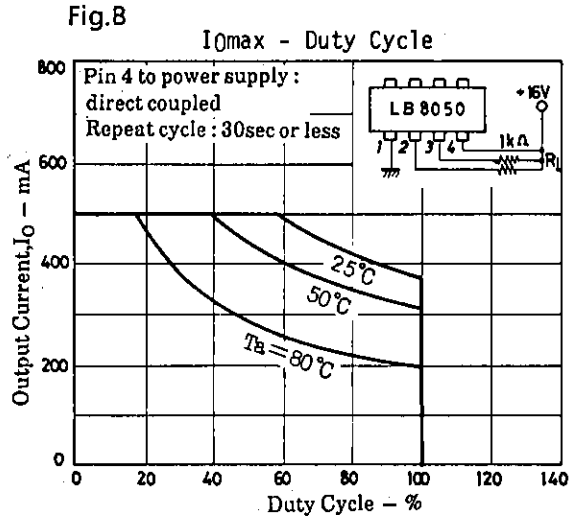
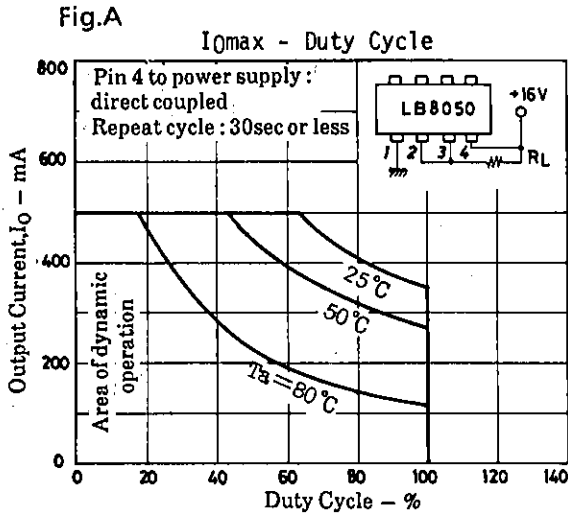

**Equivalent Circuit and Block Diagram**

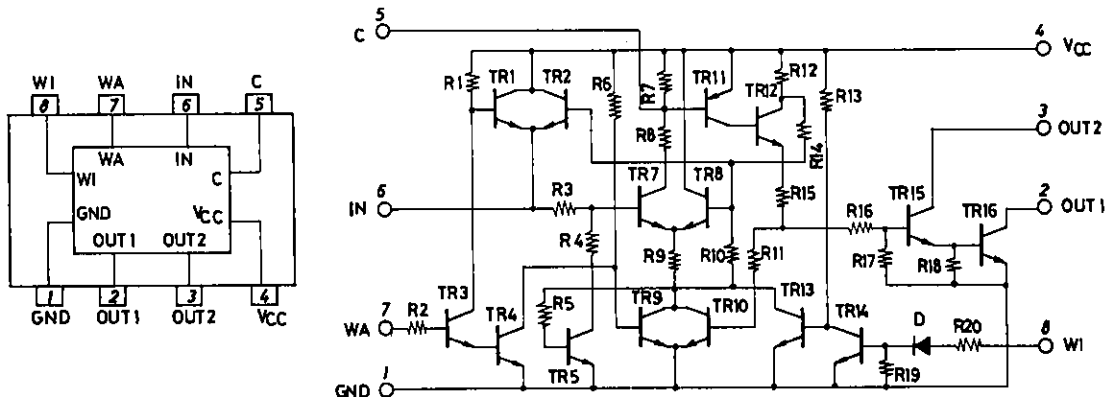

Sample Application Circuit : Asynchronous intermittent wiper control

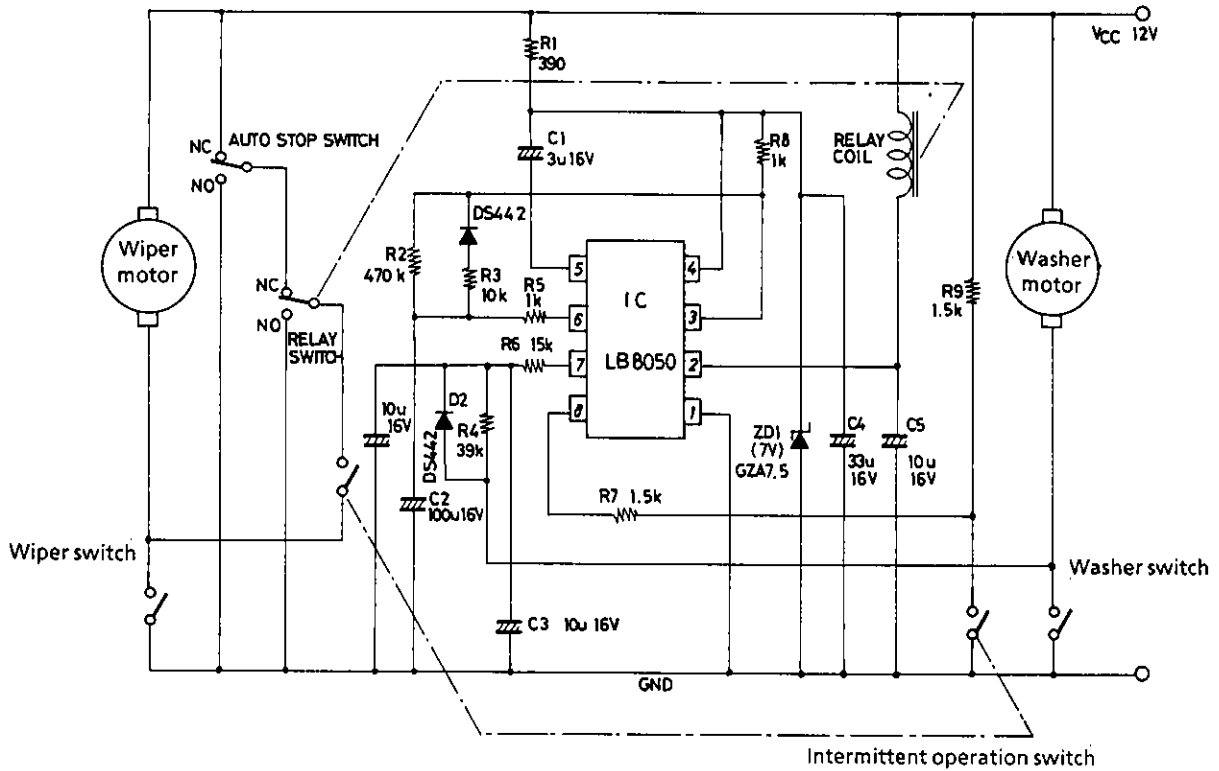

Unit (resistance:  $\Omega$ , capacitance: F)

- No products described or contained herein are intended for use in surgical implants, life-support systems, aerospace equipment, nuclear power control systems, vehicles, disaster/crime-prevention equipment and the like, the failure of which may directly or indirectly cause injury, death or property loss.
- Anyone purchasing any products described or contained herein for an above-mentioned use shall:
  - ① Accept full responsibility and indemnify and defend SANYO ELECTRIC CO., LTD., its affiliates, subsidiaries and distributors and all their officers and employees, jointly and severally, against any and all claims and litigation and all damages, cost and expenses associated with such use.
  - ② Not impose any responsibility for any fault or negligence which may be cited in any such claim or litigation on SANYO ELECTRIC CO., LTD., its affiliates, subsidiaries and distributors or any of their officers and employees jointly or severally.
- Information (including circuit diagrams and circuit parameters) herein is for example only; it is not guaranteed for volume production. SANYO believes information herein is accurate and reliable, but no guarantees are made or implied regarding its use or any infringements of intellectual property rights or other rights of third parties.