

SANYO

No. 3860

LC7368J**Switchable DTMF/Pulse Dialer****OVERVIEW**

The LC7368J is a CMOS switchable DTMF/pulse dialer IC for European telephone handsets. It incorporates a 31-digit key buffer memory to support a redial function.

The LC7368J is powered by the telephone network; no external supply is needed. It can be connected directly to conventional 2-of-8 or single-contact keypads. It features a debounce circuit to prevent undesired keystrokes and an on-chip oscillator designed for use with a low-cost, color-burst crystal resonator.

The LC7368J supports mixed pulse/tone dialing. The contact make ratio and pulse rate are both user-selectable. A key-touch tone is output for each valid keystroke in pulse mode. A hookflash function is also provided.

The LC7368J operates from a 1.5 to 6.0 V supply and is available in 22-pin shrink DIPs.

FEATURES

- No external supply needed.
- 31-digit key buffer memory supports redial function.
- Connects directly to single contact or conventional 2-of-8 keypads.
- On-chip key-debounce circuit
- On-chip oscillator designed for use with a low-cost, color-burst crystal resonator
- Mode change key and pulse/tone inputs
- Supports mixed mode dialing.
- 12 tones for dual-tone multifrequency (DTMF) operation
- Pause entries are stored in key buffer memory.
- Hookflash function
- User-selectable contact make ratio and pulse rate
- Key-touch tone output in pulse mode
- 1.5 to 6.0 V supply
- 22-pin shrink DIP

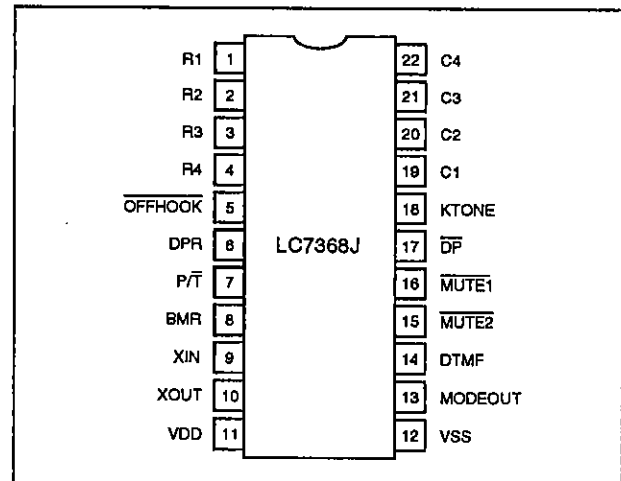
PINOUT**PACKAGE DIMENSIONS**

Unit: mm

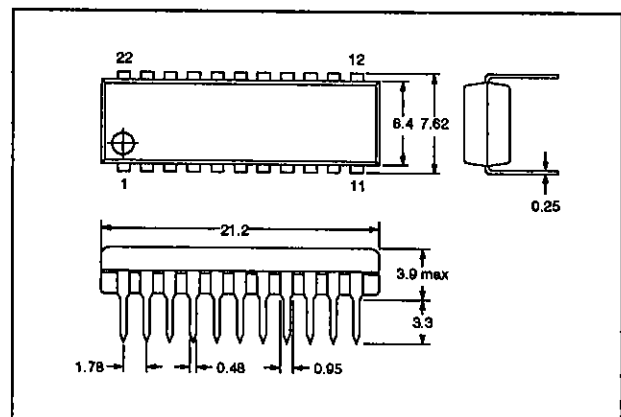
3059-DIP22S

BLOCK DIAGRAM

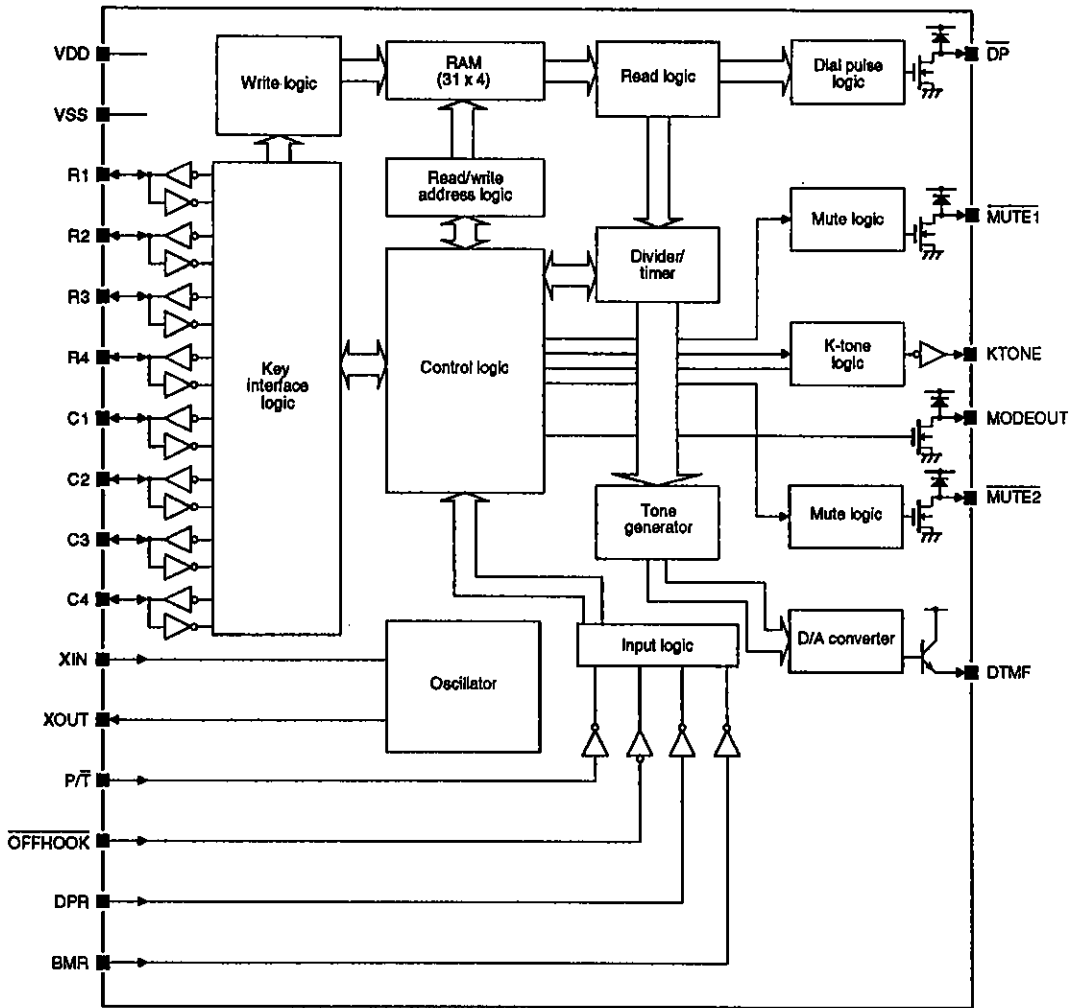

PIN DESCRIPTION

Number	Name	Equivalent circuit	Description
1 to 4	R1 to R4		Active-HIGH keypad row inputs. Input p-channel transistors are OFF and n-channel transistors are ON when the handset is on-hook.
5	OFFHOOK		Hook-switch input
6	DPR		Dial pulse rate input
7	P/T		Pulse/tone input
8	BMR		Break/make ratio input

LC7368J

Number	Name	Equivalent circuit	Description
9	XIN		Crystal or ceramic resonator connections
10	XOUT		
11	VDD		1.5 to 6.0 V supply
12	VSS		Ground
13	MODEOUT		Dialing mode output
14	DTMF		DTMF output. npn-transistor emitter follower
15	$\overline{\text{MUTE2}}$		DTMF mode mute output. Wire-ORed with $\overline{\text{MUTE1}}$
16	$\overline{\text{MUTE1}}$		Pulse mode mute output. Wire-ORed with $\overline{\text{MUTE2}}$
17	$\overline{\text{DP}}$		Pulse dialing output
18	KTONE		Key-touch tone output
19 to 22	C1 to C4		Active-HIGH keypad column inputs. Input p-channel transistors are OFF and n-channel transistors are ON when the handset is on-hook.

SPECIFICATIONS

Absolute Maximum Ratings

Parameter	Symbol	Rating	Unit
Supply voltage range	V_{DD}	-0.3 to 7	V
Input voltage range	V_I	-0.3 to $V_{DD} + 0.3$	V
Output voltage range	V_O	-0.3 to $V_{DD} + 0.3$	V

LC7368J

Parameter	Symbol	Rating	Unit
Minimum load resistance	R_L min	100	Ω
Power dissipation	P_D	300	mW
Operating temperature range	T_{opr}	-30 to 70	$^{\circ}\text{C}$
Storage temperature range	T_{stg}	-40 to 125	$^{\circ}\text{C}$

Recommended Operating Conditions

$T_a = 25\text{ }^{\circ}\text{C}$

Parameter	Symbol	Rating	Unit
Pulse mode supply voltage range	V_{DDP}	1.5 to 6.0	V
DTMF mode supply voltage range	V_{DDT}	2 to 6	V

Electrical Characteristics

$V_{DD} = 1.5$ to 6.0 V, $T_a = 25\text{ }^{\circ}\text{C}$

Parameter	Symbol	Condition	Rating			Unit
			min	typ	max	
LOW-level input voltage	V_{IL}		V_{SS}	-	$0.3V_{DD}$	V
HIGH-level input voltage	V_{IH}		$0.7V_{DD}$	-	V_{DD}	V
Key contact resistance	R_{K1}		-	-	3.0	k Ω
Key capacitance	C_{K1}		-	-	330	pF
Pulse mode supply current	I_{DDP}	Output open, $V_{DD} = 3.5$ V	-	0.3	0.5	mA
DTMF mode supply current	I_{DDT}	Output open, $V_{DD} = 3.5$ V	-	0.5	1.0	mA
Quiescent current	I_{DD}	$V_{OFFHOOK} = V_{DD}$, outputs open	-	-	1	μA
Minimum supply voltage for data retention	V_{DR}		-	-	1	V
Minimum supply current for data retention	I_{DR}	$V_{DD} = 1$ V	-	-	0.5	μA
OFFHOOK, DPR, PT and BMR LOW-level input current	I_{IL}	$V_{IL} = V_{SS}$	-1	-	-	μA
OFFHOOK, DPR, PT and BMR HIGH-level input current	I_{IH}	$V_{IH} = V_{DD}$	-	-	1	μA
Key input current	I_{HK}	$V_{DD} = 1.5$ V, $V_{IH} = V_{DD}$	-	-	20	μA
		$V_{DD} = 6.0$ V, $V_{IH} = V_{DD}$	-	-	300	
Key output current	I_{OK}	$V_{DD} = 1.5$ V, $V_{OH} = 0.8V_{DD}$	-	-	-50	μA
		$V_{DD} = 6.0$ V, $V_{OH} = 0.8V_{DD}$	-	-	-700	
DP, MUTE1, MUTE2 and MODEOUT leakage current	I_{OFF}	Outputs open, $V_O = V_{DD} = 6.0$ V	-	-	1	μA

LC7368J

Parameter	Symbol	Condition	Rating			Unit
			min	typ	max	
KTONE HIGH-level output voltage	V _{OH}	V _{DD} = 1.5 V, I _{OH} = -125 μA	V _{DD} - 0.5	-	-	V
		V _{DD} = 3.5 V, I _{OH} = -500 μA	V _{DD} - 1.0	-	-	
KTONE, DP, MUTE1, MUTE2 and MODEOUT LOW-level output voltage	V _{OL}	V _{DD} = 1.5 V, I _{OL} = 125 μA	-	-	0.4	V
		V _{DD} = 3.5 V, I _{OL} = 500 μA	-	-	0.4	

Dialing

V_{DD} = 1.5 to 6.0 V, T_a = 25 °C, f_{osc} = 3.579545 MHz

Parameter	Symbol	Condition	Rating			Unit
			min	typ	max	
Key debounce time	t _{kd}		10.8	-	11.6	ms
Key-touch tone frequency	f _{kt}		-	621.5	-	Hz
Key-touch tone burst pulsewidth	t _{kt}		-	50.9	-	ms
Autopause time	t _{ap}		-	2.08	-	s
Single tone rms output voltage	V _{OR}	V _{DD} = 3.5 V, R _L = 10 kΩ	170	205	245	mV
Tone output ratio	d _{BCR}	V _{DD} = 2 to 6 V, R _L = 10 kΩ	1	2	3	dB
Tone output distortion	DIS	V _{DD} = 2.5 to 6.0 V, R _L = 10 kΩ, f = 300 to 3400 Hz	-	-	7	%
		V _{DD} = 2 to 6 V, R _L = 10 kΩ, f = 300 to 3400 Hz	-	-	10	
Oscillator start delay	t _{start}	V _{DD} = 1.7 to 6.0 V	-	-	20	ms
		V _{DD} = 3.5 V	-	-	8	
DTMF burst pulsewidth	t _{MFOH}		97.6	-	-	ms
DTMF interdigit delay	t _{MFOFF}		100.6	-	-	ms
Hookflash pulsewidth	t _{flash}		-	103.8	-	ms

Resonator

V_{DD} = 1.5 to 6.0 V, T_a = 25 °C

Parameter	Symbol	Rating	Unit
Resonator frequency	f _{osc}	3.579545	MHz
Resonator resistance	R _s	100	Ω

Dial pulse output

$V_{DD} = 1.5$ to 6.0 V, $T_a = 25$ °C, $f_{osc} = 3.579545$ MHz

DPR	BMR	Dial pulse rate (pps)	Interdigit pause (ms)	Make ratio (%)
V _{SS}	V _{DD}	9.94	838.1	33.2
V _{DD}	V _{DD}	19.89	519.6	33.2
V _{SS}	V _{SS}	9.94	844.8	40
V _{DD}	V _{SS}	19.89	623.0	40

Redial function

$f_{osc} = 3.579545$ MHz

Parameter	First digit interval (ms)	Second and subsequent digit interval (ms)
DTMF output	97.6	100.6
Interdigit pause	100.6	100.6
Period	198.2	201.2

Dual-tone multifrequency

$V_{DD} = 2$ to 6 V, $T_a = 25$ °C, $f_{osc} = 3.579545$ MHz

Pin name	Output frequency comparison		Deviation (%)
	Specification (Hz)	LC7368J (Hz)	
R1	697	699.1	0.30
R2	770	766.2	-0.49
R3	852	847.4	-0.54
R4	941	948.0	0.74
C1	1209	1215.9	0.57
C2	1336	1331.7	-0.32
C3	1477	1471.9	-0.35

Timing Diagrams

Pulse dialing

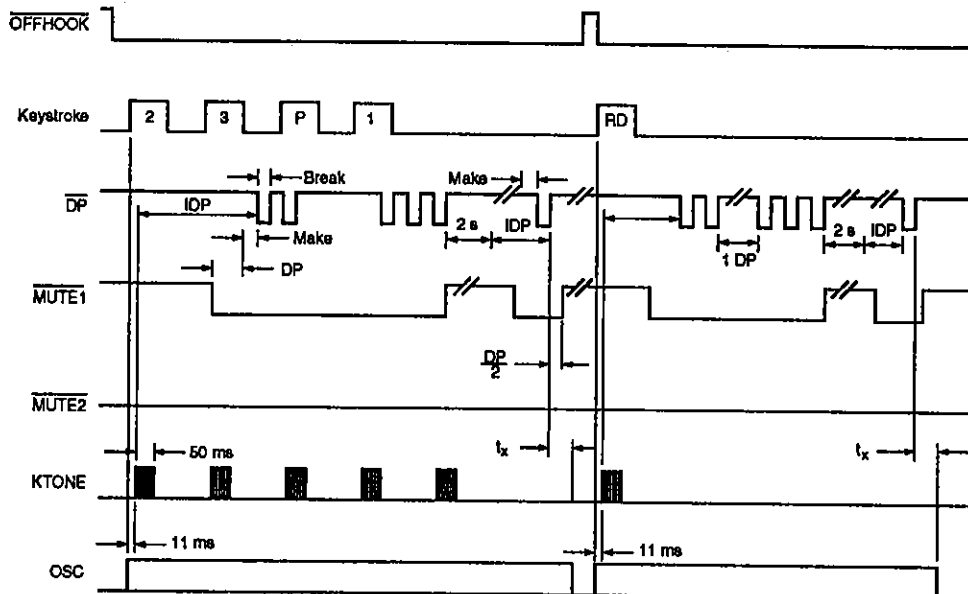

$$t_x = 800 - \left[\left(1 - \frac{10}{DP} \right) \times 600 \right] + \left(\frac{\text{Make ratio}}{DP} \times 10 \right) + DP \text{ ms}$$

$$DP = \frac{1000}{\text{Dial pulse ratio}} \text{ ms}$$

Tone dialing

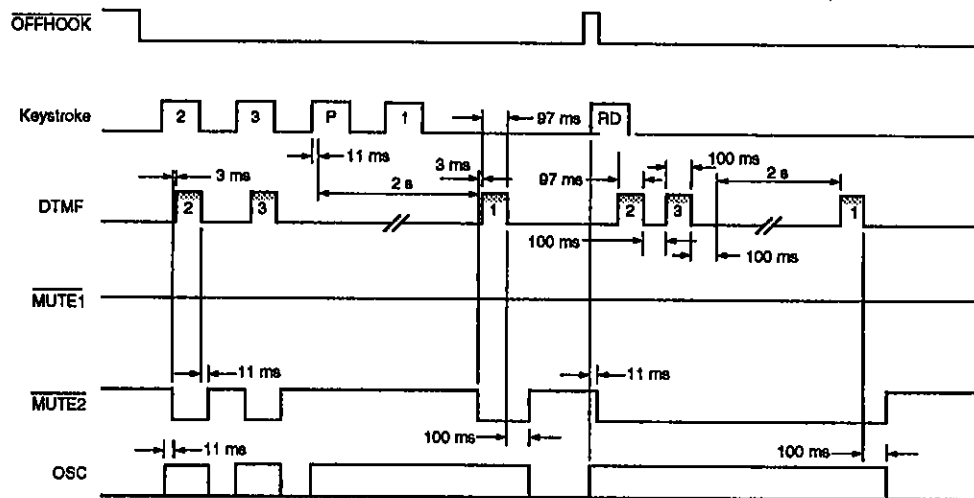

Pulse-to-tone dialing 1

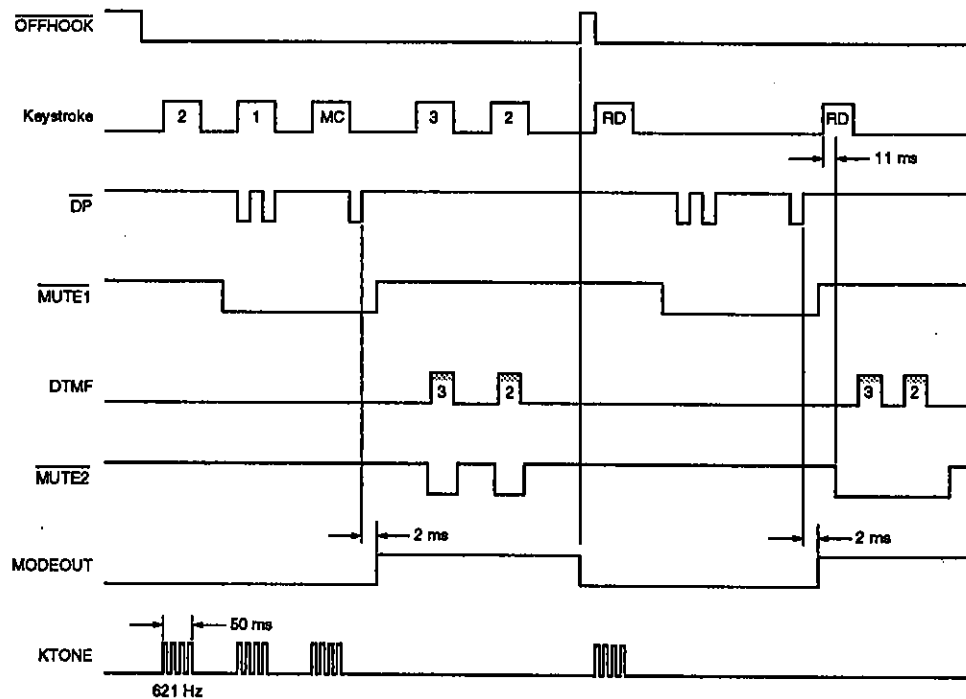

Pulse-to-tone dialing 2

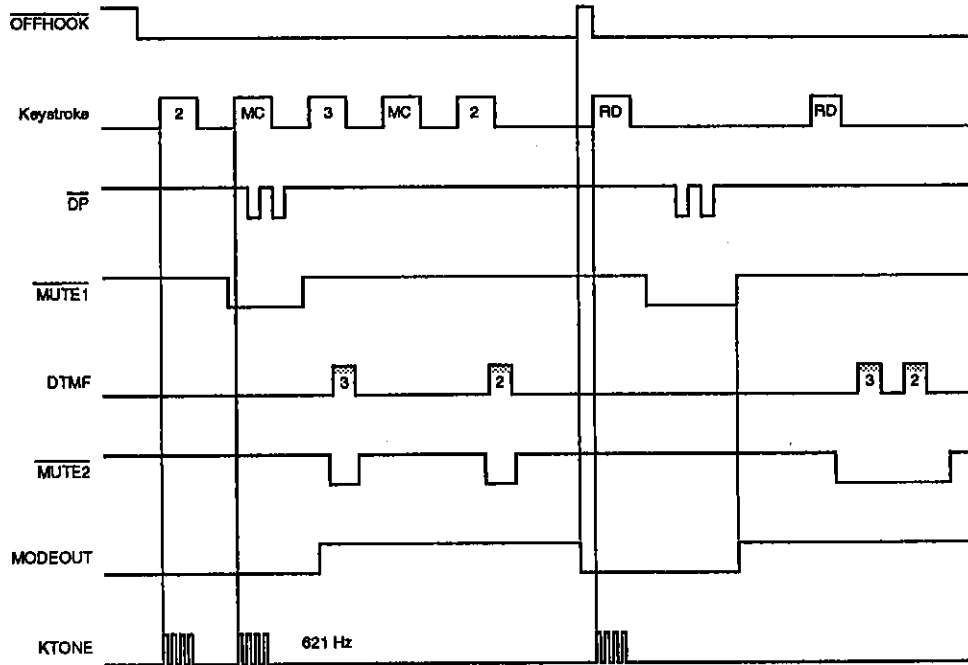

Note
 Second and subsequent MC keystrokes are ignored.

Flash timing

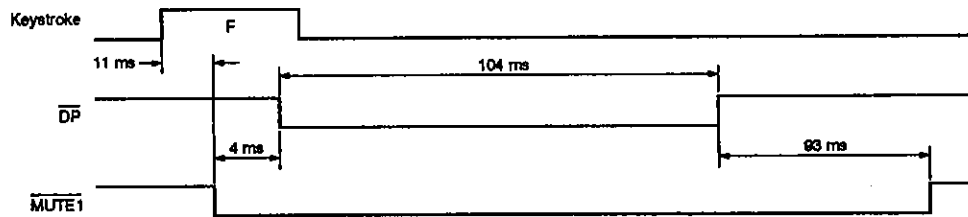

Note
 When MUTE1 goes HIGH, the state is the same as that after off-hook.

Mixed mode dialing

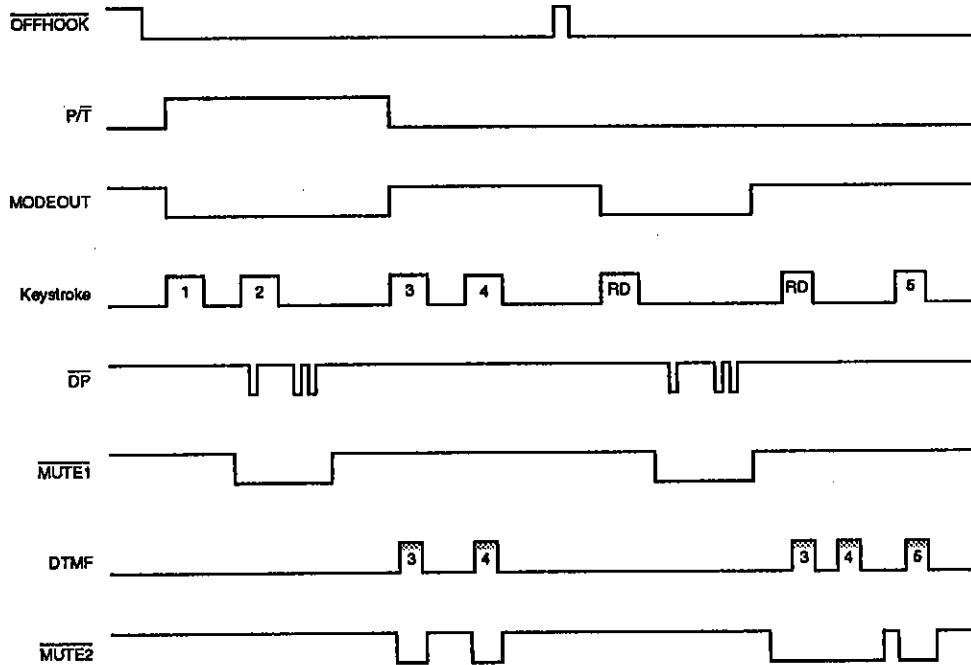

Key debounce timing

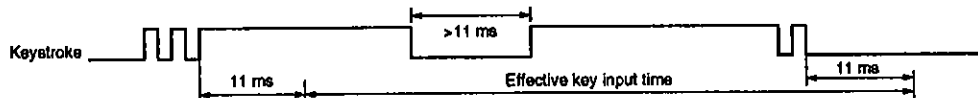

FUNCTIONAL DESCRIPTION

The LC7368J supports pulse, tone and mixed pulse/tone dialing modes.

Circuit Operation

When the handset is off-hook, $\overline{\text{OFFHOOK}}$ is LOW, and when on-hook, $\overline{\text{OFFHOOK}}$ is HIGH.

The internal key buffer memory stores up to 31 digits. The memory contents are read at the preselected dial rate and are output to either the pulse pin ($\overline{\text{DP}}$) when in pulse mode or the tone pin (DTMF) when in tone mode. The key buffer memory is also used for the redial function. If more than 31 successive digits are entered, the digits overwrite the memory starting from the first location, allowing dialing of any number of digits. However, the redial function is no longer supported after the original contents have been overwritten.

The key buffer memory stores dialing digits, and *, #, mode change (MC) and pause (P) keystrokes. Each digit and keystroke occupies a single memory location. The dialing mode can be changed by either pressing the MC key or changing the state of the P/T input.

Pressing the P key suspends dialing output for 2 s. Pressing the redial (RD) key causes the most recently entered key combination to be redialed.

Output Circuitry

Pulse dialing output is selected when MODEOUT is LOW, and dialing mode output, when MODEOUT is HIGH.

The $\overline{\text{DP}}$, $\overline{\text{MUTE1}}$, $\overline{\text{MUTE2}}$ and MODEOUT outputs are open-drain, n-channel transistor outputs. Each output is in the high-impedance state when the output transistor is OFF, shown in the timing diagrams as a HIGH-level. The DTMF output is an emitter-follower. It is in the high-impedance state when the output transistor is OFF, shown in the timing diagrams as a LOW-level.

In pulse dialing mode, a key-touch tone is output on KTONE for each valid keystroke.

Key Functions

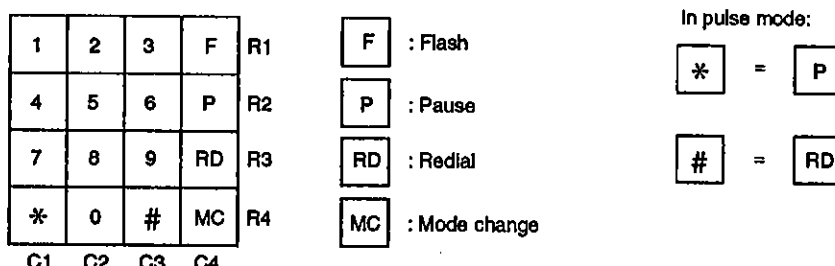

Figure 1. Keypad layout

0 to 9 keys

The 0 to 9 keys are dialing digits which are stored in the key buffer memory.

*** and # keys**

In tone dialing mode, the * and # keys are legitimate dialing digits and are stored in key buffer memory. In pulse dialing mode, the * and # keys have the same function as the pause (P) and redial (RD) keys, respectively. However, only the * key is stored in key buffer memory.

F key

The flash (F) key can be used to generate a 0.1 s hookflash, suspending the current call to allow another number to be dialed.

P key

The pause (P) key can be used to suspend dialing. Each keystroke generates a 2 s pause, which is stored in the key buffer memory.

RD key**Redial operation**

The redial (RD) key can be used to redial numbers of up to 31 digits after a hookflash or F key operation finishes. Note that the dialing mode last used during redial remains active after the current redial has completed. During a redial, all keystrokes, except the RD key during a pause and the F key, are ignored.

Pause release

Pauses generated by pressing either the pause (P) or mode change (MC) keys can be deactivated by pressing the redial (RD) key. A single RD keystroke deactivates all pauses in key buffer memory.

MC key

The mode change (MC) key can be used to change from pulse to tone dialing mode. Tone to pulse dialing mode changes are not supported by the MC key. An MC keystroke during or after pulse dialing is stored in key buffer memory. If the MC key is pressed immediately after the handset is lifted, dialing switches from pulse to tone mode and the keystroke is not stored in buffer memory.

An internal mode change flag is set when the MC key is pressed. It is cleared when either the handset is on-hook, the F key is pressed or the P/\bar{T} input changes state.

If a mode change (MC) keystroke is neither preceded nor followed by a pause (P) keystroke during manual dialing or redialing, then the dialing mode change is affected as follows.

- For manual dialing

- If tone-mode data is entered before pulse-mode data output finishes, then the device pauses indefinitely. The pause is then released and tone-mode dialing starts when the RD key is pressed.
- If tone-mode data is entered after pulse-mode data output finishes, then tone-mode dialing starts immediately.

- For redial

- The device pauses indefinitely. The pause is released and tone-mode dialing starts when the RD key is pressed.

Key Operation

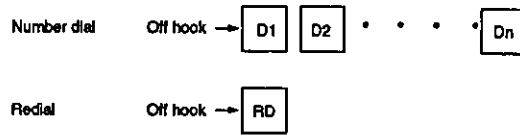

Figure 2. Normal dialing

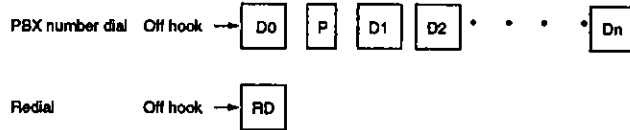

Figure 3. PBX dialing

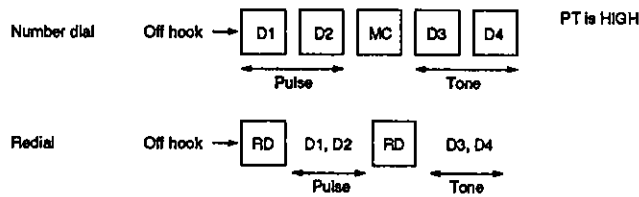

Figure 4. Pulse and tone dialing without pauses

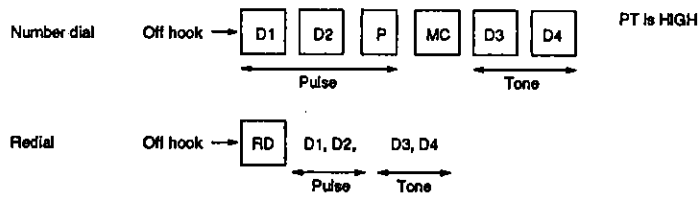

Figure 5. Pulse and tone dialing with pauses

- (a) In pulse mode P = * RD = #
- (b) Each pause is 2 seconds long. Press the P n times to generate a pause of 2 x n seconds.
- (c) The RD key can be used to de-activate pause mode. Multiple pauses are de-activated by a single key stroke.

Figure 6. Notes on key functions

Key Debounce Circuit

The LC7368J incorporates a key debounce circuit to prevent multiple entries from a single keystroke. A single keystroke is registered during an 11 ms debounce interval, and the key then has to be released for at least 11 ms before another keystroke can be registered.

Dialing Performance

The pulse contact make ratio is 40% when BMR is LOW, and 33.2%, when BMR is HIGH. The dial pulse rate is 10 pps when DPR is LOW, and 20 pps, when DPR is HIGH. Twelve different output tones are generated for the 0 to 9, * and # keys. Tone output continues as long as each key is depressed. The guaranteed minimum tone output pulsewidth is 100 ms.

Pulse/Tone Input

Tone dialing mode is selected when P/\bar{T} is LOW, and pulse dialing mode, when P/\bar{T} is HIGH. The P/\bar{T} input can be toggled during dialing for mixed mode dialing. Each keystroke is stored in the key buffer memory.

Oscillator

An on-chip feedback resistor and capacitor means that no external oscillator components are required. Note that 30 pF capacitors should be connected from XIN and XOUT to ground if a ceramic resonator is used.

Test Mode

The LC7368J has a test mode which can be used to speed up testing. When test mode is active, the internal divider circuitry is bypassed. Keypad scanning and dial pulse rate are 72 times faster, and the pause interval, 72 times shorter, than in normal operating mode.

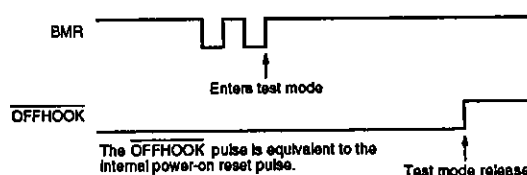

Figure 7. Test-mode timing

- No products described or contained herein are intended for use in surgical implants, life-support systems, aerospace equipment, nuclear power control systems, vehicles, disaster/crime-prevention equipment and the like, the failure of which may directly or indirectly cause injury, death or property loss.
- Anyone purchasing any products described or contained herein for an above-mentioned use shall:
 - ① Accept full responsibility and indemnify and defend SANYO ELECTRIC CO., LTD., its affiliates, subsidiaries and distributors and all their officers and employees, jointly and severally, against any and all claims and litigation and all damages, cost and expenses associated with such use:
 - ② Not impose any responsibility for any fault or negligence which may be cited in any such claim or litigation on SANYO ELECTRIC CO., LTD., its affiliates, subsidiaries and distributors or any of their officers and employees jointly or severally.
- Information (including circuit diagrams and circuit parameters) herein is for example only; it is not guaranteed for volume production. SANYO believes information herein is accurate and reliable, but no guarantees are made or implied regarding its use or any infringements of intellectual property rights or other rights of third parties.

LC7368J

APPLICATION CIRCUIT

