



Photoelectric Smoke Detector IC with I/O For Line-Powered Applications

The CMOS MC145011 is an advanced smoke detector component containing sophisticated very-low-power analog and digital circuitry. The IC is used with an infrared photoelectric chamber. Detection is accomplished by sensing scattered light from minute smoke particles or other aerosols. When detection occurs, a pulsating alarm is sounded via on-chip push-pull drivers and an external piezoelectric transducer.

The variable-gain photo amplifier allows direct interface to IR detectors (photo-diodes). Two external capacitors C1 and C2, C1 being the larger, determine the gain settings. Low gain is selected by the IC during most of the standby state. Medium gain is selected during a local-smoke condition. High gain is used during push button test. During standby, the special monitor circuit which periodically checks for degraded chamber sensitivity uses high gain, also.

The I/O pin, in combination with VSS, can be used to interconnect up to 40 units for common signaling. An on-chip current sink provides noise immunity when the I/O is an input. A local-smoke condition activates the short-circuit-protected I/O driver, thereby signaling remote smoke to the interconnected units. Additionally, the I/O pin can be used to activate escape lights, enable auxiliary or remote alarms, and/or initiate auto-dialers.

While in standby, the low-supply detection circuitry conducts periodic checks using a load current from the LED pin. The trip point is set using two external resistors. The supply for the MC145011 must be a dc power source capable of supplying 35 mA continuously and 45 mA peak. When the MC145011 is in standby, an external LED is continuously illuminated to indicate that the device is receiving power.

An extinguished LED accompanied by a pulsating audible alarm indicates a local-smoke condition. A pulsating audible alarm with the LED illuminated indicates a remote-smoke condition. A beep or chirp indicates a low-supply condition or degraded chamber sensitivity. A low-supply condition does not affect the smoke detection capability if $V_{DD} \geq 6$ V. Therefore, the low-supply condition and degraded chamber sensitivity can be distinguished by performing a push button (chamber) test. This circuit is designed to operate in smoke detector systems that comply with UL217 and UL268 specifications.

Features

- Operating Voltage Range: 6 to 12 V
- Operating Temperature Range: -10 to 60°C
- Average Standby Supply Current (Visible LED Illuminated): 20 mA
- Power-On Reset Places IC in Standby Mode (Non-Alarm State)
- Electrostatic Discharge (ESD) and Latch Up Protection Circuitry on All Pins
- Chip Complexity: 2000 FETs, 12 NPNs, 16 Resistors, and 10 Capacitors
- Pb-Free Packaging Designated by Suffix Code ED

ORDERING INFORMATION

Device	Package
MC145011P	Plastic Dip
MC145011ED	
MCZ145011DW	SOIC Package

MC145011

PHOTOELECTRIC SMOKE DETECTOR IC WITH I/O FOR LINE-POWERED APPLICATIONS

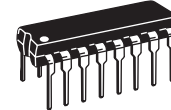

**P SUFFIX
ED SUFFIX (PB-FREE)
PLASTIC DIP
CASE 648-08**

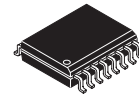

**DW SUFFIX
PLASTIC SOIC
CASE 751G-04**

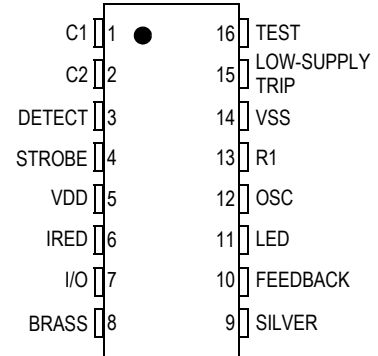
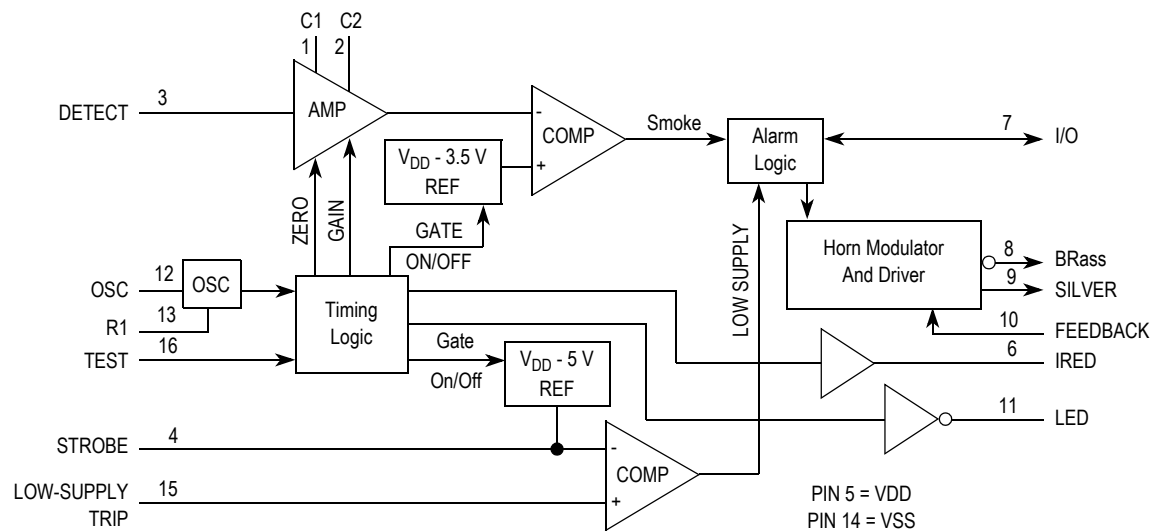

Figure 1. Pin Connections

Freescale Semiconductor, Inc. reserves the right to change the detail specifications, as may be required, to permit improvements in the design of its products.

Archive Information

Archive Information

Figure 2. Block Diagram
Table 1. Maximum Ratings⁽¹⁾
 (Voltages referenced to V_{SS})

Parameter	Symbol	Value	Unit
DC Supply Voltage	V_{DD}	-0.5 to +12	V
DC Input Voltage	V_{IN}	-0.25 to $V_{DD} + 0.25$ -0.25 to $V_{DD} + 0.25$ -0.25 to $V_{DD} + 10$ -15 to +25 -1.0 to $V_{DD} + 0.25$	V
DC Input Current, per Pin	I_{IN}	± 10	mA
DC Output Current, per Pin	I_{OUT}	± 25	mA
DC Supply Current, V_{DD} and V_{SS} Pins	I_{DD}	+25 / -150	mA
Power Dissipation in Still Air	P_D	1200 ⁽²⁾ 350 ⁽³⁾	mW
Storage Temperature	T_{STG}	-55 to +125	$^{\circ}C$
Lead Temperature, 1 mm from Case for 10 Seconds	T_L	260	$^{\circ}C$

- Maximum Ratings are those values beyond which damage to the device may occur. Functional operation should be restricted to the limits in the Electrical Characteristics tables.
- Derating: -12 mW/ $^{\circ}C$ from 25 $^{\circ}$ to 60 $^{\circ}C$.
- Derating: - 3.5 mW/ $^{\circ}C$ from 25 $^{\circ}$ to 60 $^{\circ}C$.

This device contains protection circuitry to guard against damage due to high static voltages or electric fields. However, precautions must be taken to avoid applications of any voltage higher than maximum rated voltages to this high-impedance circuit. For proper operation, V_{in} and V_{out} should be constrained to the range $V_{SS} \leq (V_{in} \text{ or } V_{out}) \leq V_{DD}$ except for the I/O, which can exceed V_{DD} , and the Test input, which can go below V_{SS} .

Unused inputs must always be tied to an appropriate logic voltage level (e.g., either V_{SS} or V_{DD}). Unused outputs and/or an unused I/O must be left open.

Table 2. Electrical Characteristics

 (T_A = -10 to 60°C Unless Otherwise Indicated, Voltages Referenced to V_{SS})

Characteristic	Symbol	Test Condition	V _{DD} /V _{DC}	Min	Max	Unit
Power Supply Voltage Range	V _{DD}		—	6.0	12	V
Supply Threshold Voltage, Low-Supply Alarm	V _{TH}	Low-Supply Trip: V _{IN} = V _{DD} /3	—	6.5	7.8	V
Average Operating Supply Current, Excluding the Visible LED Current (per Package)	I _{DD}	Standby Configured per Figure 8	12.0	—	12	μA
Peak Supply Current, Excluding the Visible LED Current (per Package)	I _{DD}	During Strobe On, I _{RED} Off Configured per Figure 8	12.0	—	2.0	mA
		During Strobe On, I _{RED} On Configured per Figure 8	12.0	—	3.0	
Low-Level Input Voltage I/O FEEDBACK Test	V _{IL}		9.0	—	1.5	V
			9.0	—	2.7	
			9.0	—	7.0	
High-Level Input Voltage I/O FEEDBACK Test	V _{IH}		9.0	3.2	—	V
			9.0	6.3	—	
			9.0	8.5	—	
Input Current OSC, DETECT LOW-SUPPLY TRIP FEEDBACK	I _{IN}	V _{IN} = V _{SS} or V _{DD}	12.0	—	±100	nA
		V _{IN} = V _{SS} or V _{DD}	12.0	—	±100	
		V _{IN} = V _{SS} or V _{DD}	12.0	—	±00	
Low-Level Input Current Test	I _{IL}	V _{IN} = V _{SS}	12.0	—	-1	μA
Pull-Down Current Test I/O	I _{IH}	V _{IN} = V _{DD}	9.0	0.5	10	μA
		No Local Smoke, V _{IN} = V _{DD}	9.0	25	100	
		No Local Smoke, V _{IN} = 17 V	12.0	—	140	
Low-Level Output Voltage LED SILVER, BRASS	V _{OL}	I _{OUT} = 10 mA	6.5	—	0.6	V
		I _{OUT} = 16 mA	6.5	—	1.0	
High-Level Output Voltage SILVER, BRASS	V _{OH}	I _{OUT} = -16 mA	6.5	5.5	—	V
Output Voltage (For Line Regulation, see Pin Descriptions)	V _{OUT}	Inactive, I _{OUT} = -1 μA Active, I _{OUT} = 100 μA to 500 μA (Load Regulation)	— 9.0	V _{DD} - 0.1 V _{DD} - 4.4	— V _{DD} - 5.6	V
		Inactive, I _{OUT} = 1 μA Active, I _{OUT} = 6 mA (Load Regulation)	— 9.0	— 2.25 ⁽¹⁾	0.1 3.75 ⁽¹⁾	
High-Level Output Current I/O	I _{OH}	Local Smoke, V _{OUT} = 4.5 V	6.5	-4	—	mA
		Local Smoke, V _{OUT} = V _{SS} (Short Circuit Current)	12.0	—	-16	
Off-State Output Leakage Current LED	I _{OZ}	V _{OUT} = V _{SS} or V _{DD}	12.0	—	±1	μA
Common Mode Voltage Range C1, C2, DETECT	V _{IC}	Local Smoke, Push button Test, or Chamber Sensitivity Test	—	V _{DD} - 4	V _{DD} - 2	V
Smoke Comparator Reference Voltage Internal	V _{ref}	Local Smoke, Push button Test, or Chamber Sensitivity Test	—	V _{DD} - 3.08	V _{DD} - 3.92	V

 1. T_A = 25°C only.

Table 3. AC Electrical Characteristics

 (Reference Timing Diagram [Figure 6](#) and [Figure 7](#)) ($T_A = 25^\circ\text{C}$, $V_{DD} = 9.0\text{ V}$, Component Values from [Figure 8](#): $R_1 = 100.0\text{ K}\Omega$, $C_3 = 1500.0\text{ pF}$, $R_2 = 10.0\text{ M}\Omega$)

No.	Characteristic	Symbol	Test Condition	Min	Max	Unit
1	Oscillator Period ⁽¹⁾	$1/f_{\text{OSC}}$	Free-Running Sawtooth Measured at Pin 12	9.5	11.5	ms
2	LED Status	t_{LED}	No Local Smoke, and No Remote Smoke	Illuminated		
3			Remote Smoke, but No Local Smoke	Illuminated		
4			Local Smoke or Push button Test	Extinguished		
5	STROBE Pulse Width	$t_{\text{W(STB)}}$		9.5	11.5	ms
6	IRED Pulse Period	t_{IRED}	Smoke Test	9.67	11.83	s
7			Chamber Sensitivity Test, without Local Smoke	38.9	47.1	
8			Push button Test	0.302	0.370	
9	IRED Pulse Width	$t_{\text{W(IRED)}}$		94	116	μs
10	IRED Rise Time	t_{R}		—	30	μs
	IRED Fall Time	t_{F}		—	200	
11	SILVER and BRASS Modulation Period	t_{MOD}	Local or Remote Smoke	297	363	ms
11, 12	SILVER and BRASS Duty Cycle	$t_{\text{ON}}/t_{\text{MOD}}$	Local or Remote Smoke	73	77	%
13	SILVER and BRASS Chirp Pulse Period	t_{CH}	Low Supply or Degraded Chamber Sensitivity	38.9	47.1	s
14	SILVER and BRASS Chirp Pulse Width	$t_{\text{W(CH)}}$	Low Supply or Degraded Chamber Sensitivity	9.5	11.5	ms
15	Rising Edge on I/O to Smoke Alarm Response Time	t_{RR}	Remote Smoke, No Local Smoke	—	800	ms
16	Strobe Pulse Period	t_{STB}	Smoke Test	9.67	11.83	s
17			Chamber Sensitivity Test, without Local Smoke	38.9	47.1	
18			Low Supply Test, without Local Smoke	38.9	47.1	
19			Push button Test	0.302	0.370	

1. Oscillator period $T (= T_R + T_F)$ is determined by the external components R_1 , R_2 , and C_3 where $T_R = (0.6931) R_2 C_3$ and $T_F = (0.6931) R_1 C_3$. The other timing characteristics are some multiple of the oscillator timing as shown in the table.

Table 4. Pin Description

Pin No.	Pin Name	Description
1	C1	A capacitor connected to this pin as shown in Figure 8 . determines the gain of the on-chip photo amplifier during push button test and chamber sensitivity test (high gain). The capacitor value is chosen such that the alarm is tripped from background reflections in the chamber during push button test. $A_V \approx 1 + (C1/10)$ where C1 is in pF. CAUTION: The value of the closed-loop gain should not exceed 10,000.
2	C2	A capacitor connected to this pin as shown in Figure 8 . determines the gain of the on-chip photo amplifier except during push button or chamber sensitivity tests. $A_V \approx 1 + (C2/10)$ where C2 is in pF. This gain increases about 10% during the IRED pulse, after two consecutive local smoke detections. Resistor R14 must be installed in series with C2. $R14 \approx [1/(12\sqrt{C2})] - 680$ where R14 is in ohms and C2 is in farads.
3	DETECT	This input to the high-gain pulse amplifier is tied to the cathode of an external photodiode. The photodiode should have low capacitance and low dark leakage current. The diode must be shunted by a load resistor and is operated at zero bias. The Detect input must be ac/dc decoupled from all other signals, VDD, and VSS. Lead length and/or foil traces to this pin must be minimized, also. See Figure 9 .

Table 4. Pin Description (Continued)

Pin No.	Pin Name	Description
4	STROBE	This output provides a strobed, regulated voltage referenced to V_{DD} . The temperature coefficient of this voltage is $\pm 0.2\%$ °C maximum from -10° to 60° C. The supply-voltage coefficient (line regulation) is $\pm 0.2\%/V$ maximum from 6 to 12 V. Strobe is tied to external resistor string R8, R9, and R10.
5	VDD	This pin is connected to the positive supply potential and may range from + 6 to + 12 V with respect to V_{SS} .
6	IRED	This output provides pulsed base current for external NPN transistor Q1 used as the infrared emitter driver. Q1 must have $\beta \geq 100$. At 10 mA, the temperature coefficient of the output voltage is typically $+0.5\%/^{\circ}$ C from -10° to 60° C. The supply-voltage coefficient (line regulation) is $\pm 0.2\%/V$ maximum from 6 to 12 V. The IRED pulse width (active-high) is determined by external components R1 and C3. With a 100 k Ω /1500 pF combination, the nominal width is 105 μ s. To minimize noise impact, IRED is not active when the visible LED and horn outputs are active. IRED is active near the end of Strobe pulses for Smoke Tests, Chamber Sensitivity Test, and Push button Test.
7	I/O	This pin can be used to connect up to 40 units together in a wired-OR configuration for common signaling. V_{SS} is used as the return. An on-chip current sink minimizes noise pick up during non-smoke conditions and eliminates the need for an external pull-down resistor to complete the wired-OR. Remote units at lower supply voltages do not draw excessive current from a sending unit at a higher supply voltage. I/O can also be used to activate escape lights, auxiliary alarms, remote alarms, and/or auto-dialers. As an input, this pin feeds a positive-edge-triggered flip-flop whose output is sampled nominally every 625 ms during standby (using the recommended component values). A local-smoke condition or the push button-test mode forces this current-limited output to source current. All input signals are ignored when I/O is sourcing current. If unused, I/O must be left unconnected.
8	BRASS	This half of the push-pull driver output is connected to the metal support electrode of a piezoelectric audio transducer and to the horn-starting resistor. A continuous modulated tone from the transducer is a smoke alarm indicating either local or remote smoke. A short beep or chirp is a trouble alarm indicating a low supply or degraded chamber sensitivity.
9	SILVER	This half of the push-pull driver output is connected to the ceramic electrode of a piezoelectric transducer and to the horn-starting capacitor.
10	FEEDBACK	This input is connected to both the feedback electrode of a self-resonating piezoelectric transducer and the horn-starting resistor and capacitor through current-limiting resistor R4. If unused, this pin must be tied to VSS or VDD.
11	LED	This active-low open-drain output directly drives an external visible LED. The load for the low-supply test is applied by this output. This low-supply test is non-coincident with the smoke tests, chamber sensitivity test, push button test, or any alarm signals. The LED also provides a visual indication of the detector status as follows, assuming the component values shown in Figure 8: Standby (includes low-supply and chamber sensitivity tests) - constantly illuminated Local Smoke - constantly extinguished Remote Smoke - constantly illuminated Push button Test - constantly extinguished (system OK); constantly illuminated (system problem)
12	OSC	This pin is used in conjunction with external resistor R2 (10 M Ω) to V_{DD} and external capacitor C3 (1500 pF) to V_{DD} to form an oscillator with a nominal period of 10.5 ms.
13	R1	This pin is used in conjunction with resistor R1 (100 k Ω) to pin 12 and C3 (1500 pF, see pin 12 description) to determine the IRED pulse width. With this RC combination, the nominal pulse width is 105 μ s.
14	VSS	This pin is the negative supply potential and the return for the I/O pin. Pin 14 is usually tied to ground.
15	LOW-SUPPLY TRIP	This pin is connected to an external voltage which determines the low-supply alarm threshold. The trip voltage is obtained through a resistor divider connected between the VDD and LED pins. The low-supply alarm threshold voltage (in volts) $\approx (5R7/R6) + 5$ where R6 and R7 are in the same units.
16	TEST	This input has an on-chip pull-down device and is used to manually invoke a test mode. The <i>Push button Test</i> mode is initiated by a high level at pin 16 (usually depression of a S.P.S.T. normally-open push button switch to V_{DD}). After one oscillator cycle, IRED pulses approximately every 336 ms, regardless of the presence of smoke. Additionally, the amplifier gain is increased by automatic selection of C1. Therefore, the background reflections in the smoke chamber may be interpreted as smoke, generating a simulated-smoke condition. After the second IRED pulse, a successful test activates the horn-driver and I/O circuits. The active I/O allows remote signaling for system testing. When the Push button Test switch is released, the Test input returns to V_{SS} due to the on-chip pull-down device. After one oscillator cycle, the amplifier gain returns to normal, thereby removing the simulated-smoke condition. After two additional IRED pulses, less than a second, the IC exits the alarm mode and returns to standby timing.

Archive Information

Archive Information

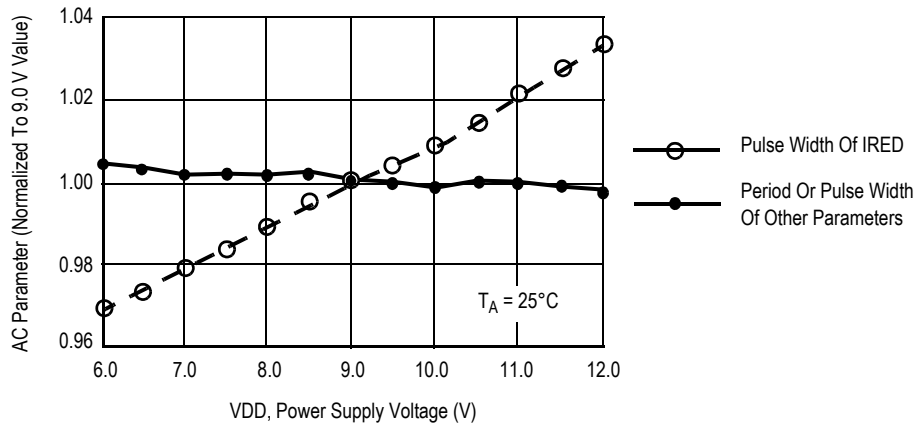
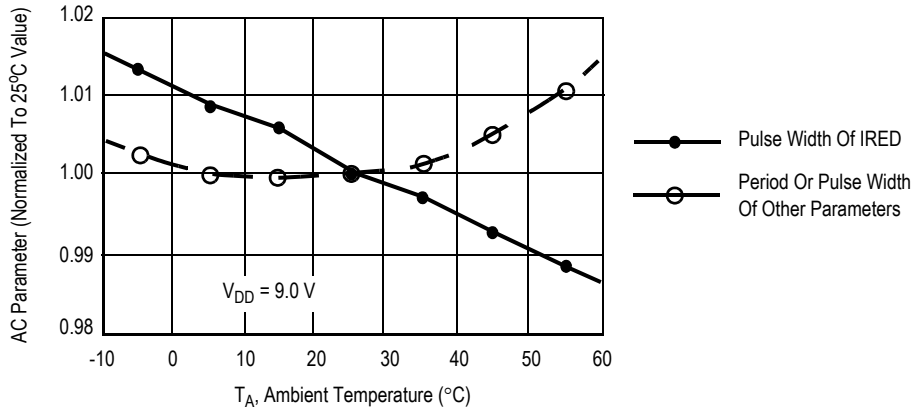

Figure 3. AC Characteristics versus Supply

 NOTE: Includes external component variations. See [Figure 5](#).

Figure 4. AC Characteristics versus Temperature

 NOTE: These components were used to generate [Figure 4](#).

Figure 5. RC Component Variation Over Temperature

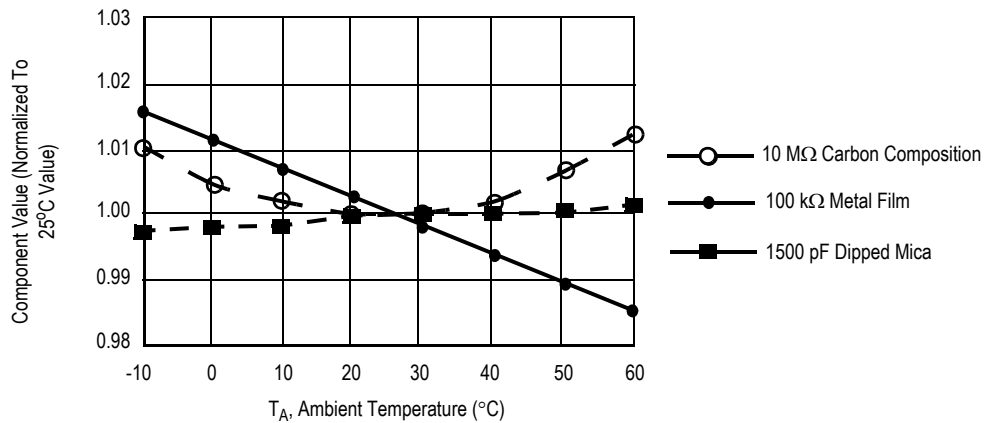
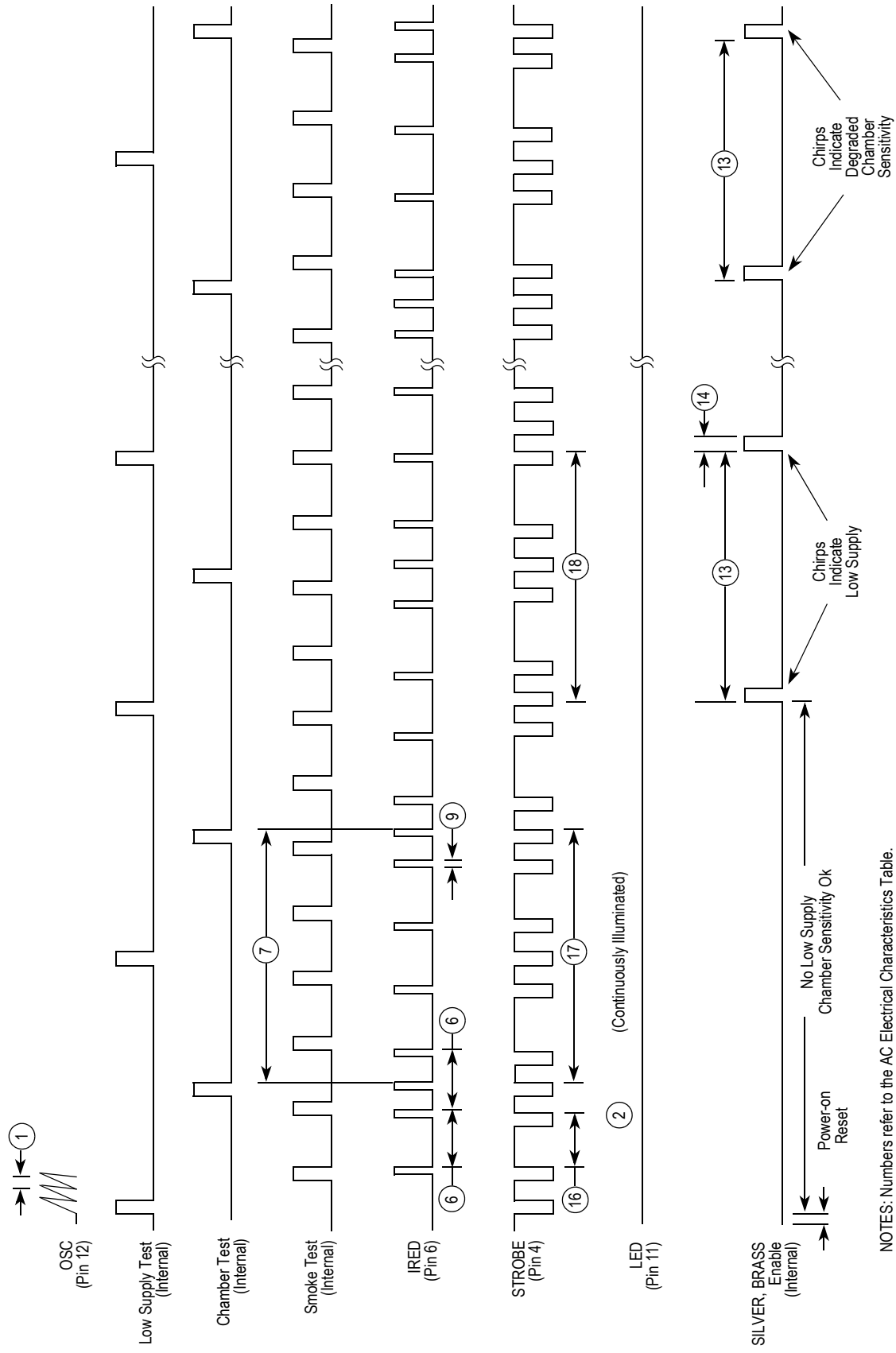

Figure 6. Standby Timing Diagram

NOTES: Numbers refer to the AC Electrical Characteristics Table. Illustration is not to scale.

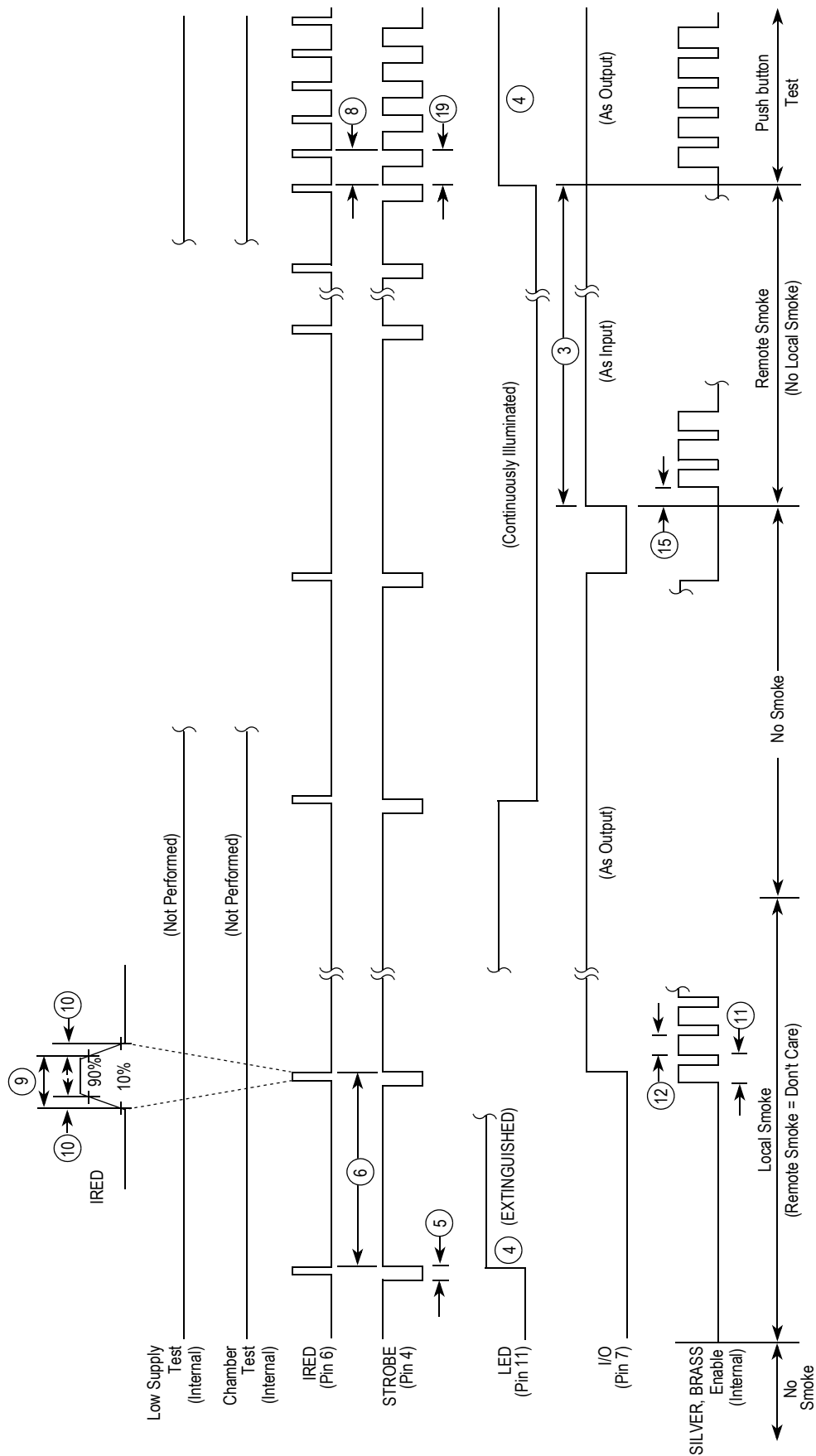
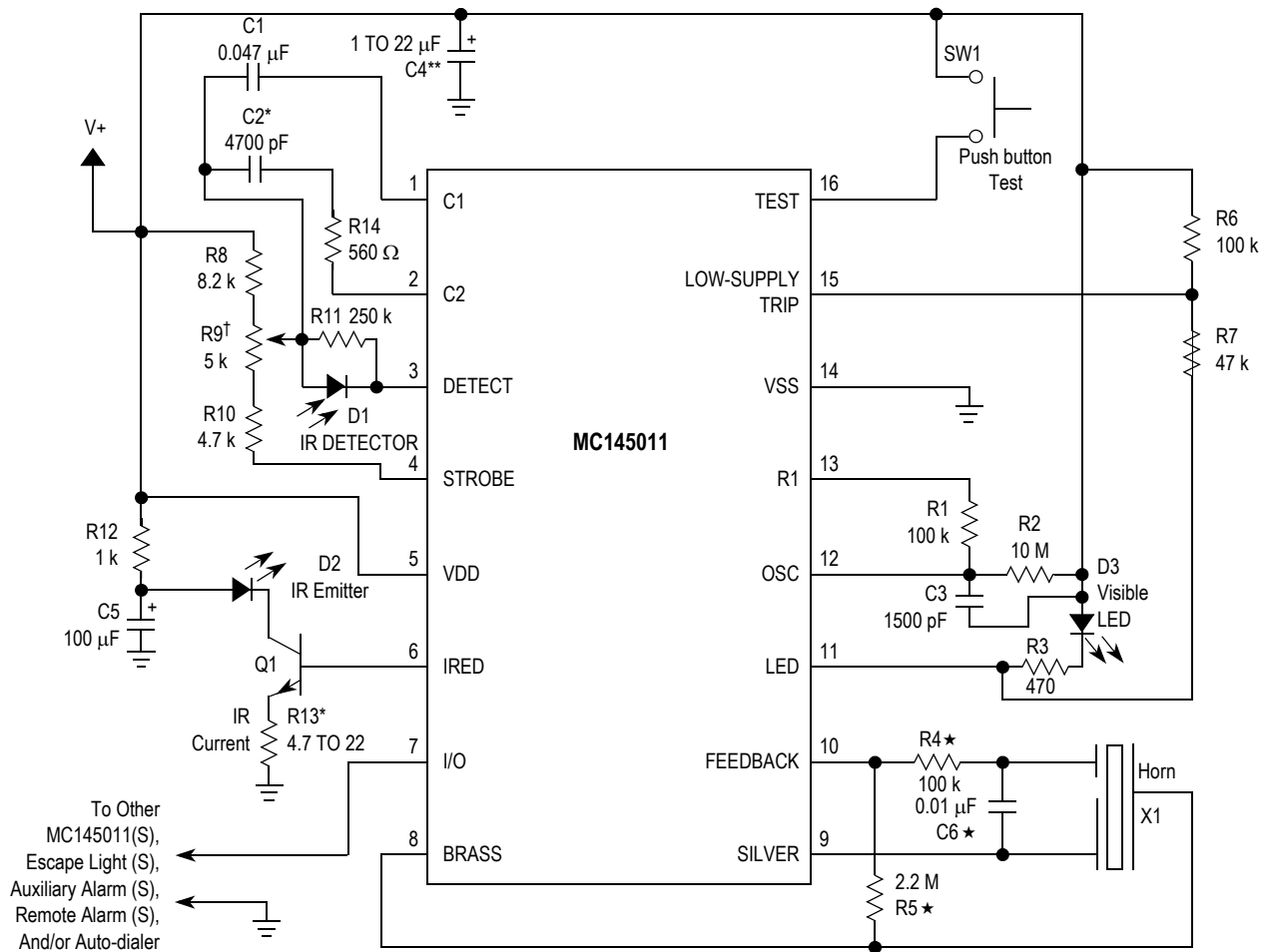

Figure 7. Smoke Timing Diagram

NOTES: Numbers refer to the AC Electrical Characteristics Table.
Illustration is not to scale.



★ Values for R4, R5, and C6 may differ depending on type of piezoelectric horn used.

* C2 and R13 are used for coarse sensitivity adjustment. Typical values are shown.

† R9 is for fine sensitivity adjustment (optional). If fixed resistors are used, R8 = 12 k, R10 is 5.6 k to 10 k, and R9 is eliminated. When R9 is used, noise pickup is increased due to antenna effects. Shielding may be required.

** C4 should be 22 μ F if B1 is a carbon battery. C4 could be reduced to 1 μ F when an alkaline battery is used.

Figure 8. Typical Application

CALIBRATION

To facilitate checking the sensitivity and calibrating smoke detectors, the MC145011 can be placed in a calibration mode. In this mode, certain device pins are controlled/reconfigure as shown in Table 5. To place the part in the calibration mode, Pin 16 (Test) must be pulled below the V_{SS}

pin with 100 μA continuously drawn out of the pin for at least one cycle on the OSC pin. To exit this mode, the Test pin is floated for at least one OSC cycle.

In the calibration mode, the IRED pulse rate is increased to one for every OSC cycle. Also, Strobe is always active low.

Table 5. Configuration of Pins in the Calibration Mode

Pin	Description	Comment
7	I/O	Disabled as an output. Forcing this pin high places the photo amp output on pin 1 or 2, as determined by Low-Supply Trip. The amp's output appears as pulses and is referenced to V_{DD} .
15	LOW-SUPPLY TRIP	If the I/O pin is high, pin 15 controls which gain capacitor is used. Low: normal gain, amp output on pin 1. High: supervisory gain, amp output on pin 2.
10	FEEDBACK	Driving this input high enables hysteresis (10% gain increase) in the photo amp; pin 15 must be low.
12	OSC	Driving this input high brings the internal clock high. Driving the input low brings the internal clock low. If desired, the RC network for the oscillator may be left intact; this allows the oscillator to run similar to the normal mode of operation.
9	SILVER	This pin becomes the smoke comparator output. When the OSC pin is toggling, positive pulses indicate that smoke has been detected. A static low level indicates no smoke.
8	BRASS	This pin becomes the smoke integrator output. That is, 2 consecutive smoke detections are required for "on" (static high level) and 2 consecutive no-detections for "off" (static low level).

Archive Information

Archive Information

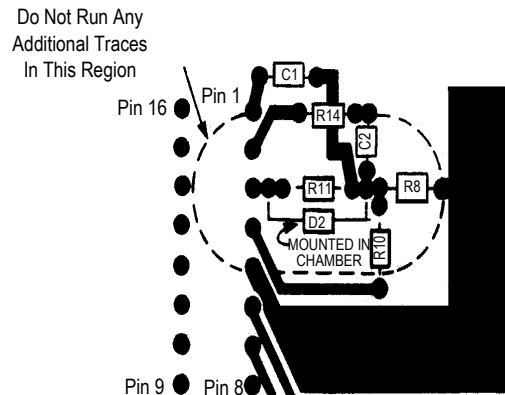

- NOTES: Illustration is bottom view of layout using a DIP. Top view for SOIC layout is mirror image.
 Optional potentiometer R9 is not included.
 Drawing is not to scale.
 Leads on D1, R11, R8, and R10 and their associated traces must be kept as short as possible.
 This practice minimizes noise pick up.
 Pin 3 must be decoupled from all other traces.

Figure 9. Recommended PCB Layout

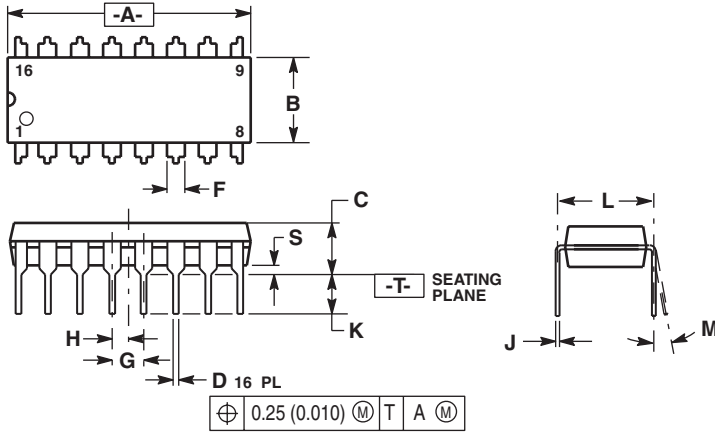
PACKAGE DIMENSIONS

NOTES:

1. DIMENSIONING AND TOLERANCING PER ANSI Y14.5M, 1982.
2. CONTROLLING DIMENSION: INCH.
3. DIMENSION L TO CENTER OF LEADS WHEN FORMED PARALLEL.
4. DIMENSION B DOES NOT INCLUDE MOLD FLASH.
5. ROUNDED CORNERS OPTIONAL.

DIM	INCHES		MILLIMETERS	
	MIN	MAX	MIN	MAX
A	0.740	0.770	18.80	19.55
B	0.250	0.270	6.35	6.85
C	0.145	0.175	3.69	4.44
D	0.015	0.021	0.39	0.53
F	0.040	0.70	1.02	1.77
G	0.100 BSC		2.54 BSC	
H	0.050 BSC		1.27 BSC	
J	0.008	0.015	0.21	0.38
K	0.110	0.130	2.80	3.30
L	0.295	0.305	7.50	7.74
M	0	10	0	10
S	0.020	0.040	0.51	1.01

STYLE 1:

- PIN 1. CATHODE
- CATHODE
- CATHODE
- CATHODE
- CATHODE
- CATHODE
- CATHODE
- CATHODE
- ANODE
- ANODE
- ANODE
- ANODE
- ANODE
- ANODE
- ANODE
- ANODE

STYLE 2:

- PIN 1. COMMON DRAIN
- COMMON DRAIN
- COMMON DRAIN
- COMMON DRAIN
- COMMON DRAIN
- COMMON DRAIN
- COMMON DRAIN
- COMMON DRAIN
- GATE
- SOURCE
- GATE
- SOURCE
- GATE
- SOURCE
- GATE
- SOURCE

**CASE 648-08
ISSUE R
16-LEAD PLASTIC DIP**

Archive Information

Archive Information

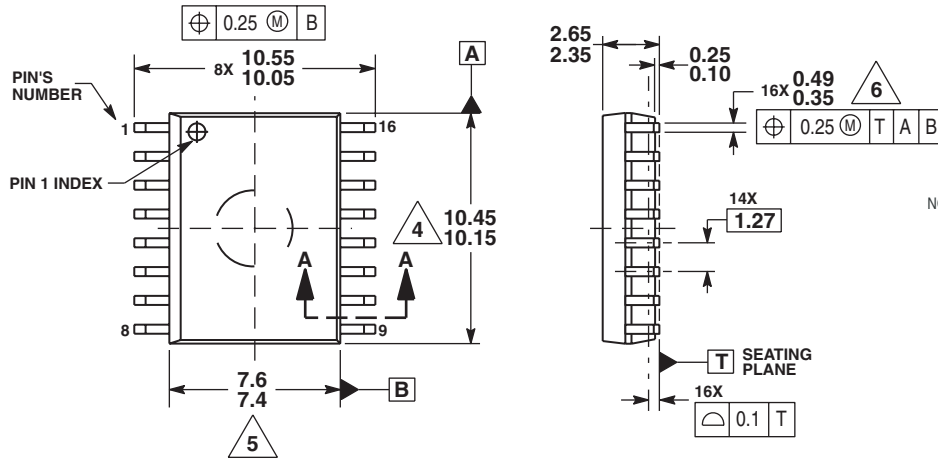

NOTES:

1. DIMENSIONS ARE IN MILLIMETERS.
2. DIMENSIONING AND TOLERANCING PER ASME Y14.5M, 1994.
3. DATUMS A AND B TO BE DETERMINED AT THE PLANE WHERE THE BOTTOM OF THE LEADS EXIT THE PLASTIC BODY.
4. THIS DIMENSION DOES NOT INCLUDE MOLD FLASH, PROTRUSION OR GATE BURRS. MOLD FLASH, PROTRUSION OR GATE BURRS SHALL NOT EXCEED 0.15mm PER SIDE. THIS DIMENSION IS DETERMINED AT THE PLANE WHERE THE BOTTOM OF THE LEADS EXIT THE PLASTIC BODY.
5. THIS DIMENSION DOES NOT INCLUDE INTER-LEAD FLASH OR PROTRUSIONS. INTER-LEAD FLASH AND PROTRUSIONS SHALL NOT EXCEED 0.25mm PER SIDE. THIS DIMENSION IS DETERMINED AT THE PLANE WHERE THE BOTTOM OF THE LEADS EXIT THE PLASTIC BODY.
6. THIS DIMENSION DOES NOT INCLUDE DAMBAR PROTRUSION. ALLOWABLE DAMBAR PROTRUSION SHALL NOT CAUSE THE LEAD WIDTH TO EXCEED 0.62mm.

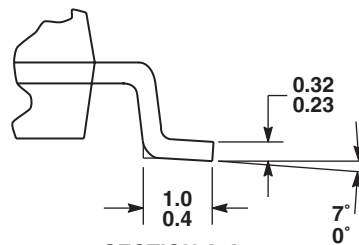
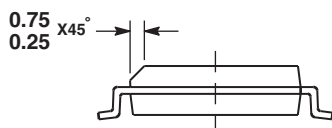
**SECTION A-A
CASE 751G-04
ISSUE D
16-LEAD SOIC**

How to Reach Us:

Home Page:
www.freescale.com

E-mail:
support@freescale.com

USA/Europe or Locations Not Listed:
Freescale Semiconductor
Technical Information Center, CH370
1300 N. Alma School Road
Chandler, Arizona 85224
+1-800-521-6274 or +1-480-768-2130
support@freescale.com

Europe, Middle East, and Africa:
Freescale Halbleiter Deutschland GmbH
Technical Information Center
Schatzbogen 7
81829 Muenchen, Germany
+44 1296 380 456 (English)
+46 8 52200080 (English)
+49 89 92103 559 (German)
+33 1 69 35 48 48 (French)
support@freescale.com

Japan:
Freescale Semiconductor Japan Ltd.
Headquarters
ARCO Tower 15F
1-8-1, Shimo-Meguro, Meguro-ku,
Tokyo 153-0064
Japan
0120 191014 or +81 3 5437 9125
support.japan@freescale.com

Asia/Pacific:
Freescale Semiconductor Hong Kong Ltd.
Technical Information Center
2 Dai King Street
Tai Po Industrial Estate
Tai Po, N.T., Hong Kong
+800 2666 8080
support.asia@freescale.com

For Literature Requests Only:
Freescale Semiconductor Literature Distribution Center
P.O. Box 5405
Denver, Colorado 80217
1-800-441-2447 or 303-675-2140
Fax: 303-675-2150
LDCForFreescaleSemiconductor@hibbertgroup.com

RoHS-compliant and/or Pb-free versions of Freescale products have the functionality and electrical characteristics of their non-RoHS-compliant and/or non-Pb-free counterparts. For further information, see <http://www.freescale.com> or contact your Freescale sales representative.

For information on Freescale's Environmental Products program, go to <http://www.freescale.com/epp>.

Information in this document is provided solely to enable system and software implementers to use Freescale Semiconductor products. There are no express or implied copyright licenses granted hereunder to design or fabricate any integrated circuits or integrated circuits based on the information in this document.

Freescale Semiconductor reserves the right to make changes without further notice to any products herein. Freescale Semiconductor makes no warranty, representation or guarantee regarding the suitability of its products for any particular purpose, nor does Freescale Semiconductor assume any liability arising out of the application or use of any product or circuit, and specifically disclaims any and all liability, including without limitation consequential or incidental damages. "Typical" parameters that may be provided in Freescale Semiconductor data sheets and/or specifications can and do vary in different applications and actual performance may vary over time. All operating parameters, including "Typicals", must be validated for each customer application by customer's technical experts. Freescale Semiconductor does not convey any license under its patent rights nor the rights of others. Freescale Semiconductor products are not designed, intended, or authorized for use as components in systems intended for surgical implant into the body, or other applications intended to support or sustain life, or for any other application in which the failure of the Freescale Semiconductor product could create a situation where personal injury or death may occur. Should Buyer purchase or use Freescale Semiconductor products for any such unintended or unauthorized application, Buyer shall indemnify and hold Freescale Semiconductor and its officers, employees, subsidiaries, affiliates, and distributors harmless against all claims, costs, damages, and expenses, and reasonable attorney fees arising out of, directly or indirectly, any claim of personal injury or death associated with such unintended or unauthorized use, even if such claim alleges that Freescale Semiconductor was negligent regarding the design or manufacture of the part.

Freescale™ and the Freescale logo are trademarks of Freescale Semiconductor, Inc. All other product or service names are the property of their respective owners.

© Freescale Semiconductor, Inc. 2006. All rights reserved.