

SEVEN DARLINGTON ARRAYS

- SEVEN DARLINGTONS PER PACKAGE
- OUTPUT CURRENT 500 mA PER DRIVER (600 mA PEAK)
- OUTPUT VOLTAGE 50 V
- INTEGRAL SUPPRESSION DIODES FOR INDUCTIVE LOADS
- OUTPUT CAN BE PARRALLELED FOR HIGHER CURRENT
- TTL/CMOS/PMOS/DTL COMPATIBLE INPUTS
- INPUTS PINNED OPPOSITE OUTPUTS TO SIMPLIFY LAYOUT

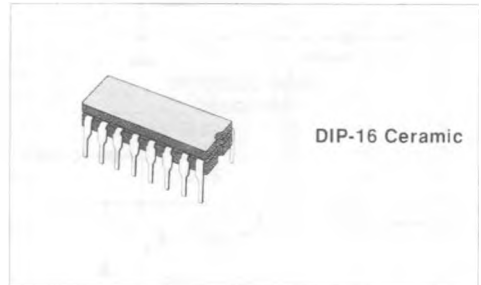

DESCRIPTION

The ULQ2001R, ULQ2002R, ULQ2003R and ULQ2004R are high voltage, high current darlington arrays each containing seven open collector darlington pairs with common emitters. Each channel is rated at 500 mA and can withstand peak currents of 600 mA. Suppression diodes are included for inductive load driving and the inputs are pinned opposite the outputs to simplify board layout.

The four versions interface to all common families.

ULQ2001R	General Purpose, DTL, TTL, CMOS
ULQ2002R	15-25 V PMOS
ULQ2003R	5 V TTL, CMOS
ULQ2004R	6-15 V CMOS, PMOS

These versatile devices are useful for driving a wide range of loads including solenoids, relays DC motors, LED displays, filament lamps, thermal print-heads and high power buffers.

The ULQ2001R, ULQ2002R, ULQ2003R and ULQ2004R are supplied in 16 pin ceramic DIP packages.

PIN CONNECTION

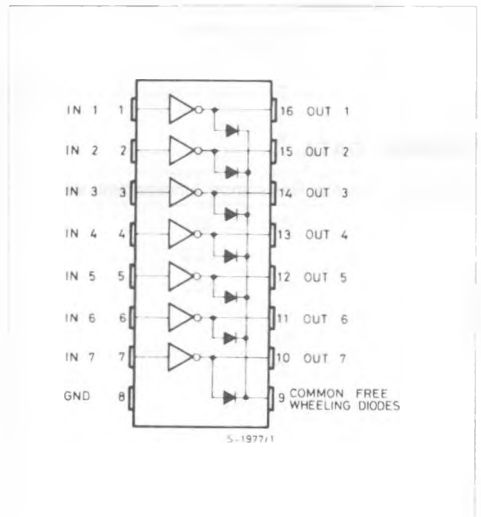

ABSOLUTE MAXIMUM RATINGS

Symbol	Parameter	Value	Unit
V_o	Output Voltage	50	V
V_{in}	Input Voltage (for ULQ2002R/2003R/2004R)	30	V
I_c	Continuous Collector Current	500	mA
I_b	Continuous Base Current	25	mA
T_{amb}	Operating Ambient Temperature Range	- 20 to + 85	C
T_{stg}	Storage Temperature Range	- 55 to 150	C

SCHEMATIC DIAGRAM

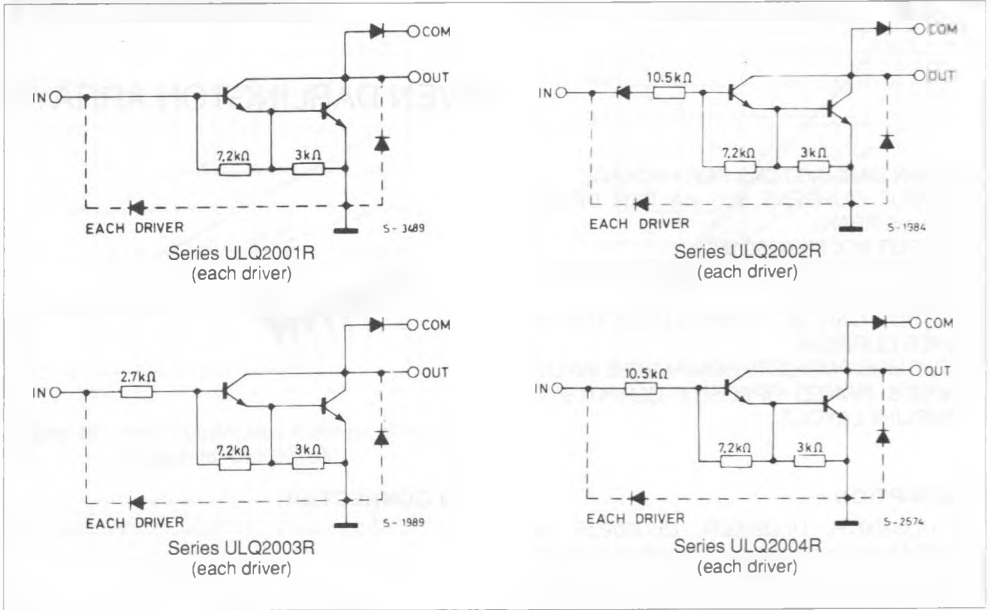

THERMAL DATA

$R_{th\ j-amb}$	Thermal Resistance Junction-ambient	Max	150	°C/W
-----------------	-------------------------------------	-----	-----	------

ELECTRICAL CHARACTERISTICS ($T_{amb} = 25^{\circ} \text{C}$ unless otherwise specified)

Symbol	Parameter	Test Conditions	Min.	Typ.	Max.	Unit	Fig.	
I_{CEX}	Output Leakage Current	$V_{CE} = 50 \text{ V}$			50	μA	1a	
		$T_{amb} = 70^{\circ} \text{C}$ $V_{CE} = 50 \text{ V}$			100	μA	1a	
		$T_{amb} = 70^{\circ} \text{C}$ for ULQ2002R						
		$V_{CE} = 50 \text{ V}$ $V_i = 6 \text{ V}$ for ULQ2004R				500	μA	1b
		$V_{CE} = 50 \text{ V}$ $V_i = 1 \text{ V}$			500	μA	1b	
$V_{CE(sat)}$	Collector-emitter Saturation Voltage	$I_C = 100 \text{ mA}$ $I_B = 250 \mu\text{A}$		0.9	1.1	V	2	
		$I_C = 200 \text{ mA}$ $I_B = 350 \mu\text{A}$		1.1	1.3	V	2	
		$I_C = 350 \text{ mA}$ $I_B = 500 \mu\text{A}$		1.3	1.6	V	2	
$I_{i(on)}$	Input Current	for ULQ2002R $V_i = 17 \text{ V}$		0.82	1.25	mA	3	
		for ULQ2003R $V_i = 3.85 \text{ V}$		0.93	1.35	mA	3	
		for ULQ2004R $V_i = 5 \text{ V}$		0.35	0.5	mA	3	
		$V_i = 12 \text{ V}$		1	1.45	mA	3	
$I_{i(off)}$	Input Current	$T_{amb} = 70^{\circ} \text{C}$ $I_C = 500 \mu\text{A}$	50	65		μA	4	
$V_{i(on)}$	Input Voltage	for ULQ2002R $V_{CE} = 2 \text{ V}$ $I_C = 300 \text{ mA}$			13	V	5	
		for ULQ2003R $V_{CE} = 2 \text{ V}$ $I_C = 200 \text{ mA}$			2.4	V	5	
		$V_{CE} = 2 \text{ V}$ $I_C = 250 \text{ mA}$			2.7	V	5	
		$V_{CE} = 2 \text{ V}$ $I_C = 300 \text{ mA}$			3	V	5	
		for ULQ2004R $V_{CE} = 2 \text{ V}$ $I_C = 125 \text{ mA}$			5	V	5	
		$V_{CE} = 2 \text{ V}$ $I_C = 200 \text{ mA}$			6	V	5	
		$V_{CE} = 2 \text{ V}$ $I_C = 275 \text{ mA}$			7	V	5	
		$V_{CE} = 2 \text{ V}$ $I_C = 350 \text{ mA}$			8	V	5	
h_{FE}	DC Forward Current Gain	for ULQ2001R $V_{CE} = 2 \text{ V}$ $I_C = 350 \text{ mA}$	1000			-	2	
C_i	Input Capacitance			15	25	pF	-	
t_{PLH}	Turn-on Delay Time	$0.5 V_i$ to $0.5 V_o$		0.25	1	μs	-	
t_{PHL}	Turn-off Delay Time	$0.5 V_i$ to $0.5 V_o$		0.25	1	μs	-	
I_R	Clamp Diode Leakage Current	$V_R = 50 \text{ V}$			50	μA	6	
		$T_{amb} = 70^{\circ} \text{C}$ $V_R = 50 \text{ V}$			100	μA	6	
V_F	Clamp Diode Forward Voltage	$I_F = 350 \text{ mA}$		1.7	2	V	7	

TEST CIRCUITS

Figure 1a.

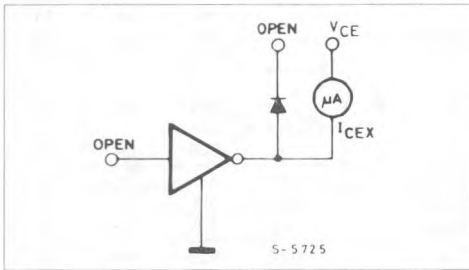

Figure 1b.

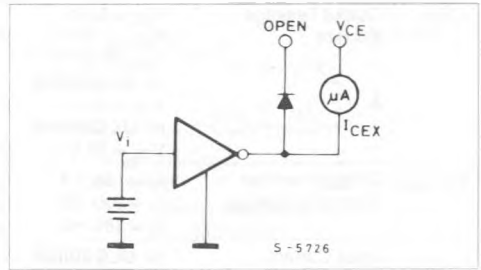

Figure 2.

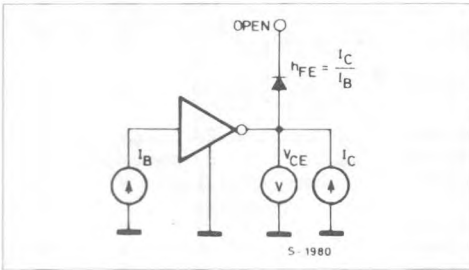

Figure 3.

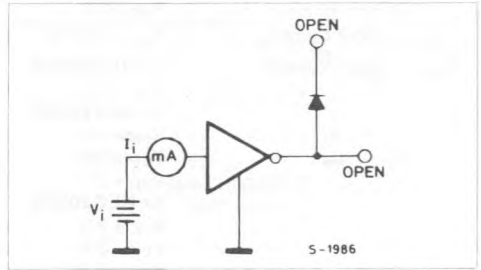

Figure 4.

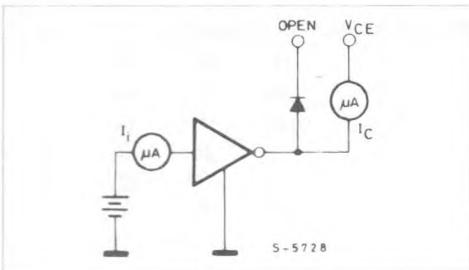

Figure 5.

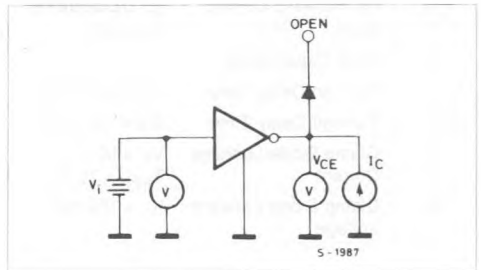

Figure 6.

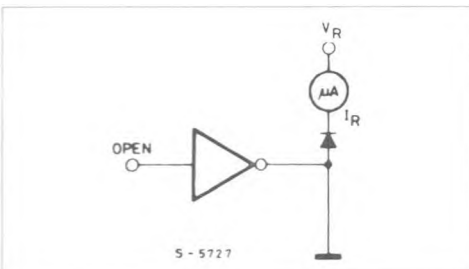

Figure 7.

