

# International IOR Rectifier

## 10WQ045FN

### SCHOTTKY RECTIFIER

10 Amp



#### Major Ratings and Characteristics

Characteristics	10WQ045FN	Units
$I_{F(AV)}$ Rectangular waveform	10	A
$V_{RRM}$	45	V
$I_{FSM}$ @ $t_p=5 \mu s$ sine	400	A
$V_F$ @ $10A_{pk}, T_J=125^\circ C$	0.53	V
$T_J$ range	-40 to 175	$^\circ C$

#### Description/ Features

The 10WQ045FN surface mount Schottky rectifier has been designed for applications requiring low forward drop and small foot prints on PC board. Typical applications are in disk drives, switching power supplies, converters, free-wheeling diodes, battery charging, and reverse battery protection.

- Popular D-PAK outline
- Small foot print, surface mountable
- Low forward voltage drop
- High frequency operation
- Guard ring for enhanced ruggedness and long term reliability

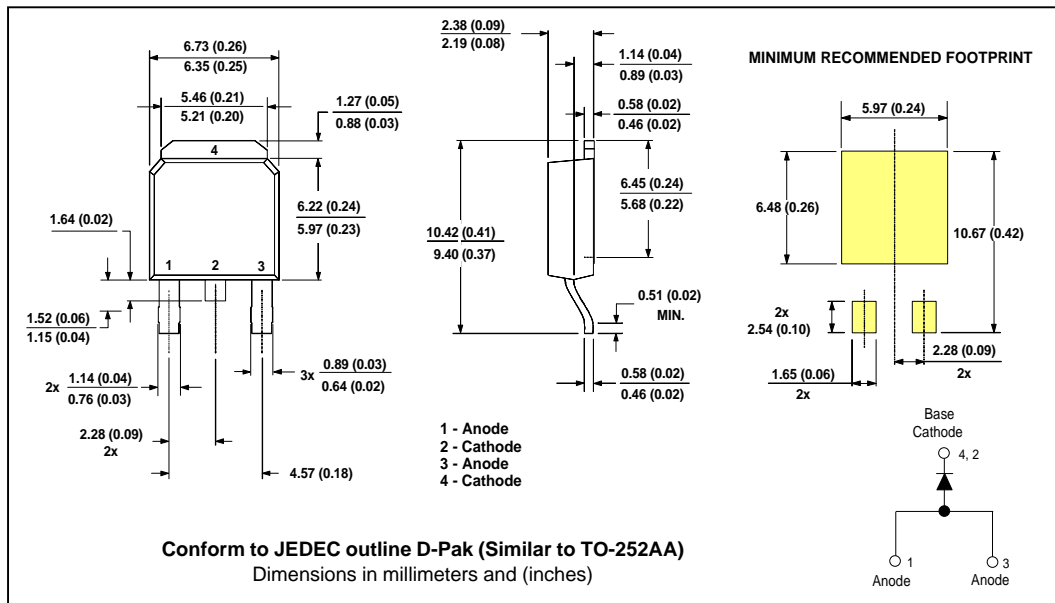

## Voltage Ratings

Part number	10WQ045FN
$V_R$ Max. DC Reverse Voltage (V)	45
$V_{RWM}$ Max. Working Peak Reverse Voltage (V)	

## Absolute Maximum Ratings

Parameters	10WQ...	Units	Conditions
$I_{F(AV)}$ Max. Average Forward Current * See Fig. 5	10	A	50% duty cycle @ $T_C = 157^\circ\text{C}$ , rectangular wave form
$I_{FSM}$ Max. Peak One Cycle Non-Repet. Surge Current * See Fig. 7	400	A	5 $\mu\text{s}$ Sine or 3 $\mu\text{s}$ Rect. pulse
	75		10ms Sine or 6ms Rect. pulse
$E_{AS}$ Non-Repetitive Avalanche Energy	20	mJ	$T_J = 25^\circ\text{C}$ , $I_{AS} = 3.0$ Amps, $L = 4.40$ mH
$I_{AR}$ Repetitive Avalanche Current	3.0	A	Current decaying linearly to zero in 1 $\mu\text{sec}$ Frequency limited by $T_J$ max. $V_A = 1.5 \times V_R$ typical

## Electrical Specifications

Parameters	10WQ...	Units	Conditions
$V_{FM}$ Max. Forward Voltage Drop * See Fig. 1 (1)	0.630	V	@ 10A $T_J = 25^\circ\text{C}$
	0.800	V	@ 20A $T_J = 25^\circ\text{C}$
	0.530	V	@ 10A $T_J = 125^\circ\text{C}$
	0.710	V	@ 20A $T_J = 125^\circ\text{C}$
$I_{RM}$ Max. Reverse Leakage Current * See Fig. 2 (1)	1	mA	$T_J = 25^\circ\text{C}$ $V_R = \text{rated } V_R$
	15	mA	$T_J = 125^\circ\text{C}$ $V_R = \text{rated } V_R$
$V_{F(TO)}$ Threshold Voltage	0.255	V	$T_J = T_J \text{ max.}$
$r_t$ Forward Slope Resistance	22	m $\Omega$	
$C_T$ Typical Junction Capacitance	760	pF	$V_R = 5V_{DC}$ (test signal range 100Khz to 1Mhz) $25^\circ\text{C}$
$L_S$ Typical Series Inductance	5.0	nH	Measured lead to lead 5mm from package body

(1) Pulse Width < 300 $\mu\text{s}$ , Duty Cycle < 2%

## Thermal-Mechanical Specifications

Parameters	10WQ...	Units	Conditions
$T_J$ Max. Junction Temp. Range(*)	- 40 to 175	$^\circ\text{C}$	
$T_{stg}$ Max. Storage Temperature Range	- 40 to 175	$^\circ\text{C}$	
$R_{thJC}$ Max. Thermal Resistance Junction to Case	2.0	$^\circ\text{C}/\text{W}$	DC operation * See Fig. 4
$R_{thJA}$ Max. Thermal Resistance Junction to Ambient	50	$^\circ\text{C}/\text{W}$	
wt Approximate Weight	0.3(0.01)	g(oz.)	
Case Style	D - PAK		Similar to TO-252AA

(\*)  $\frac{dP_{tot}}{dT_J} < \frac{1}{R_{th(j-a)}}$  thermal runaway condition for a diode on its own heatsink

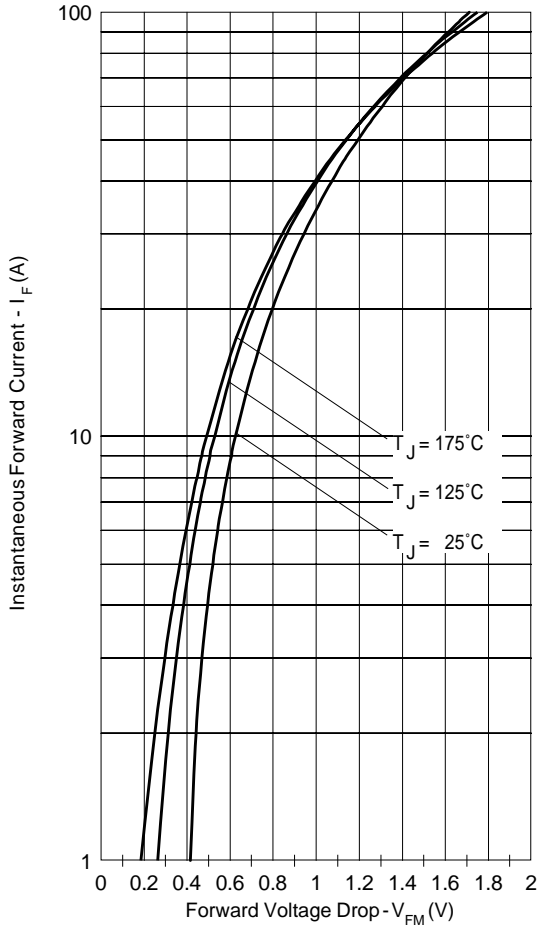

Fig. 1 - Maximum Forward Voltage Drop Characteristics

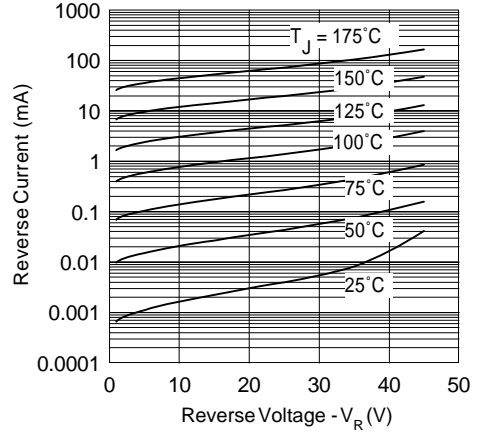

Fig. 2 - Typical Values of Reverse Current Vs. Reverse Voltage

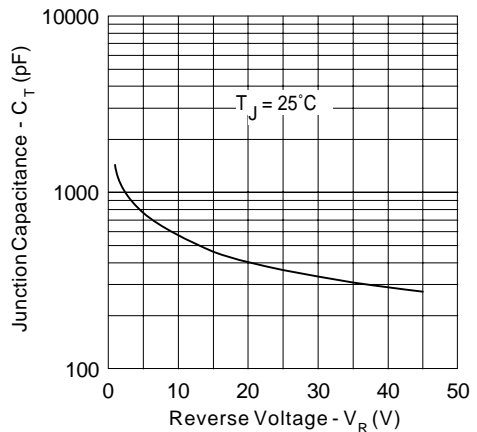

Fig. 3 - Typical Junction Capacitance Vs. Reverse Voltage

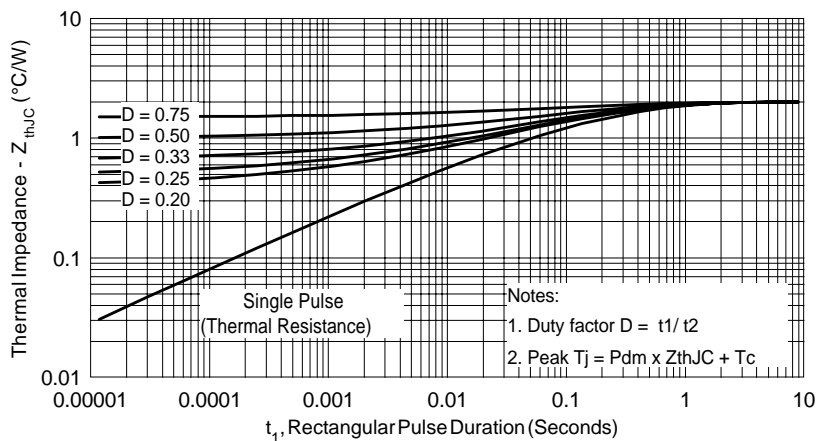

Fig. 4 - Maximum Thermal Impedance  $Z_{thJC}$  Characteristics

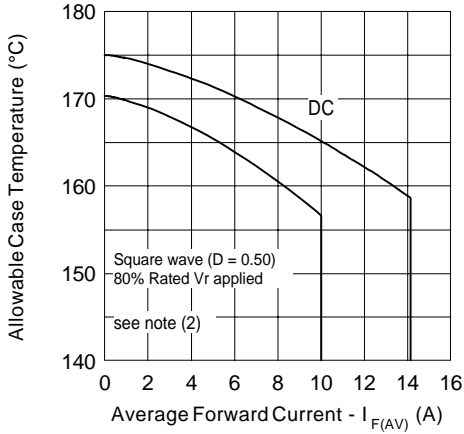

Fig. 5 - Maximum Allowable Case Temperature Vs. Average Forward Current

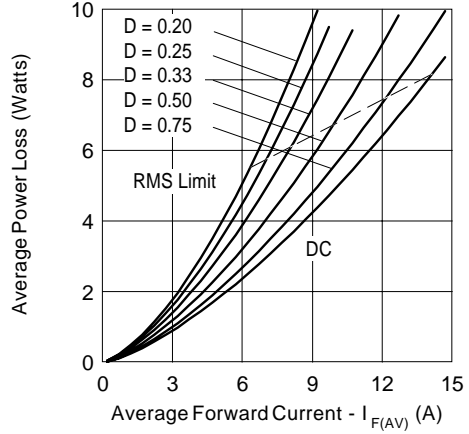

Fig. 6 - Forward Power Loss Characteristics

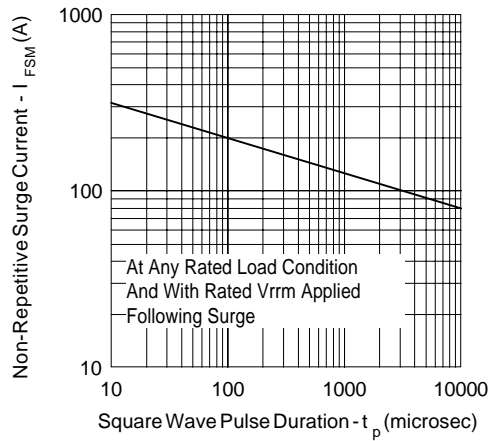
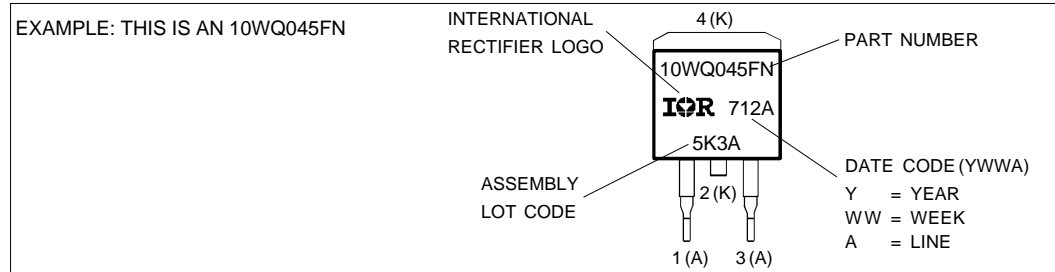

Fig. 7 - Maximum Non-Repetitive Surge Current

- (2) Formula used:  $T_c = T_j - (Pd + Pd_{REV}) \times R_{thJC}$ ;  
 $Pd = \text{Forward Power Loss} = I_{F(AV)} \times V_{FM} @ (I_{F(AV)}/D)$  (see Fig. 6);  
 $Pd_{REV} = \text{Inverse Power Loss} = V_{R1} \times I_R (1 - D)$ ;  $I_R @ V_{R1} = 80\% \text{ rated } V_R$

Marking Information



Tape & Reel Information

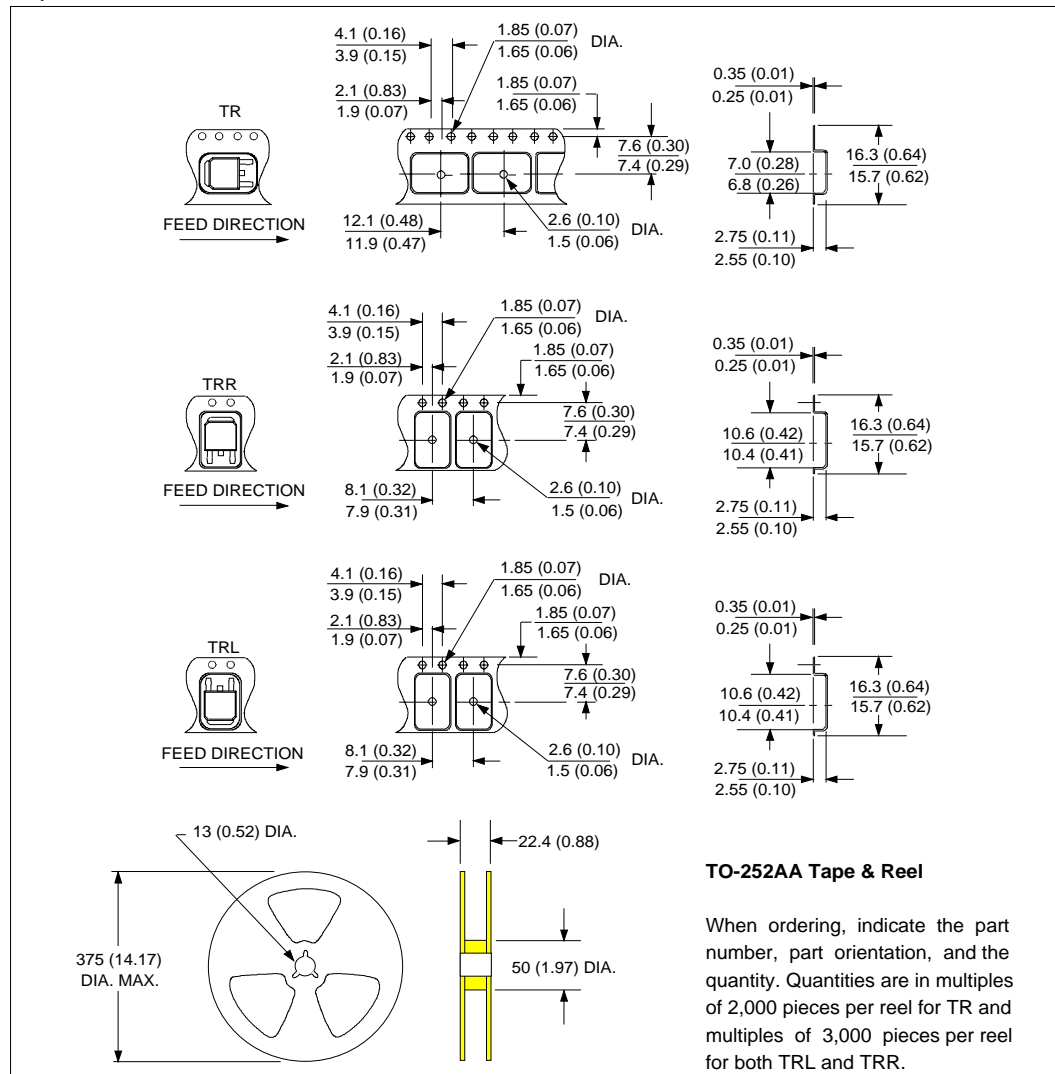

10WQ045FN

Bulletin PD-20530 rev. F 03/03

International  
**IOR** Rectifier

---

Data and specifications subject to change without notice.  
This product has been designed and qualified for Industrial Level.  
Qualification Standards can be found on IR's Web site.

International  
**IOR** Rectifier

**IR WORLD HEADQUARTERS:** 233 Kansas St., El Segundo, California 90245, USA Tel: (310) 252-7105  
TAC Fax: (310) 252-7309  
Visit us at [www.irf.com](http://www.irf.com) for sales contact information. 03/03