



15ETH03
15ETH03S
15ETH03-1

Ultrafast Rectifier

Features

- Ultrafast Recovery Time
- Low Forward Voltage Drop
- Low Leakage Current
- 175°C Operating Junction Temperature

$t_{rr} = 40ns$
$I_{F(AV)} = 15Amp$
$V_R = 300V$

Description/ Applications

International Rectifier's 300V series are the state of the art Ultrafast recovery rectifiers designed with optimized performance of forward voltage drop and Ultrafast recovery time.

The planar structure and the platinum doped life time control guarantee the best overall performance, ruggedness and reliability characteristics.

These devices are intended for use in the output rectification stage of SMPS, UPS, DC-DC converters as well as freewheeling diodes in low voltage inverters and chopper motor drives.

Their extremely optimized stored charge and low recovery current minimize the switching losses and reduce over dissipation in the switching element and snubbers.

Absolute Maximum Ratings

Parameters	Max	Units
V_{RRM} Repetitive Peak Reverse Voltage	300	V
$I_{F(AV)}$ Average Rectified Forward Current @ $T_C = 142^\circ C$	15	A
I_{FSM} Non Repetitive Peak Surge Current @ $T_J = 25^\circ C$	140	
T_J, T_{STG} Operating Junction and Storage Temperatures	- 65 to 175	$^\circ C$

Case Styles		
<p>15ETH03</p>  <p>TO-220AC</p>	<p>15ETH03S</p>  <p>D²PAK</p>	<p>15ETH03-1</p>  <p>TO-262</p>

Electrical Characteristics @ T_J = 25°C (unless otherwise specified)

Parameters	Min	Typ	Max	Units	Test Conditions
V _{BR} , V _F Breakdown Voltage, Blocking Voltage	300	-	-	V	I _R = 100μA
V _F Forward Voltage	-	1.05	1.25	V	I _F = 15A, T _J = 25°C
	-	0.85	1.00	V	I _F = 15A, T _J = 125°C
I _R Reverse Leakage Current	-	0.05	40	μA	V _R = V _R Rated
	-	12	400	μA	T _J = 125°C, V _R = V _R Rated
C _T Junction Capacitance	-	45	-	pF	V _R = 300V
L _S Series Inductance	-	8	-	nH	Measured lead to lead 5mm from package body

Dynamic Recovery Characteristics @ T_J = 25°C (unless otherwise specified)

Parameters	Min	Typ	Max	Units	Test Conditions
t _{rr} Reverse Recovery Time	-	-	40	ns	I _F = 1.0A, di _F /dt = 50A/μs, V _R = 30V
	-	32	-		T _J = 25°C
	-	45	-		T _J = 125°C
I _{RRM} Peak Recovery Current	-	2.4	-	A	T _J = 25°C
	-	6.1	-		T _J = 125°C
Q _{rr} Reverse Recovery Charge	-	38	-	nC	T _J = 25°C
	-	137	-		T _J = 125°C

I_F = 15A
di_F/dt = -200A/μs
V_R = 200V

Thermal - Mechanical Characteristics

Parameters	Min	Typ	Max	Units
T _J Max. Junction Temperature Range	- 65	-	175	°C
T _{Stg} Max. Storage Temperature Range	- 65	-	175	
R _{thJC} Thermal Resistance, Junction to Case Per Leg	-	1.02	2.0	°C/W
R _{thJA} ^① Thermal Resistance, Junction to Ambient Per Leg	-	-	70	
R _{thCS} ^② Thermal Resistance, Case to Heatsink	-	0.2	-	
Wt Weight	-	2.0	-	g
	-	0.07	-	(oz)
Mounting Torque	6.0	-	12	Kg-cm
	5.0	-	10	lbf.in

① Typical Socket Mount

② Mounting Surface, Flat, Smooth and Greased

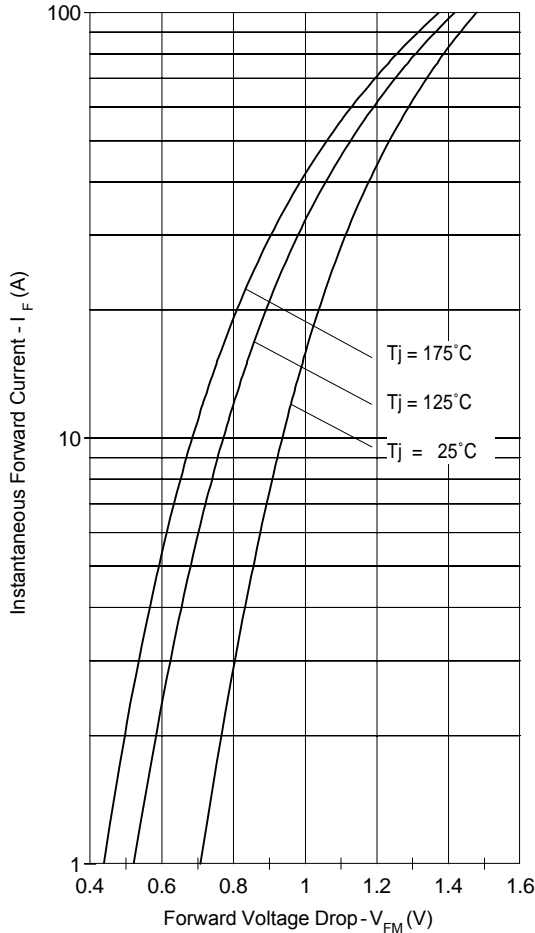

Fig. 1 - Typical Forward Voltage Drop Characteristics

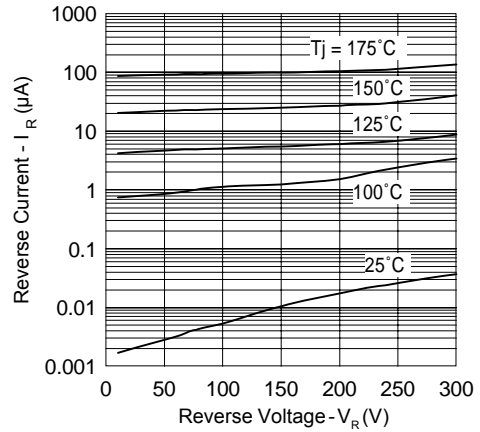

Fig. 2 - Typical Values Of Reverse Current Vs. Reverse Voltage

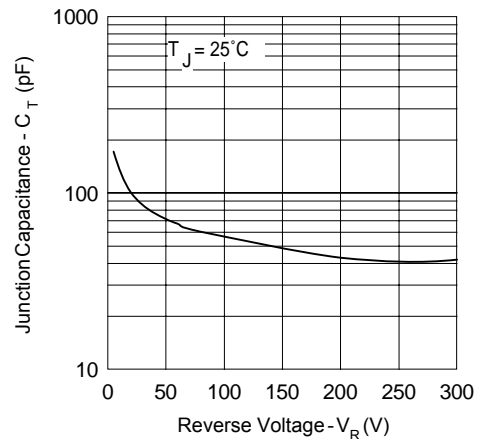

Fig. 3 - Typical Junction Capacitance Vs. Reverse Voltage

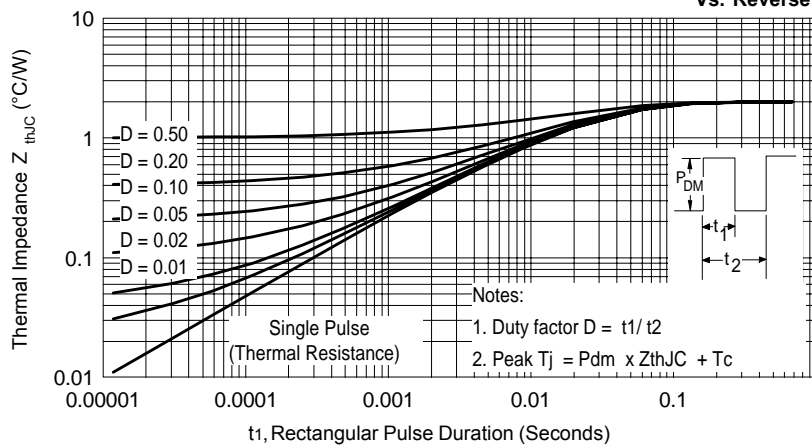

Fig. 4 - Max. Thermal Impedance Z_{thJC} Characteristics

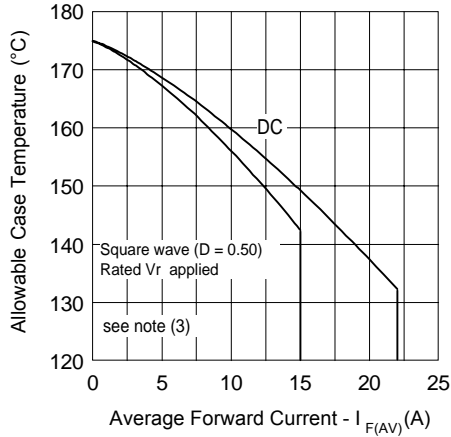

Fig. 5 - Max. Allowable Case Temperature Vs. Average Forward Current

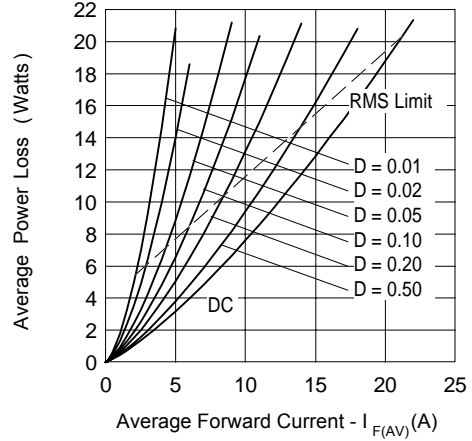

Fig. 6 - Forward Power Loss Characteristics

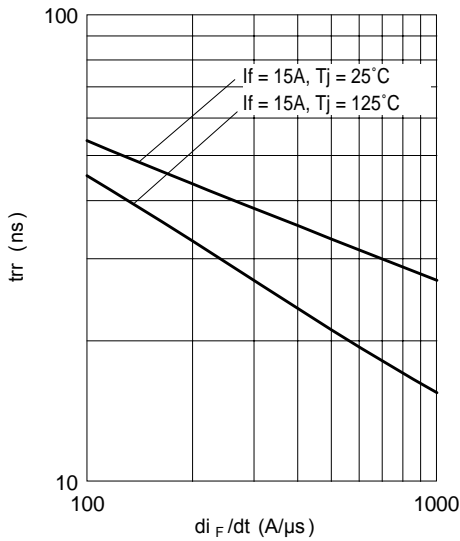

Fig. 7 - Typical Reverse Recovery vs. di_F/dt

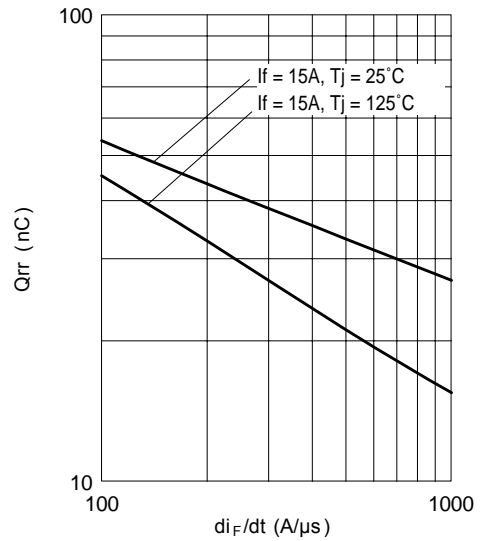

Fig. 8 - Typical Stored Charge vs. di_F/dt

(3) Formula used: $T_C = T_J - (Pd + Pd_{REV}) \times R_{thJC}$;

Pd = Forward Power Loss = $I_{F(AV)} \times V_{FM} @ (I_{F(AV)} / D)$ (see Fig. 6);

Pd_{REV} = Inverse Power Loss = $V_{R1} \times I_R (1 - D)$; $I_R @ V_{R1}$ = rated V_R

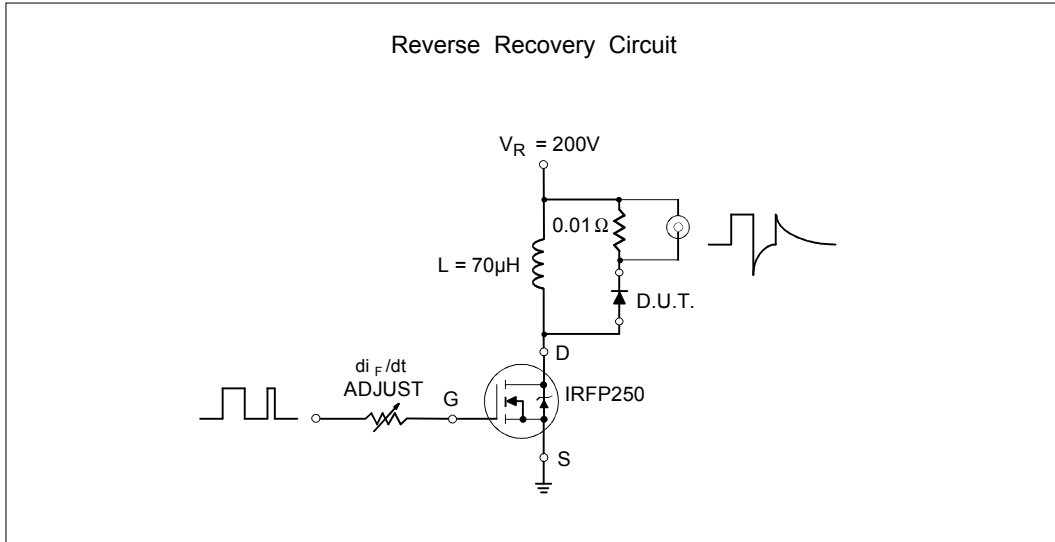

Fig. 9 - Reverse Recovery Parameter Test Circuit

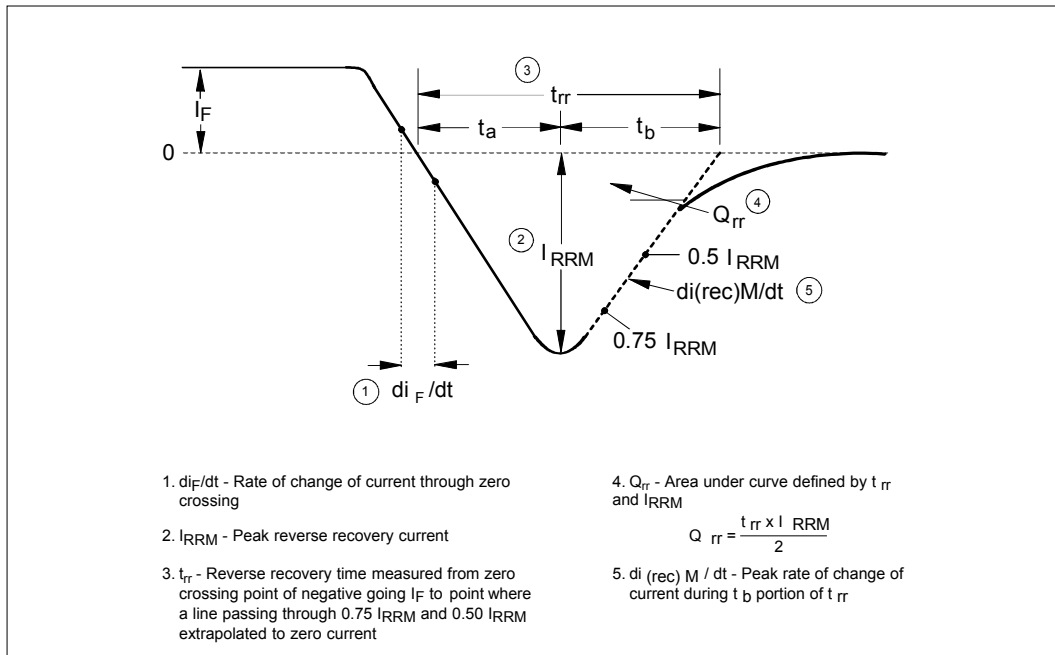
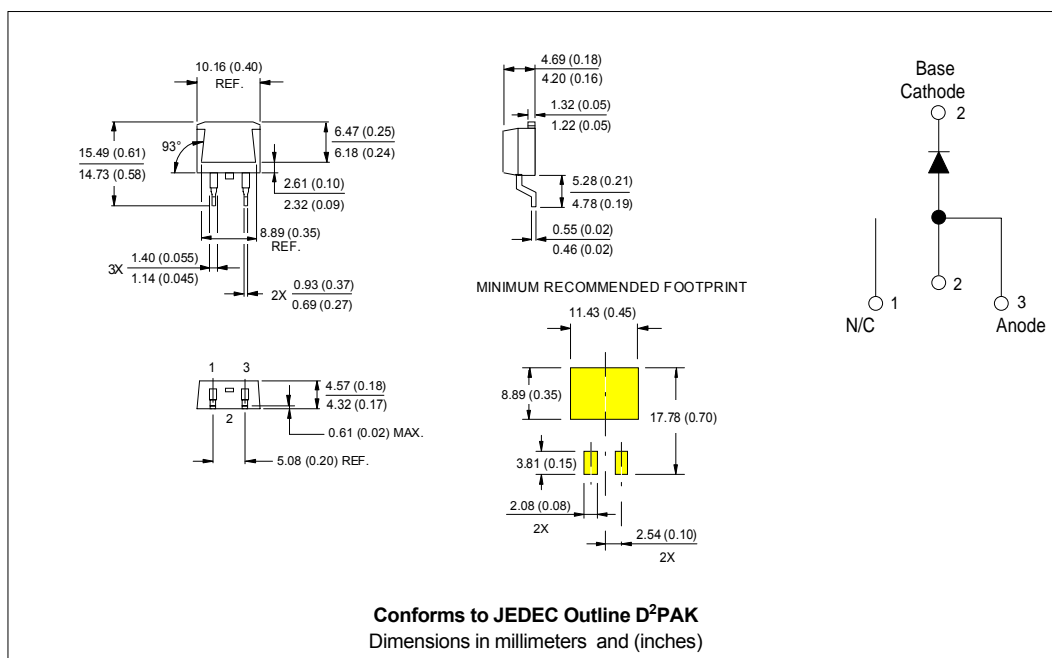
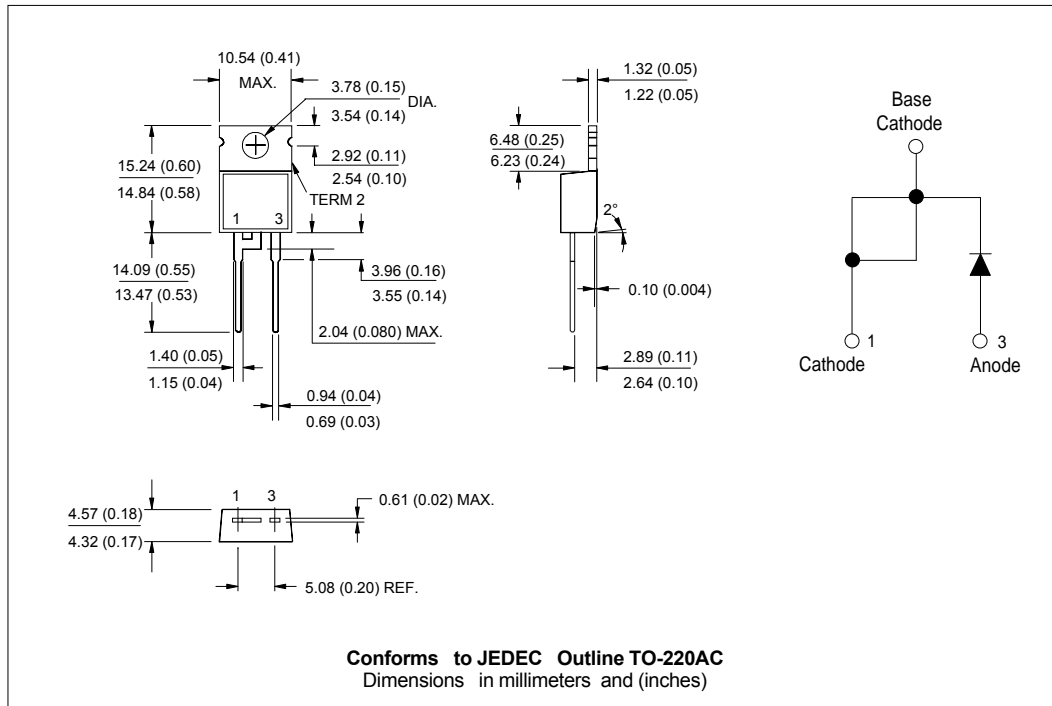
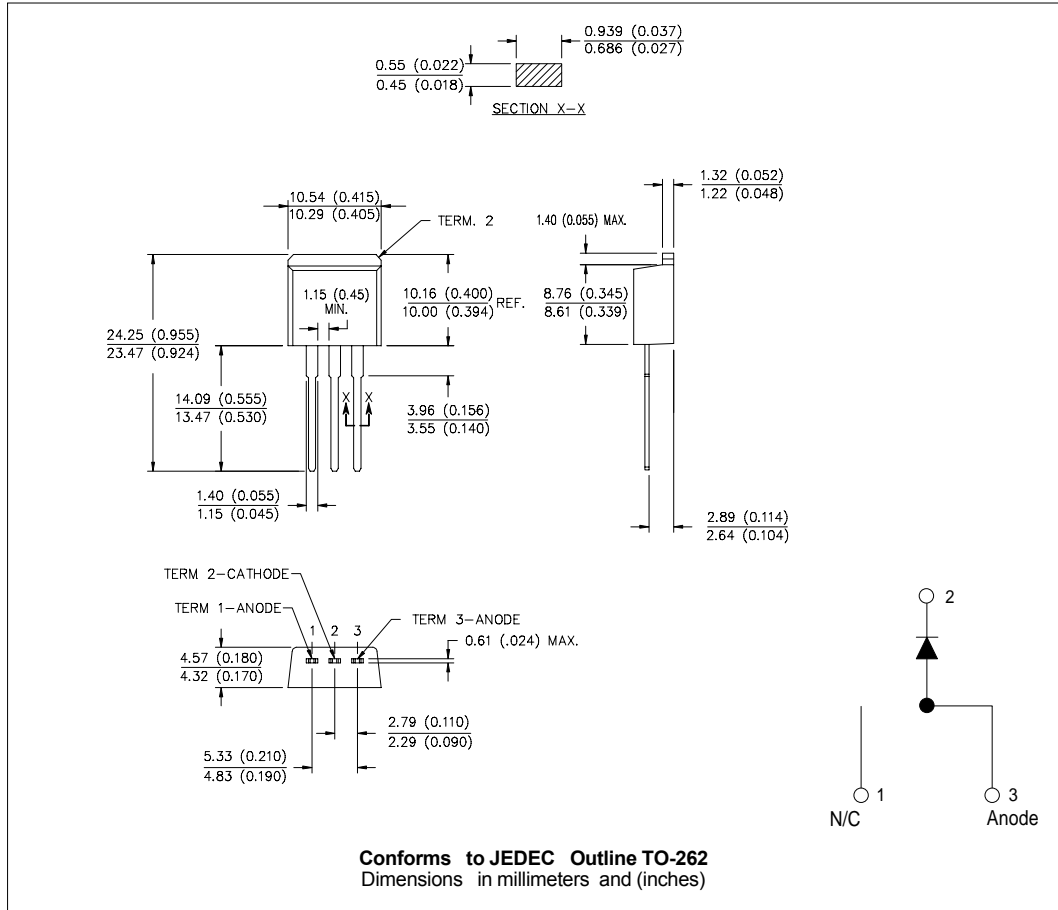

Fig. 10 - Reverse Recovery Waveform and Definitions

Outline Table



Outline Table



Marking Information

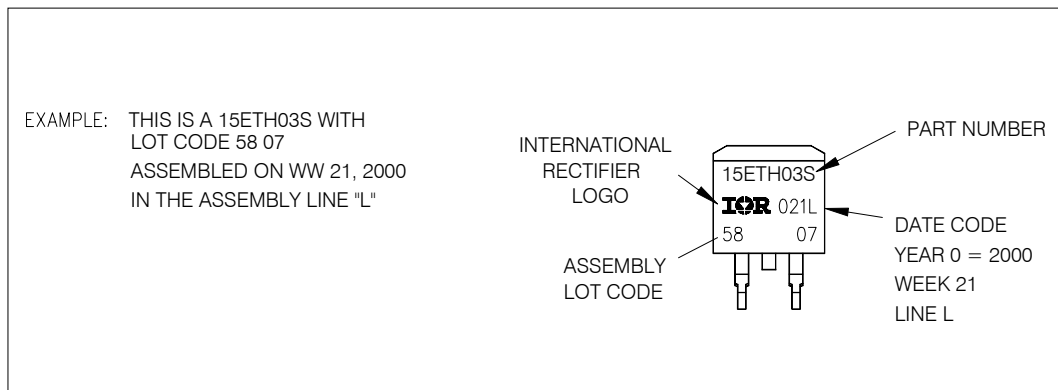

15ETH03, 15ETH03S, 15ETH03-1

Bulletin PD-20031 rev. B 04/01

International
IOR Rectifier

Data and specifications subject to change without notice.
This product has been designed and qualified for Industrial Level.
Qualification Standards can be found on IR's Web site.

International
IOR Rectifier

IR WORLD HEADQUARTERS: 233 Kansas St., El Segundo, California 90245, USA Tel: (310) 252-7105
TAC Fax: (310) 252-7309
Visit us at www.irf.com for sales contact information. 04/01