

High-Speed Switching Ultra Mini Diode

1SS254

●Applications

High speed switching

●Features

- 1) Glass sealed envelope (USD)
- 2) Small pitch enables insertion on PCBs
- 3) High reliability
- 4) High speed ($t_{rr}=1.5\text{ns Typ.}$)

●Construction

Silicon epitaxial planar

●External dimensions (Units: mm)

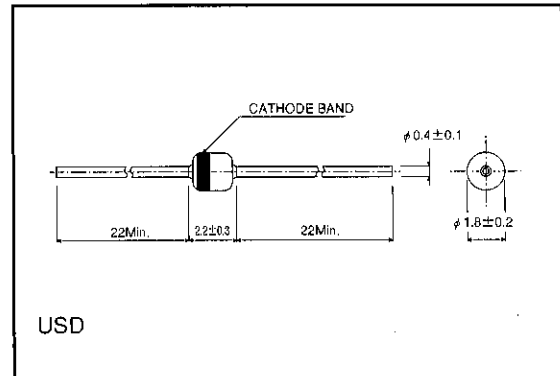

●Absolute maximum ratings ($T_a=25^\circ\text{C}$)

Parameter	Symbol	Limits	Unit
Peak reverse voltage	V_{RM}	90	V
DC reverse voltage	V_R	80	V
Peak forward current	I_{FM}	400	mA
Mean rectifying current	I_o	130	mA
Surge current (1s)	I_{surge}	600	mA
Power dissipation	P	250	mW
Junction temperature	T_j	175	$^\circ\text{C}$
Storage temperature	T_{stg}	$-65 \sim 175$	$^\circ\text{C}$

●Cathode band colors

Type	Color
1SS254	Yellow

●Electrical characteristics (Ta=25°C)

Parameter	Symbol	Min.	Typ.	Max.	Unit	Conditions
Forward voltage	V_F	—	0.92	1.2	V	$I_F=100\text{mA}$
Reverse current	I_R	—	0.010	0.5	μA	$V_R=35\text{V}$
Capacitance between terminals	C_T	—	1.55	3	pF	$V_R=0.5\text{V}$, $f=1\text{MHz}$
Reverse recovery time	t_{rr}	—	1.5	4	ns	$V_R=6\text{V}$, $I_F=10\text{mA}$, $R_L=50\Omega$

●Electrical characteristic curves (Ta=25°C)

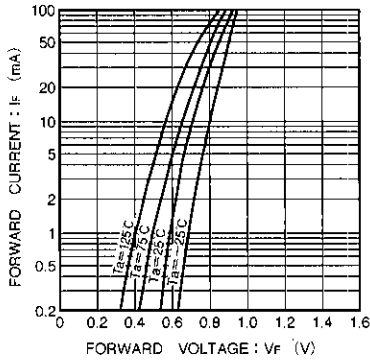

Fig. 1 Forward temperature characteristic

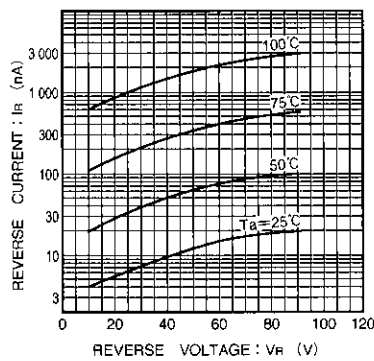

Fig. 2 Reverse temperature characteristic

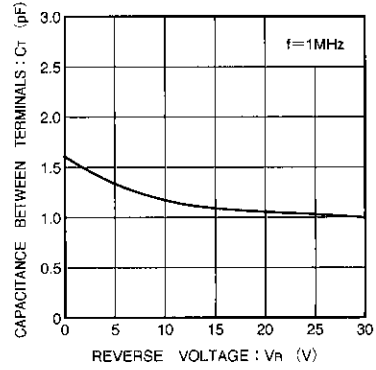

Fig. 3 Capacitance between terminals characteristic

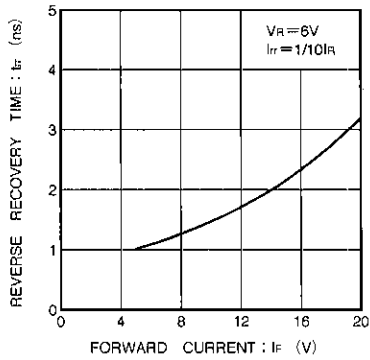

Fig. 4 Reverse recovery time characteristic

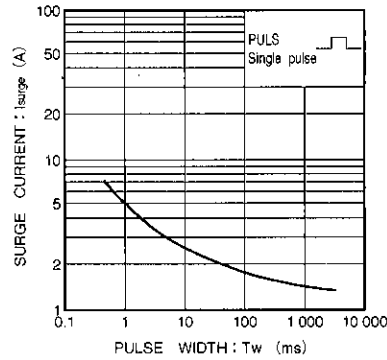
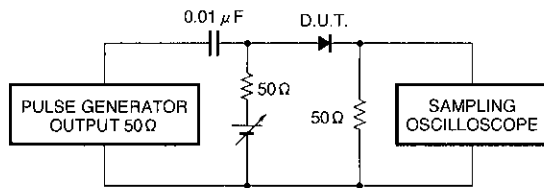

Fig. 5 Surge current characteristic



Reverse recovery time (t_{rr}) measurement circuit

Notes

- The contents described in this catalogue are correct as of March 1997.
- No unauthorized transmission or reproduction of this book, either in whole or in part, is permitted.
- The contents of this book are subject to change without notice. Always verify before use that the contents are the latest specifications. If, by any chance, a defect should arise in the equipment as a result of use without verification of the specifications, ROHM CO., LTD., can bear no responsibility whatsoever.
- Application circuit diagrams and circuit constants contained in this data book are shown as examples of standard use and operation. When designing for mass production, please pay careful attention to peripheral conditions.
- Any and all data, including, but not limited to application circuit diagrams, information, and various data, described in this catalogue are intended only as illustrations of such devices and not as the specifications for such devices. ROHM CO., LTD., disclaims any warranty that any use of such device shall be free from infringement of any third party's intellectual property rights or other proprietary rights, and further, assumes absolutely no liability in the event of any such infringement, or arising from or connected with or related to the use of such devices.
- Upon the sale of any such devices; other than for the buyer's right to use such devices itself, resell or otherwise dispose of the same; no express or implied right or license to practice or commercially exploit any intellectual property rights or other proprietary rights owned or controlled by ROHM CO., LTD., is granted to any such buyer.

The products listed in this catalogue are designed to be used with ordinary electronic equipment or devices (such as audio-visual equipment, office-automation equipment, communications devices, electrical appliances, and electronic toys). Should you intend to use these products with equipment or devices which require an extremely high level of reliability and the malfunction of which would directly endanger human life (such as medical instruments, transportation equipment, aerospace machinery, nuclear-reactor controllers, fuel controllers, or other safety devices) please be sure to consult with our sales representative in advance.

- Note when exporting
 - It is essential to obtain export permission when exporting any of the above products when it falls under the category of strategic material (or labor) as determined by foreign exchange or foreign trade control laws.
 - Please be sure to consult with our sales representatives to ascertain whether any product is classified as a strategic material.