

International
IOR Rectifier

QUIETIR Series
 20ETF.. HV

**FAST SOFT RECOVERY
 RECTIFIER DIODE**

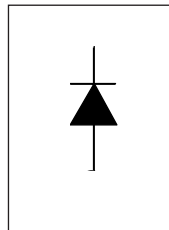

$$V_F < 1.31V @ 20A$$

$$I_{FSM} = 355A$$

$$V_{RRM} 800 \text{ to } 1200V$$

Description/Features

The 20ETF.. fast soft recovery QUIETIR rectifier series has been optimized for combined short reverse recovery time and low forward voltage drop. The glass passivation ensures stable reliable operation in the most severe temperature and power cycling conditions.

Typical applications are both:

- output rectification and freewheeling in inverters, choppers and converters
- and input rectifications where severe restrictions on conducted EMI should be met.

Major Ratings and Characteristics

Characteristics	20ETF..	Units
$I_{F(AV)}$ Sinusoidal waveform	20	A
V_{RRM} range	800 to 1200	V
I_{FSM}	355	A
V_F @ 20A, $T_J = 25^\circ C$	1.31	V
t_{rr} @ 1A, 100A/ μs	95	ns
T_J range	-40 to 150	$^\circ C$

Package Outline

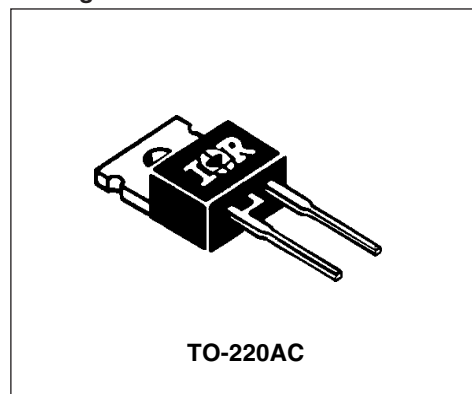

Voltage Ratings

Part Number	V_{RRM} , maximum peak reverse voltage V	V_{RSM} , maximum non repetitive peak reverse voltage V	I_{RRM} 150°C mA
20ETF08	800	900	6
20ETF10	1000	1100	
20ETF12	1200	1300	

Absolute Maximum Ratings

Parameters	20ETF..	Units	Conditions
$I_{F(AV)}$ Max. Average Forward Current	20	A	@ $T_C = 97^\circ\text{C}$, 180° conduction half sine wave
I_{FSM} Max. Peak One Cycle Non-Repetitive Surge Current	300	A	10ms Sine pulse, rated V_{RRM} applied
	355		10ms Sine pulse, no voltage reapplied
I^2t Max. I^2t for fusing	450	A^2s	10ms Sine pulse, rated V_{RRM} applied
	635		10ms Sine pulse, no voltage reapplied
$I^2\sqrt{t}$ Max. $I^2\sqrt{t}$ for fusing	6350	$A^2\sqrt{s}$	$t = 0.1$ to 10ms, no voltage reapplied

Electrical Specifications

Parameters	20ETF..	Units	Conditions
V_{FM} Max. Forward Voltage Drop	1.31	V	@ 20A, $T_J = 25^\circ\text{C}$
r_t Forward slope resistance	11.88	$m\Omega$	$T_J = 150^\circ\text{C}$
$V_{F(TO)}$ Threshold voltage	0.93	V	
I_{RM} Max. Reverse Leakage Current	0.1	mA	$T_J = 25^\circ\text{C}$
	6		$T_J = 150^\circ\text{C}$

$V_R = \text{rated } V_{RRM}$

Recovery Characteristics

Parameters	20ETF..	Units	Conditions
t_{rr} Reverse Recovery Time	400	ns	$I_F @ 20\text{Apk}$ @ 25A/ μs
I_{rr} Reverse Recovery Current	6.1	A	
Q_{rr} Reverse Recovery Charge	1.7	μC	@ 25°C
S Snap Factor t_b/t_a	0.6	typical	

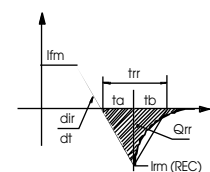

Thermal-Mechanical Specifications

Parameters	20ETF..	Units	Conditions
T_J Max. Junction Temperature Range	-40 to 150	°C	
T_{stg} Max. Storage Temperature Range	-40 to 150	°C	
R_{thJC} Max. Thermal Resistance Junction to Case	0.9	°C/W	DC operation
R_{thJA} Max. Thermal Resistance Junction to Ambient	62	°C/W	
R_{thCS} Typical Thermal Resistance, Case to Heatsink	0.5	°C/W	Mounting surface, smooth and greased
wt Approximate Weight	2 (0.07)	g (oz.)	
T Mounting Torque	Min.	6 (5)	Kg-cm (lbf-in)
	Max.	12 (10)	
Case Style	TO-220AC		

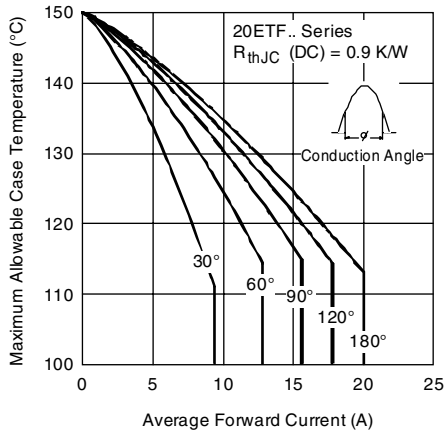

Fig. 1 - Current Rating Characteristics

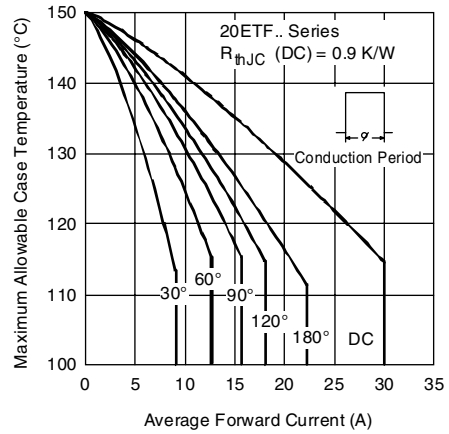

Fig. 2 - Current Rating Characteristics

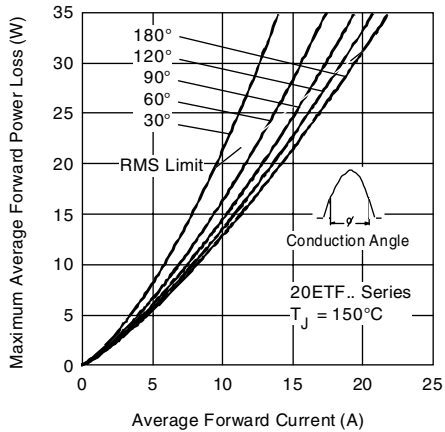

Fig. 3 - Forward Power Loss Characteristics

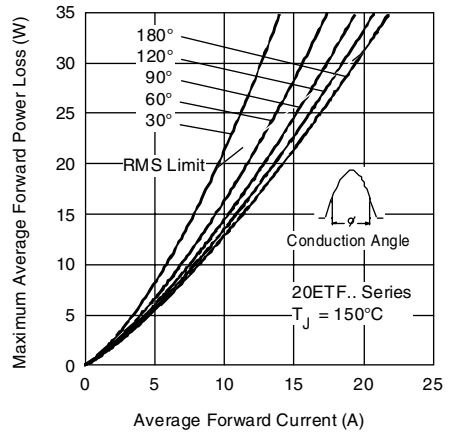

Fig. 4 - Forward Power Loss Characteristics

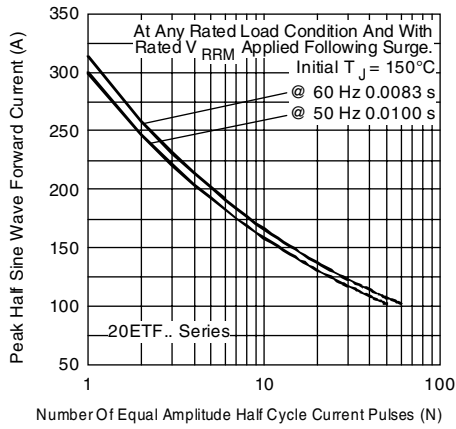

Fig. 5 - Maximum Non-Repetitive Surge Current

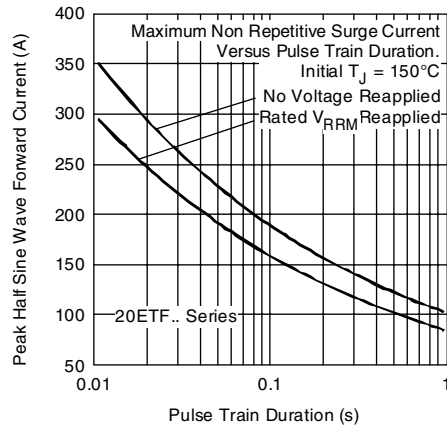

Fig. 6 - Maximum Non-Repetitive Surge Current

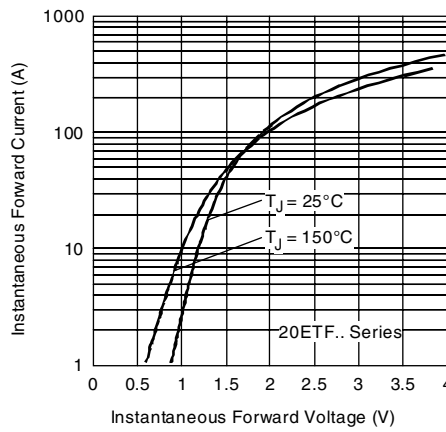

Fig. 7 - Forward Voltage Drop Characteristics

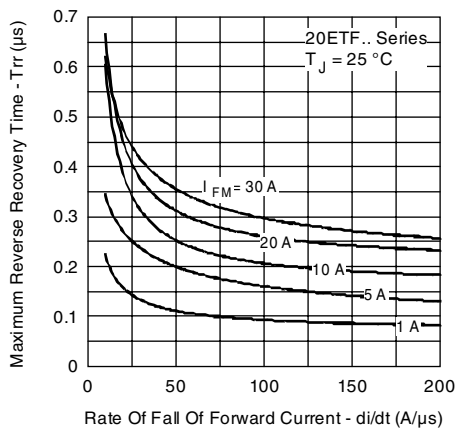

Fig. 8 - Recovery Time Characteristics, $T_J = 25^\circ\text{C}$

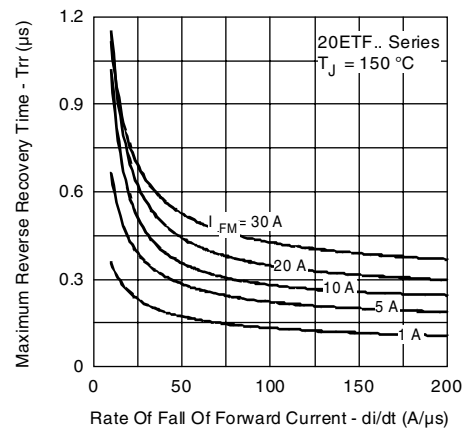

Fig. 9 - Recovery Time Characteristics, $T_J = 150^\circ\text{C}$

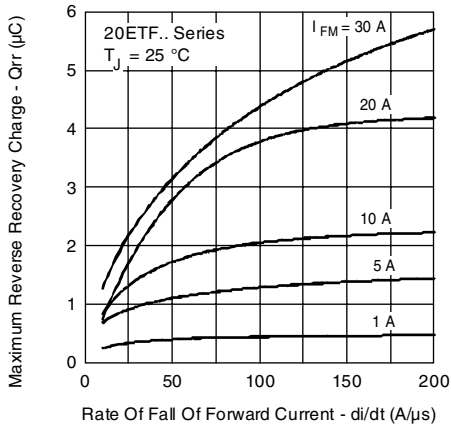

Fig. 10 - Recovery Charge Characteristics, $T_J = 25^\circ\text{C}$

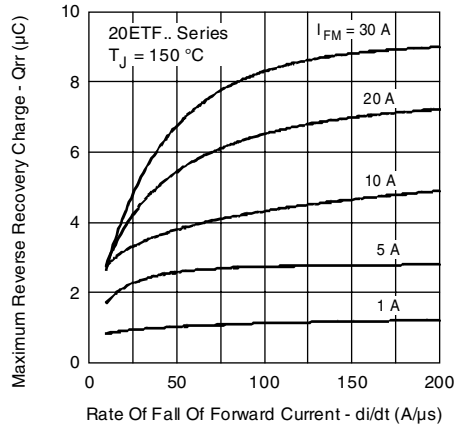

Fig. 11 - Recovery Charge Characteristics, $T_J = 150^\circ\text{C}$

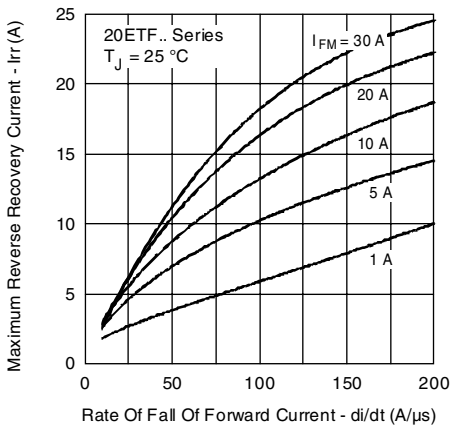

Fig. 12 - Recovery Current Characteristics, $T_J = 25^\circ\text{C}$

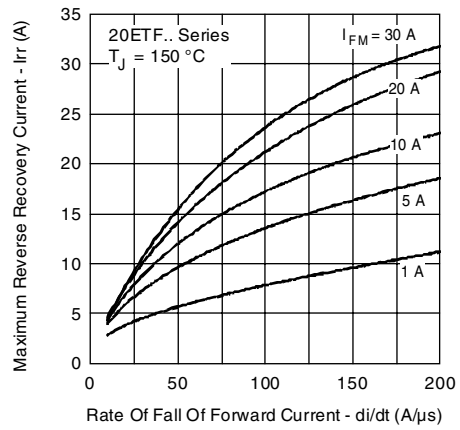

Fig. 13 - Recovery Current Characteristics, $T_J = 150^\circ\text{C}$

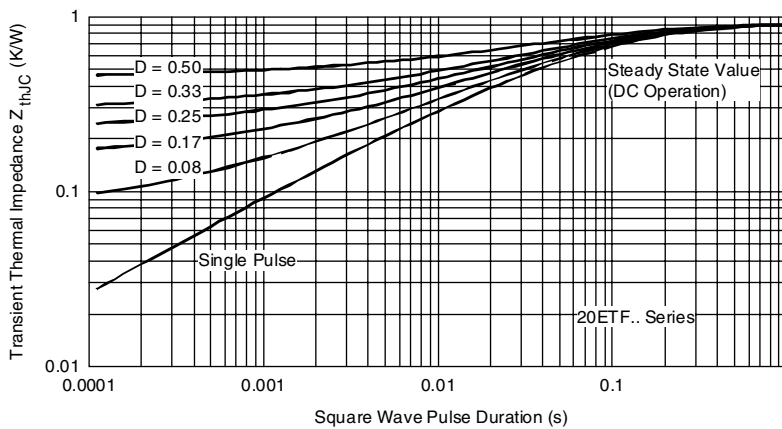
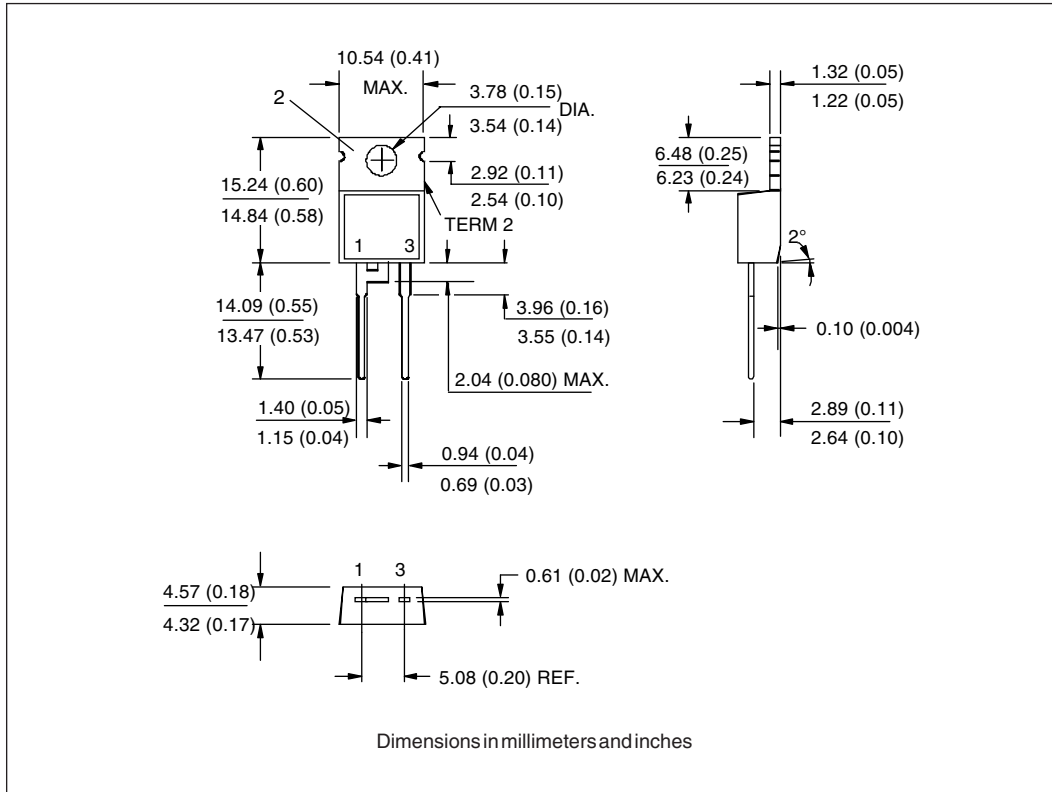
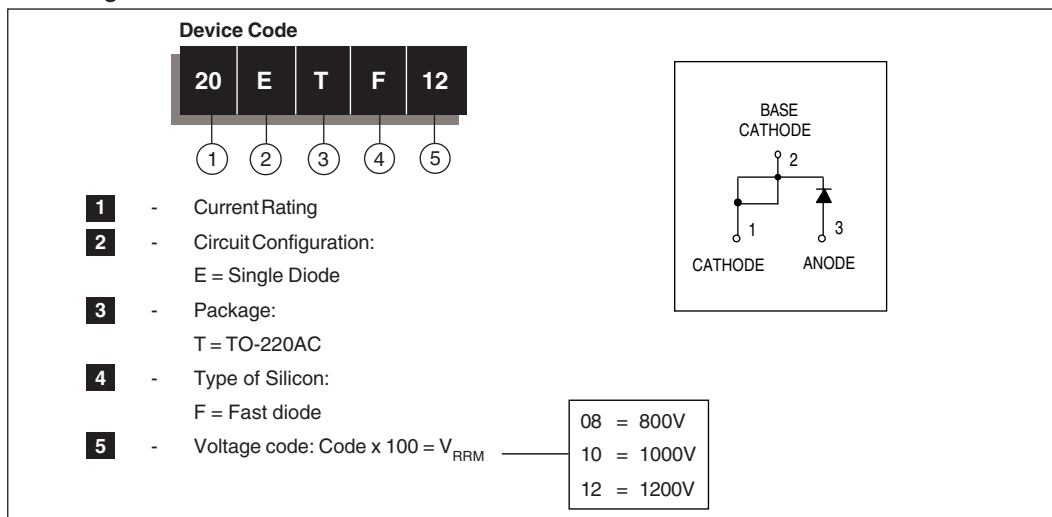

Fig. 14 - Thermal Impedance Z_{thJC} Characteristics

Outline Table



Ordering Information Table



International
IOR Rectifier

WORLD HEADQUARTERS: 233 Kansas St., El Segundo, California 90245 U.S.A Tel: (310) 322-3331 Fax: (310) 322-3332
EUROPEAN HEADQUARTERS: Hurst Green, Oxted, Surrey RH8 9BB, U.K. Tel: ++ 44 1883 732020 Fax: ++ 44 1883 733408
IR CANADA: 7231 Victoria Park Ave., Suite #201, Markham, Ontario L3R 2Z8 Tel: (905) 475 1897. Fax: (905) 475 8801
IR GERMANY: Saalburgstrasse 157, 61350 Bad Homburg Tel: ++ 49 6172 96590 Fax: ++ 49 6172 965933
IR ITALY: Via Liguria 49, 10071 Borgaro, Torino Tel: ++ 39 11 4510111 Fax: ++ 39 11 4510220
IR FAR EAST: K&H Bldg., 2F, 30-4 Nishi-Ikebukuro 3-Chome, Toshima-Ku, Tokyo, Japan 171 Tel: 81 3 3983 0086 Fax: 81 3 3983 0642
IR SOUTHEAST ASIA: 315 Outram Road, # 10-02 Tan Boon Liat Building, SINGAPORE 0316. Tel: 65 221 8371. Fax: 65 221 8372.