

International
IOR Rectifier

QUIETIR Series
 60EPF.. 60CPF..

FAST SOFT RECOVERY RECTIFIER DIODE

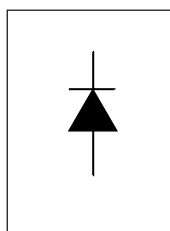

$$V_F < 1.1V @ 30A$$

$$t_{rr} = 70ns$$

$$V_{RRM} 200 \text{ to } 600V$$

Description/Features

The 60EPF.. & 60CPF.. fast soft recovery **QUIETIR** rectifier series has been optimized for combined short reverse recovery time and low forward voltage drop. The glass passivation ensures stable reliable operation in the most severe temperature and power cycling conditions.

Typical applications are both:

- Output rectification and freewheeling in inverters, choppers and converters
- and input rectifications where severe restrictions on conducted EMI should be met.

Major Ratings and Characteristics

Characteristics	60EPF.. 60CPF..	Units
$I_{F(AV)}$ Sinusoidal waveform	60	A
V_{RRM}	200 to 600	V
I_{FSM}	830	A
V_F @ 30A, $T_J=25^\circ\text{C}$	1.1	V
t_{rr} @ 1A, 100A/ μs	70	ns
T_J	-40 to 150	$^\circ\text{C}$

Package Outline

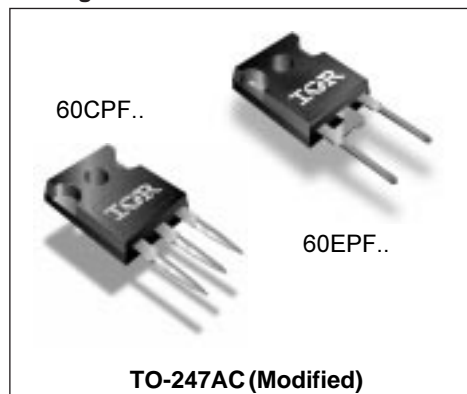

Voltage Ratings

Part Number	V_{RRM} , maximum peak reverse voltage V	V_{RSM} , maximum non repetitive peak reverse voltage V	I_{RRM} 150°C mA
60EPF02, 60CPF02	200	300	5
60EPF04, 60CPF04	400	500	
60EPF06, 60CPF06	600	700	

Absolute Maximum Ratings

Parameters	60.PF..	Units	Conditions
$I_{F(AV)}$ Max. Average Forward Current	60	A	@ $T_c = 106^\circ\text{C}$, 180° conduction half sine wave
I_{FSM} Max. Peak One Cycle Non-Repetitive Surge Current	700	A	10ms Sine pulse, rated V_{RRM} applied
	830		10ms Sine pulse, no voltage reapplied
I^2t Max. I^2t for fusing	2450	A^2s	10ms Sine pulse, rated V_{RRM} applied
	3460		10ms Sine pulse, no voltage reapplied
$I^2\sqrt{t}$ Max. $I^2\sqrt{t}$ for fusing	34600	$A^2\sqrt{s}$	$t = 0.1$ to 10ms, no voltage reapplied

Electrical Specifications

Parameters	60.PF..	Units	Conditions
V_{FM} Max. Forward Voltage Drop	1.3	V	@ 60A, $T_j = 25^\circ\text{C}$
r_t Forward slope resistance	5.0	$m\Omega$	$T_j = 150^\circ\text{C}$
$V_{F(TO)}$ Threshold voltage	0.88	V	
I_{RM} Max. Reverse Leakage Current	0.1	mA	$T_j = 25^\circ\text{C}$
	5.0		$T_j = 150^\circ\text{C}$

$V_R = \text{rated } V_{RRM}$

Typical Recovery Characteristics

Parameters	60.PF..	Units	Conditions
t_{rr} Reverse Recovery Time	180	ns	$I_F @ 60\text{Apk}$ @ 25A/ μs @ 25°C
I_{rr} Reverse Recovery Current	3.4	A	
Q_{rr} Reverse Recovery Charge	0.5	μC	
S Snap Factor t_b/t_a	0.5	typical	

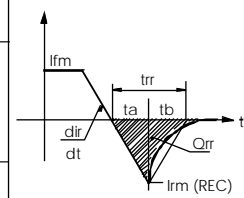

Thermal-Mechanical Specifications

Parameters		60.PF..	Units	Conditions
T_J	Max. Junction Temperature Range	-40 to 150	°C	
T_{stg}	Max. Storage Temperature Range	-40 to 150	°C	
R_{thJC}	Max. Thermal Resistance Junction to Case	0.4	°C/W	DC operation
R_{thJA}	Max. Thermal Resistance Junction to Ambient	40	°C/W	
R_{thCS}	Typical Thermal Resistance, Case to Heatsink	0.2	°C/W	Mounting surface, smooth and greased
wt	Approximate Weight	6(0.21)	g(oz.)	
T	Mounting Torque	Min.	6(5)	Kg-cm (lbf-in)
		Max.	12(10)	
Case Style		TO-247AC	JEDEC(Modified)	

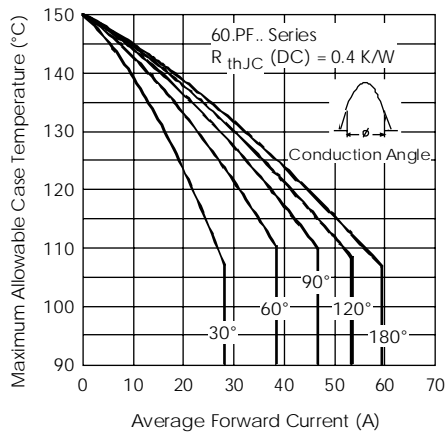

Fig. 1 - Current Rating Characteristics

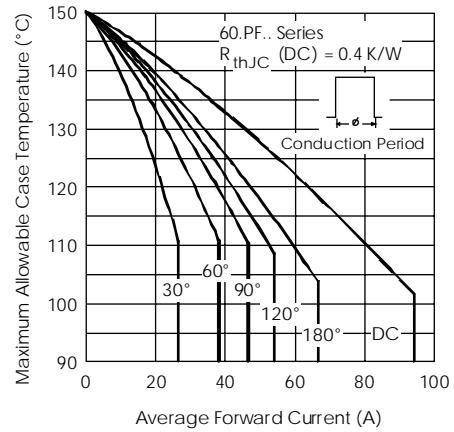

Fig. 2 - Current Rating Characteristics

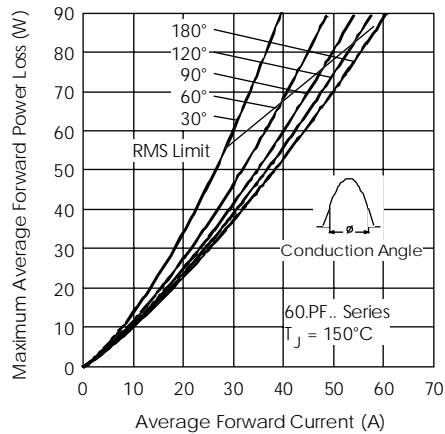

Fig. 3 - Forward Power Loss Characteristics

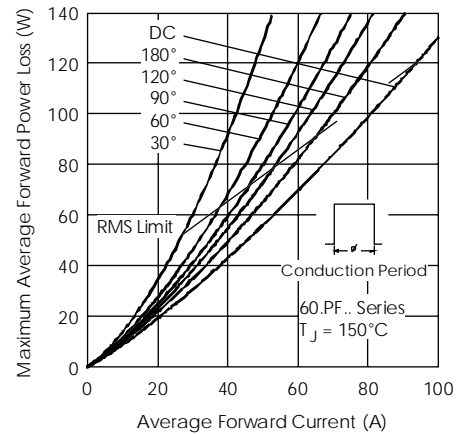

Fig. 4 - Forward Power Loss Characteristics

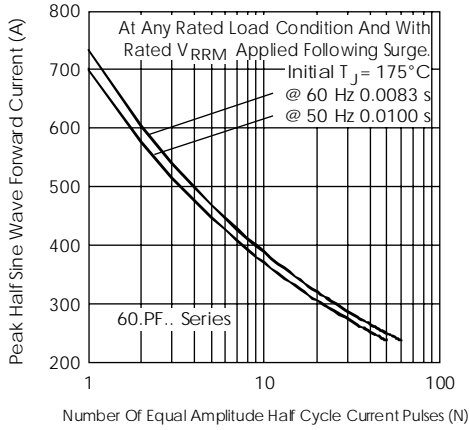

Fig. 5 - Maximum Non-Repetitive Surge Current

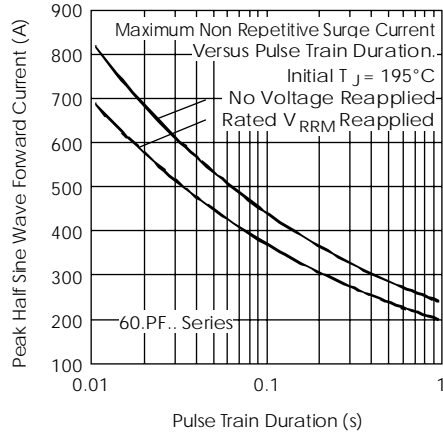

Fig. 6 - Maximum Non-Repetitive Surge Current

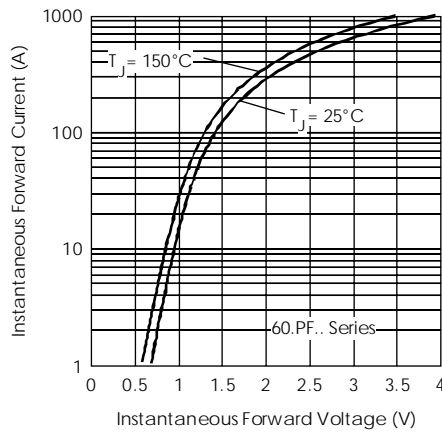

Fig. 7 - Forward Voltage Drop Characteristics

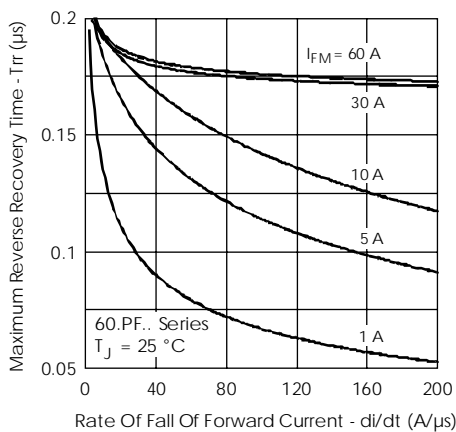

Fig. 8 - Recovery Time Characteristics, $T_J = 25^\circ\text{C}$

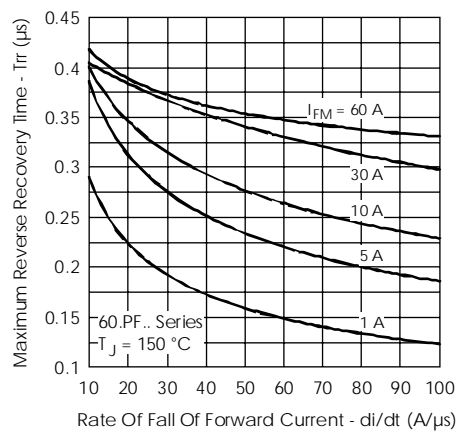

Fig. 9 - Recovery Time Characteristics, $T_J = 150^\circ\text{C}$

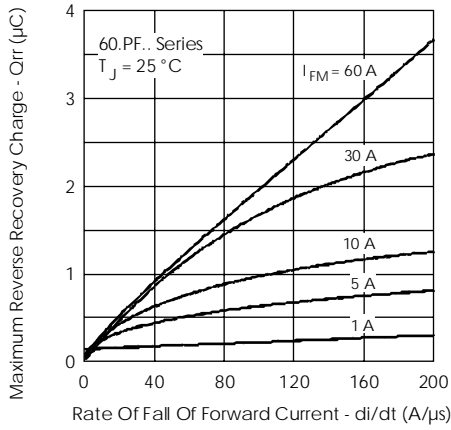

Fig. 10 - Recovery Charge Characteristics, $T_J = 25^\circ\text{C}$

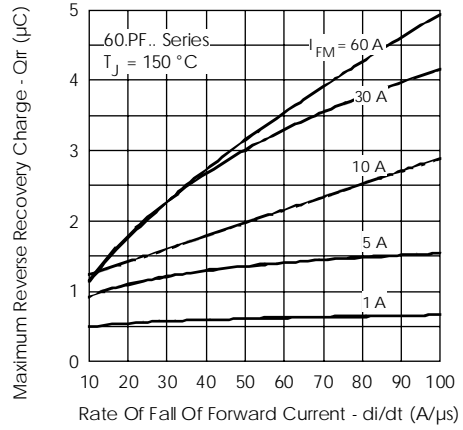

Fig. 11 - Recovery Charge Characteristics, $T_J = 150^\circ\text{C}$

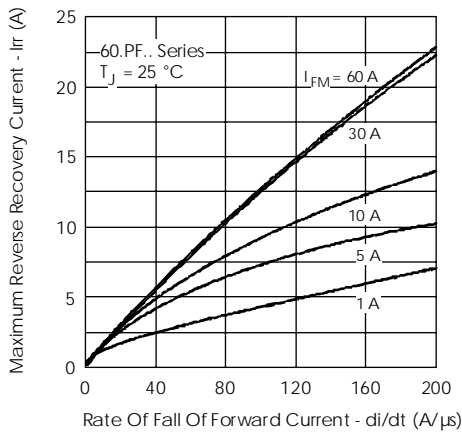

Fig. 12 - Recovery Current Characteristics, $T_J = 25^\circ\text{C}$

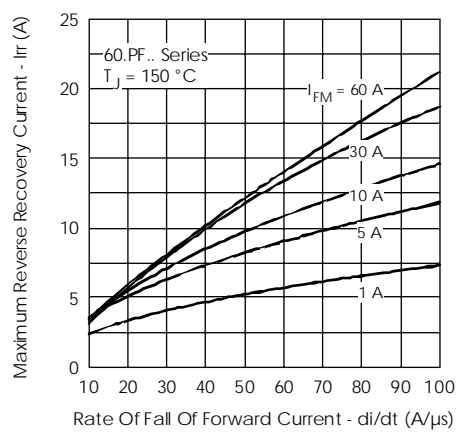

Fig. 13 - Recovery Current Characteristics, $T_J = 150^\circ\text{C}$

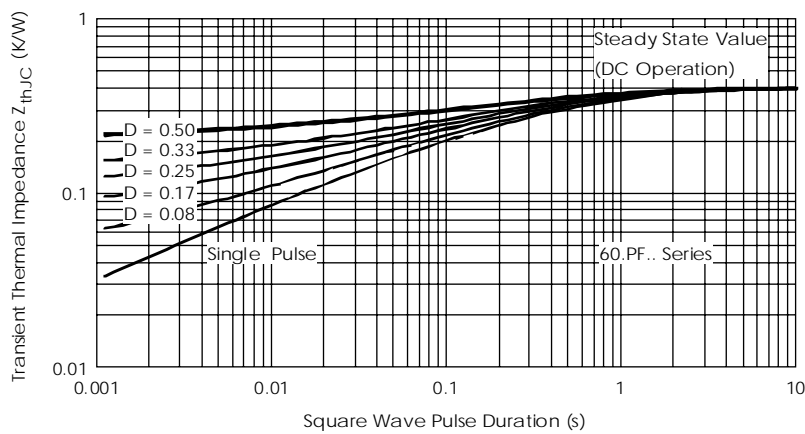
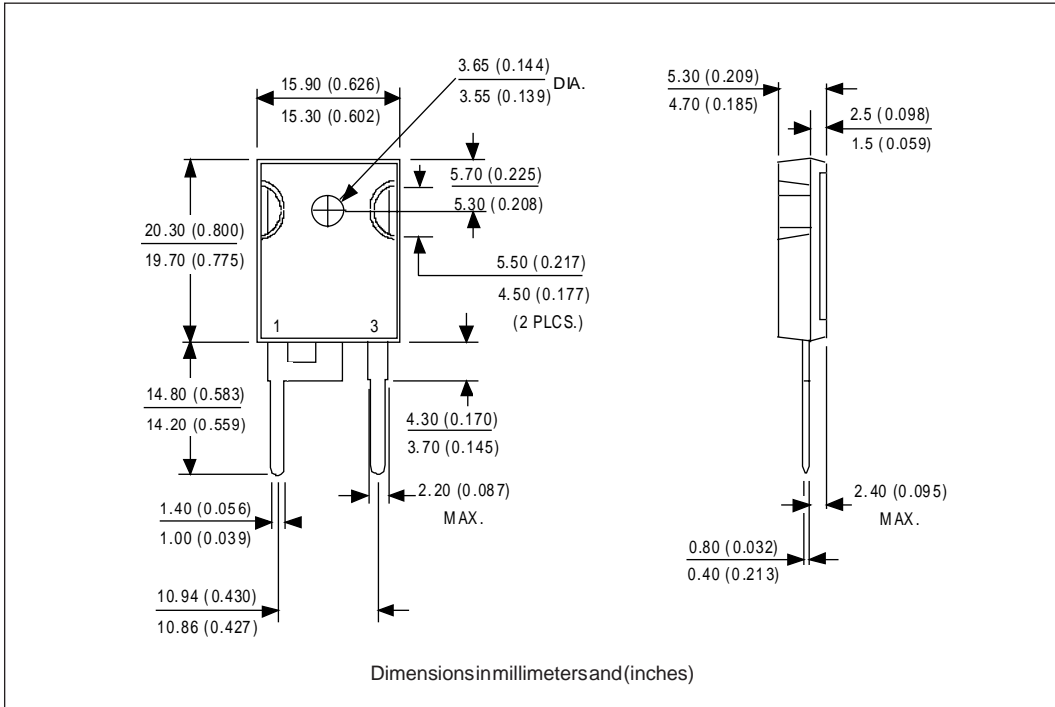
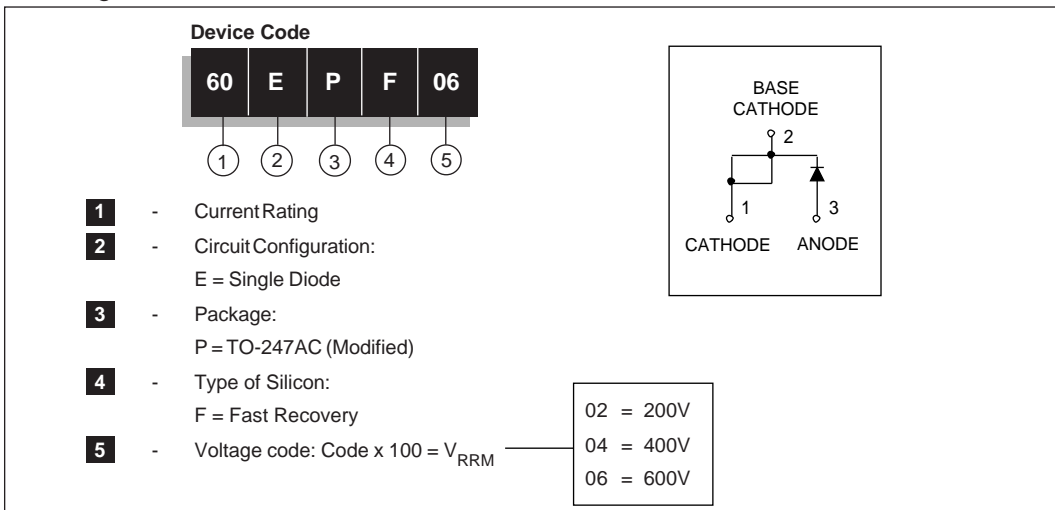

Fig. 14 - Thermal Impedance Z_{thJC} Characteristics

Outline Table



Ordering Information Table



Outline Table

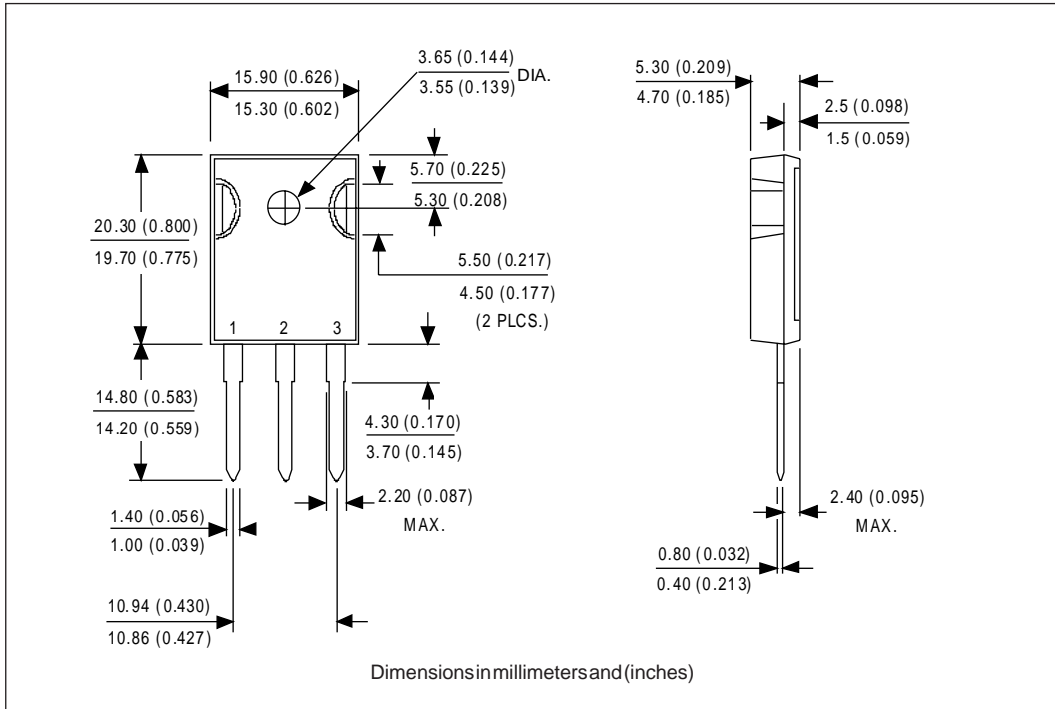

Ordering Information Table

Device Code				
60	C	P	F	06
①	②	③	④	⑤

1	-	Current Rating
2	-	Circuit Configuration: C = Single Diode, 3 pins
3	-	Package: P = TO-247AC (Modified)
4	-	Type of Silicon: F = Fast Recovery
5	-	Voltage code: Code x 100 = V_{RRM}

02	= 200V
04	= 400V
06	= 600V

Base Cathode
2

1 3
Anode Anode

WORLD HEADQUARTERS: 233 Kansas St., El Segundo, California 90245 U.S.A. Tel: (310) 322 3331. Fax: (310) 322 3332.
EUROPEAN HEADQUARTERS: Hurst Green, Oxted, Surrey RH8 9BB, U.K. Tel: ++ 44 1883 732020. Fax: ++ 44 1883 733408.
IR CANADA: 15 Lincoln Court, Brampton, Markham, Ontario L6T3Z2. Tel: (905) 453 2200. Fax: (905) 475 8801.
IR GERMANY: Saalburgstrasse 157, 61350 Bad Homburg. Tel: ++ 49 6172 96590. Fax: ++ 49 6172 965933.
IR ITALY: Via Liguria 49, 10071 Borgaro, Torino. Tel: ++ 39 11 4510111. Fax: ++ 39 11 4510220.
IR FAR EAST: K&H Bldg., 2F, 30-4 Nishi-Ikebukuro 3-Chome, Toshima-Ku, Tokyo, Japan 171. Tel: 81 3 3983 0086.
IR SOUTHEAST ASIA: 1 Kim Seng Promenade, Great World City West Tower, 13-11, Singapore 237994. Tel: ++ 65 838 4630.
IR TAIWAN: 16 Fl. Suite D.207, Sec. 2, Tun Haw South Road, Taipei, 10673, Taiwan. Tel: 886 2 2377 9936.