

FAST RECOVERY RECTIFIER DIODES

FEATURES

- VERY LOW REVERSE RECOVERY TIME
- VERY LOW SWITCHING LOSSES
- LOW NOISE TURN-OFF SWITCHING
- INSULATED PACKAGE :
Insulating voltage = 2500 V_{RMS}
Capacitance = 45 pF

DESCRIPTION

Dual high voltage rectifiers suited for Switch Mode Power Supplies and other power converters. The devices are packaged in ISOTOP.

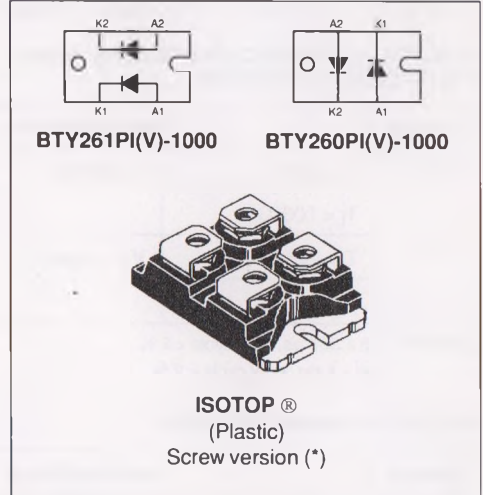

ABSOLUTE MAXIMUM RATINGS

Symbol	Parameter		Value	Unit
V _{RRM}	Repetitive peak reverse voltage		1000	V
I _{FRM}	Repetitive peak forward current	tp ≤ 10μs	750	A
I _{F(RMS)}	RMS forward current		140	A
I _{F(AV)}	Average forward current	T _C =60°C δ = 0.5	60	A
I _{FSM}	Surge non repetitive forward current	tp=10ms sinusoidal	400	A
T _{stg} T _j	Storage and junction temperature range		- 40 to + 150 - 40 to + 150	°C °C

* : Tin plated Fast-on version is also available (without V suffix).
TM : ISOTOP is a trademark of SGS-THOMSON Microelectronics.

THERMAL RESISTANCE

Symbol	Parameter		Value	Unit
Rth (j-c)	Junction to case	Per diode	0.7	°C/W
		Total	0.4	
Rth (c)	Coupling		0.1	°C/W

When the diodes 1 and 2 are used simultaneously :

$$\Delta T_j(\text{diode } 1) = P(\text{diode } 1) \times R_{th}(\text{Per diode}) + P(\text{diode } 2) \times R_{th}(c)$$

ELECTRICAL CHARACTERISTICS (Per diode)
STATIC CHARACTERISTICS

Symbol	Test Conditions		Min.	Typ.	Max.	Unit
V _F *	T _J = 25°C	I _F = 60 A			1.9	V
	T _J = 100°C				1.8	
I _R **	T _J = 25°C	V _R = V _{RRM}			100	μA
	T _J = 100°C				6	mA

Pulse test : * tp = 380 μs, duty cycle < 2 %

** tp = 5 ms, duty cycle < 2 %

RECOVERY CHARACTERISTICS

Symbol	Test Conditions		Min.	Typ.	Max.	Unit
trr	T _J = 25°C	I _F = 0.5A I _{rr} = 0.25A I _R = 1A			70	ns
		I _F = 1A dI _F /dt = -15A/μs V _R = 30V			170	

TURN-OFF SWITCHING CHARACTERISTICS (Without serie inductance)

Symbol	Test Conditions		Min.	Typ.	Max.	Unit
t _{IRM}	dI _F /dt = -240A/μs	V _{CC} = 200V I _F = 60A L _p ≤ 0.05μH T _J = 100°C see fig. 11			200	ns
	dI _F /dt = -480A/μs			120		
I _{RM}	dI _F /dt = -240A/μs				40	A
	dI _F /dt = -480A/μs			44		

TURN-OFF OVERVOLTAGE COEFFICIENT (With serie inductance)

Symbol	Test Conditions		Min.	Typ.	Max.	Unit
$C = \frac{V_{RP}}{V_{CC}}$	T _J = 100°C V _{CC} = 200V I _F = I _{F(AV)} dI _F /dt = -60A/μs L _p = 2.5μH see fig.12			3.3	4.5	/

To evaluate the conduction losses use the following equation :

$$P = 1.47 \times I_{F(AV)} + 0.005 \times I_{F(RMS)}^2$$

Fig.1 : Low frequency power losses versus average current.

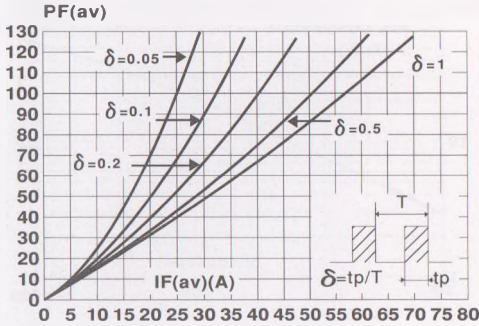

Fig.2 : Peak current versus form factor.

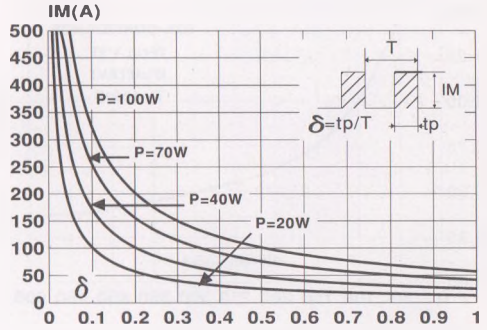

Fig.3 : Non repetitive peak surge current versus overload duration.

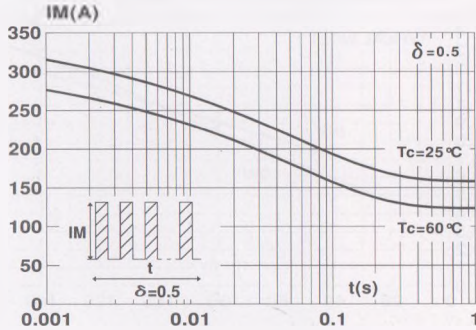

Fig.4 : Relative variation of thermal impedance junction to case versus pulse duration.

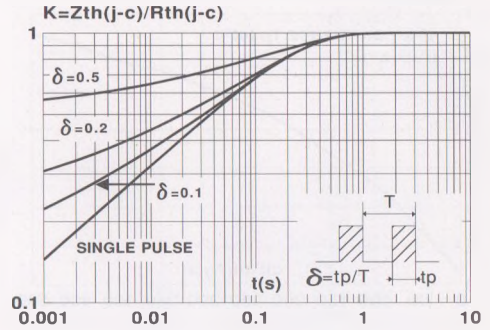

Fig.5 : Voltage drop versus forward current.

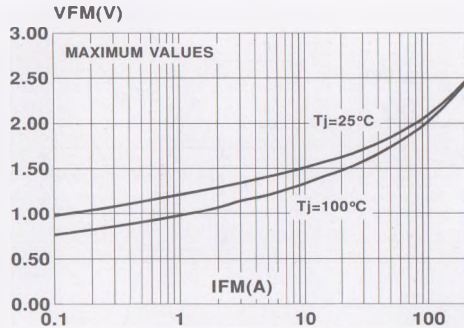

Fig.6 : Recovery charge versus diF/dt.

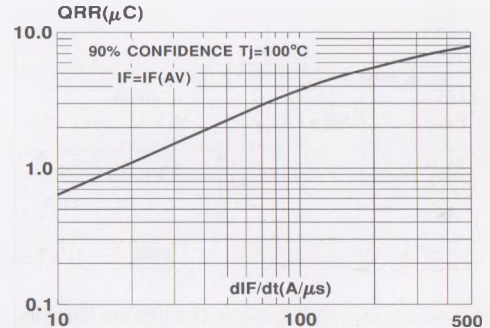

Fig.7 : Recovery time versus diF/dt .

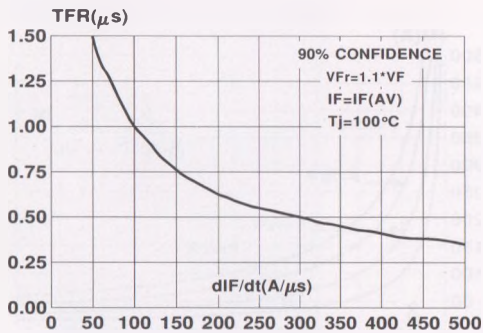

Fig.8 : Peak reverse current versus diF/dt .

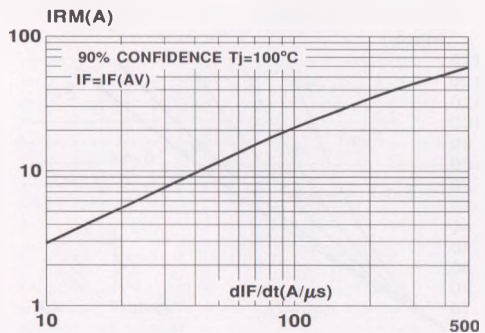

Fig.9 : Peak forward voltage versus diF/dt .

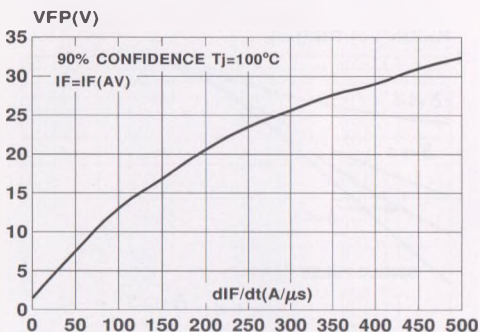

Fig.10 : Dynamic parameters versus junction temperature.

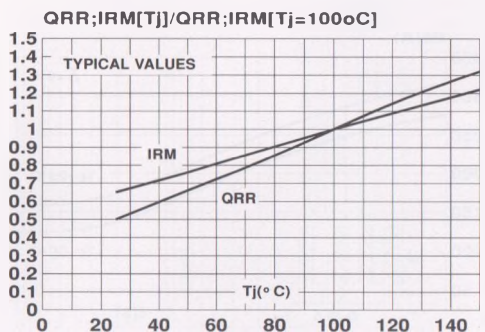

Fig.11 : TURN-OFF SWITCHING CHARACTERISTICS (Without serie inductance)

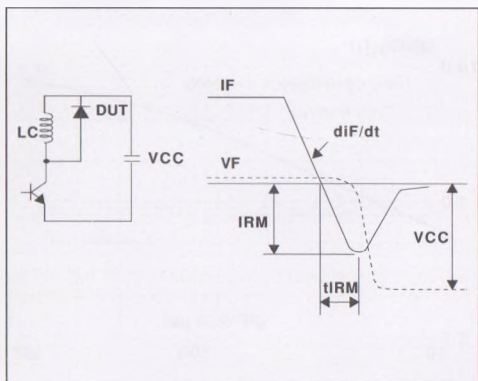

Fig.12 : TURN-OFF SWITCHING CHARACTERISTICS (With serie inductance)

