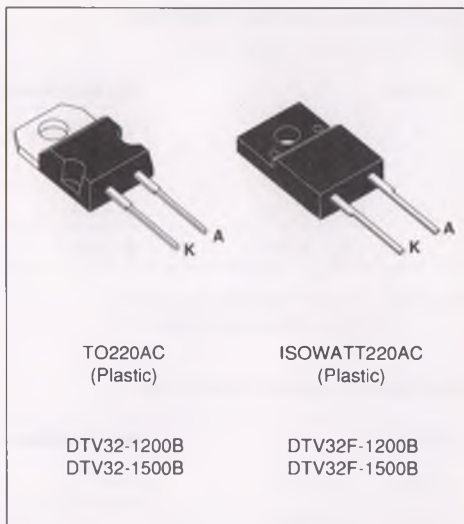

(CRT HORIZONTAL DEFLECTION)
HIGH VOLTAGE DAMPER DIODE
FEATURES

- HIGH BREAKDOWN VOLTAGE CAPABILITY
- HIGH FREQUENCY OPERATION
- SPECIFIED TURN ON SWITCHING CHARACTERISTICS
- TYPICAL TOTAL LOSSES : 3.5W
($I_{Fpeak} = 6\text{ A}$, $F = 64\text{ kHz}$)
- SUITABLE WITH **BUH** TRANSISTORS SERIES
- INSULATED VERSION (ISOWATT220AC) :
Insulating voltage = 2000 V DC
Capacitance = 12 pF

DESCRIPTION

High voltage diode especially designed for horizontal deflection stage in standard and high resolution displays for TV's and monitors. This device is packaged in TO220AC or ISOWATT220AC.

ABSOLUTE MAXIMUM RATINGS

Symbol	Parameter		Value	Unit	
$I_F(RMS)$	RMS forward current		15	A	
$I_F(AV)$	Average forward current $\delta = 0.5$	TO220AC	$T_C = 130^\circ\text{C}$	6	A
		ISOWATT220AC	$T_C = 110^\circ\text{C}$		
I_{FSM}	Surge non repetitive forward current		$t_p = 10\text{ms}$ sinusoidal	100	A
T_{stg} T_j	Storage and junction temperature range		- 40 to + 150 - 40 to + 150	$^\circ\text{C}$ $^\circ\text{C}$	

Symbol	Parameter	DTV32(F)-		Unit
		1200B	1500B	
V_{RRM}	Repetitive peak reverse voltage	1200	1500	V
V_{RWM}	Reverse working voltage	1000	1350	V

THERMAL RESISTANCES

Symbol	Parameter		Value	Unit
Rth (j-c)	Junction to case	TO220AC	2	°C/W
		ISOWATT220AC	4	

ELECTRICAL CHARACTERISTICS

STATIC CHARACTERISTICS

Symbol	Test Conditions		Min.	Typ.	Max.	Unit
I _R *	T _j = 25°C	V _R = V _{RWM}			200	μA
	T _j = 100°C				1	mA
V _F **	T _j = 25°C	I _F = 6 A			1.5	V
	T _j = 100°C	I _F = 6 A			1.4	

Pulse test : * tp = 5 ms, duty cycle < 2 %

** tp = 380 μs, duty cycle < 2 %

RECOVERY CHARACTERISTICS

Symbol	Test Conditions		Min.	Typ.	Max.	Unit
trr (1)	T _j = 25°C	I _F = 1 A V _R = 30 V			175	ns
trr (1)	T _j = 25°C		dI _F /dt = -50 A/μs			
				250		ns
trr	T _j = 25°C	I _F = 100mA	I _R = 100mA		140	ns

TURN ON SWITCHING CHARACTERISTICS

Symbol	Test Conditions		Min.	Typ.	Max.	Unit
t _{FR} (2)	T _j = 100°C	I _F = 6 A		0.6		μs
V _{FP} (2)		V _{FR} = 2 V	dI _F /dt = 80 A/μs		39	V

(1) Test following Jedec Standard

(2) Test representative of the application

To evaluate the conduction losses use the following equations :

$$V_F = 1.2 + 0.034 I_F$$

$$P = 1.2 \times I_{F(AV)} + 0.034 \times I_F^2_{(RMS)}$$

Fig.1 : Average forward power dissipation versus average forward current.

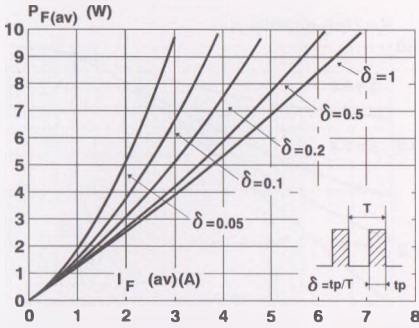

Fig.2 : Peak current versus form factor.

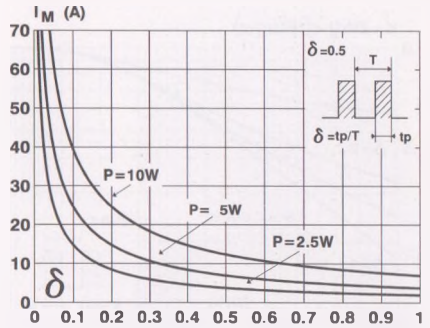

Fig.3 : Average current versus ambient temperature. (duty cycle : 0.5) (TO220AC)

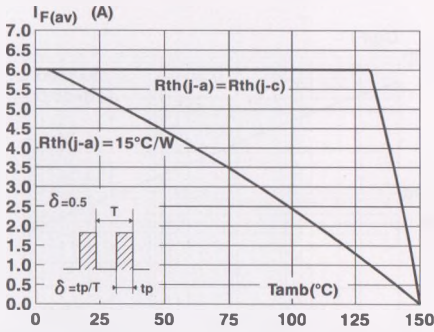

Fig.4 : Average current versus ambient temperature. (duty cycle : 0.5) (ISOWATT220AC)

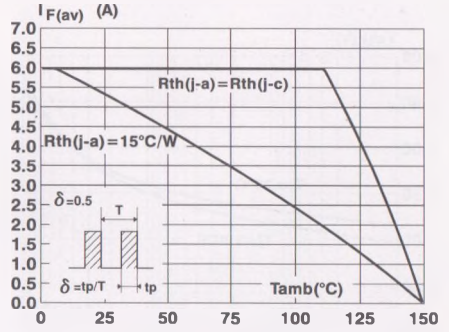

Fig.5 : Non repetitive surge peak forward current versus overload duration. (Maximum values) (TO220AC)

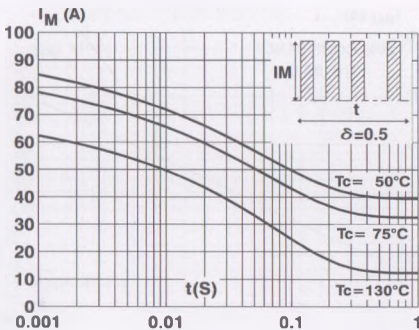

Fig.6 : Non repetitive surge peak forward current versus overload duration. (Maximum values) (ISOWATT220AC)

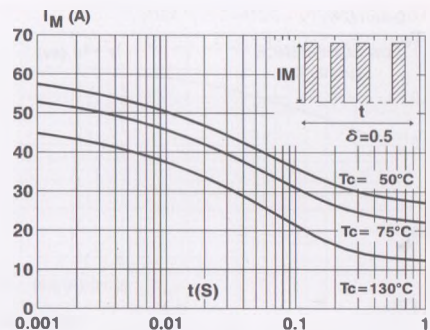

Fig.7 : Relative variation of thermal transient impedance junction to case versus pulse duration. (TO220AC)

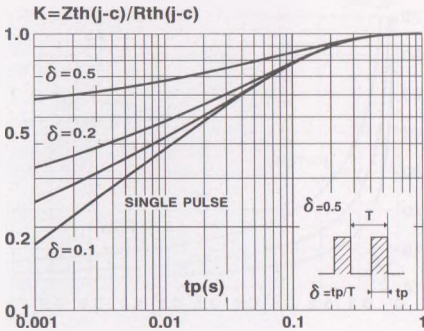

Fig.8 : Relative variation of thermal transient impedance junction to case versus pulse duration. (ISOWATT220AC)

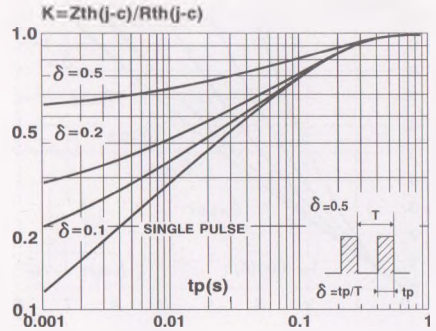

Fig.9 : Forward voltage drop versus forward current. (Maximum values)

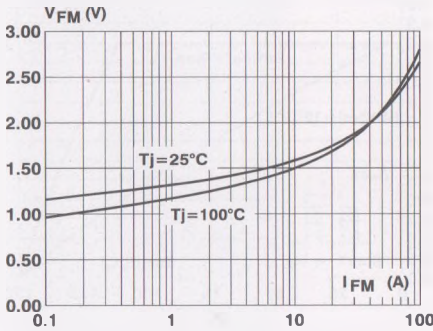

Fig.10 : Junction capacitance versus reverse voltage applied. (Typical values)

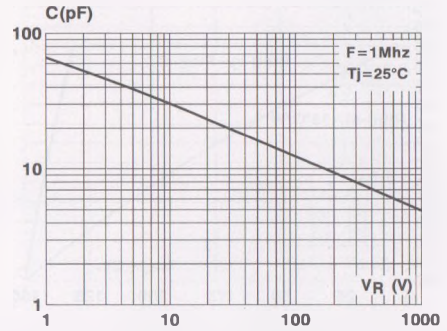

Fig.11 : Recovery charge versus dIF/dt.

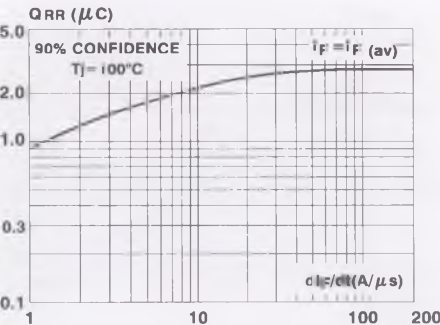

Fig.12 : Peak reverse current versus dIF/dt.

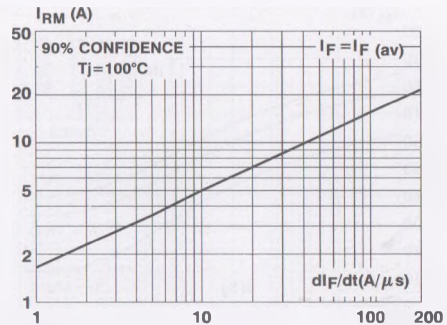

Fig.13 : Dynamic parameters versus junction temperature.

Fig.14 : Peak forward voltage versus dI_F/dt .

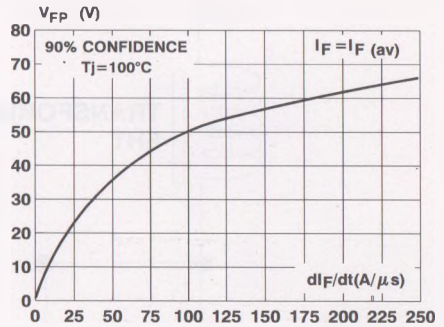
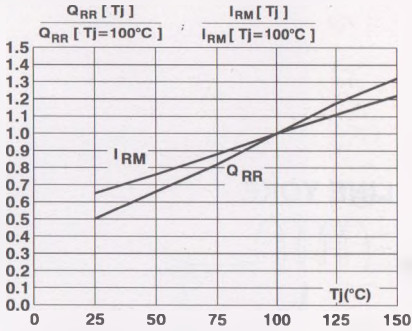
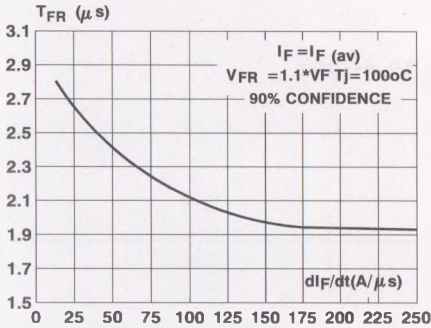
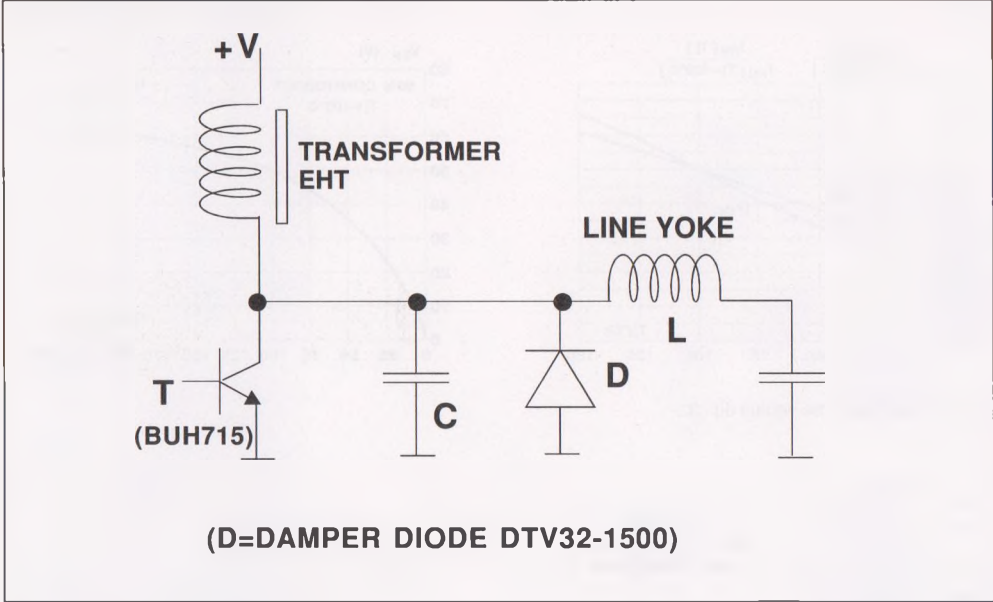

Fig.15 : Recovery time versus dI_F/dt .



BASIC HORIZONTAL DEFLECTION CIRCUIT



BASIC E-W DIODE MODULATOR CIRCUIT

