

## BIDIRECTIONAL TRISIL

- CHARACTERISTIC OF STAND-OFF AND BREAKDOWN VOLTAGE SIMILAR TO A TRISIL ( $V_{off}$ )
- HIGH FLOWOUT CAPABILITY BECAUSE OF ITS BREAKOVER CHARACTERISTICS ( $V_{on}$ )
- AUTOMATIC RECOVERY AFTER SURGE

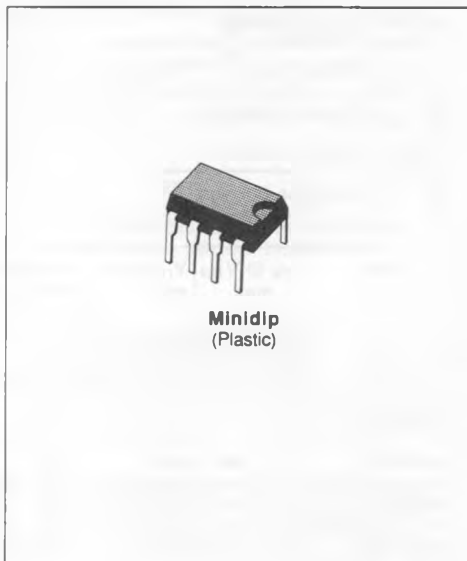

### DESCRIPTION

The LS5018B, LS5060B and LS5120B/B1 are bidirectional transient overvoltage suppressor designed to protect sensitive components in electronic telephones and telecommunication equipments against transient caused by lightning, induction from power lines, etc.

### ABSOLUTE RATINGS (limiting values) ( $T_j = 25\text{ }^\circ\text{C}$ )

Symbol	Parameter	Value	Unit
$I_{pp}$	Peak Pulse Current	1 ms expo	100
		8-20 $\mu\text{s}$ expo*	500
$I_{TSM}$	Non Repetitive Surge Peak on-state Current	$t_p = 20\text{ ms} - \text{Sinus}$	50
$di/dt$	Critical Rate of Rise of on-state Current	Non repetitive	100
$T_{stg}$ $T_j$	Storage and Junction Temperature Range	- 40 to 150	$^\circ\text{C}$
		150	$^\circ\text{C}$

### THERMAL RESISTANCE

Symbol	Parameter	Value	Unit
$R_{th(j-a)}$	Junction to Ambient	80	$^\circ\text{C/W}$

\* ANSI STD C62.

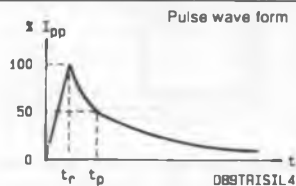

**ELECTRICAL CHARACTERISTICS**

(T<sub>j</sub> = 25 °C)

Symbol	Parameter
V <sub>RM</sub>	Stand-off Voltage
V <sub>BR</sub>	Breakdown Voltage
V <sub>BO</sub>	Clamping Voltage
I <sub>H</sub>	Holding Current
V <sub>T</sub>	On-state Voltage @ I <sub>T</sub>
I <sub>BO</sub>	Breakover Current
I <sub>pp</sub>	Peak-pulse Current

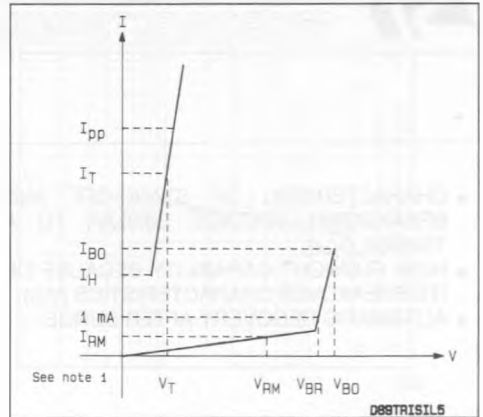

Type	I <sub>RM</sub> @ V <sub>RM</sub> max.		V <sub>(BR)</sub> @ I <sub>R</sub> min.		V <sub>BO</sub> @ max. min. typ. max. See note 2			I <sub>H</sub> min.	V <sub>T</sub> typ. I <sub>T</sub> = 1 A	C max. V <sub>R</sub> = 5 V F = 1 MHz
	(μA)	(V)	(V)	(mA)	(V)	(mA)	(mA)	(mA)	(V)	(pF)
LS5018B	5	16	17	1	22		1300	200	2	150
LS5060B	10	50	60	1	85		1000	200	2	150
LS5120B	20	100	120	1	180	500	1250	250	2	150
LS5120B1	20	100	120	1	180	500	1250	200	2	150

- Notes : 1. Same characteristic both sides.  
 2. These devices are not designed to function as zeners ; continuous operation between 1 mA and I<sub>BO</sub> will damage them.

**PACKAGE MECHANICAL DATA**

MINIDIP Plastic

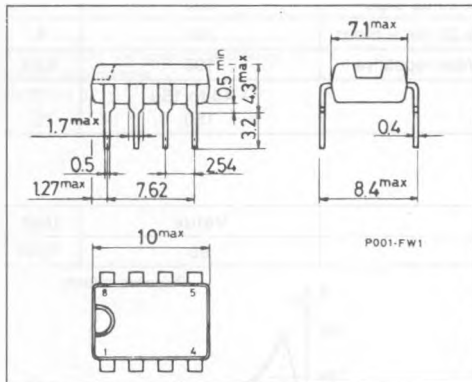

**CONNECTION DIAGRAM**

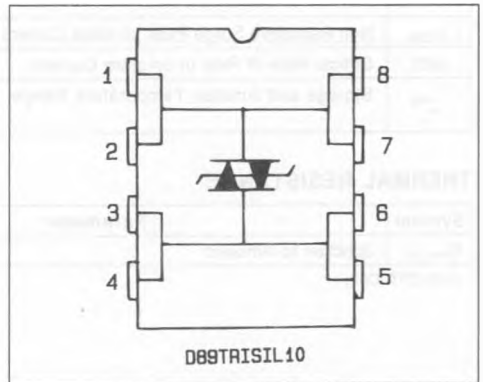

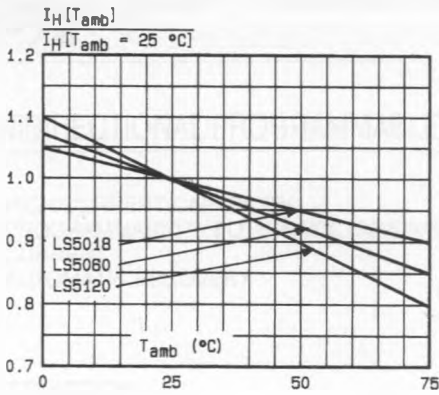

Fig. 1 - Relative variation of holding current versus ambient temperature.

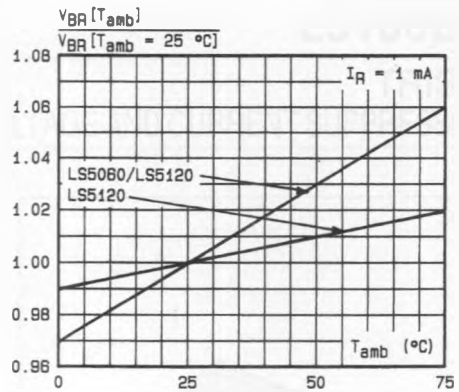

Fig. 2 - Relative variation of breakdown voltage versus ambient temperature.

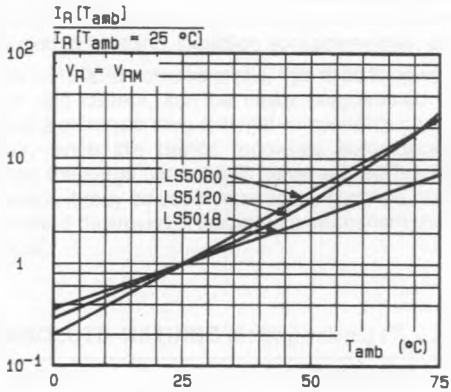

Fig. 3 - Relative variation of leakage current versus ambient temperature.

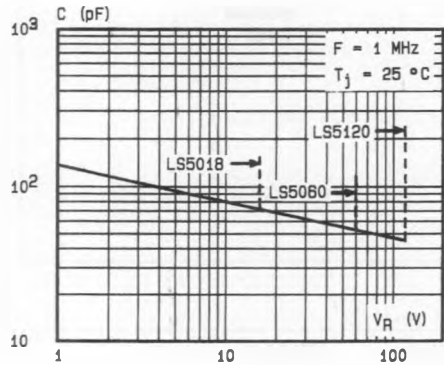

Fig. 4 - Junction capacitance versus reverse applied voltage.

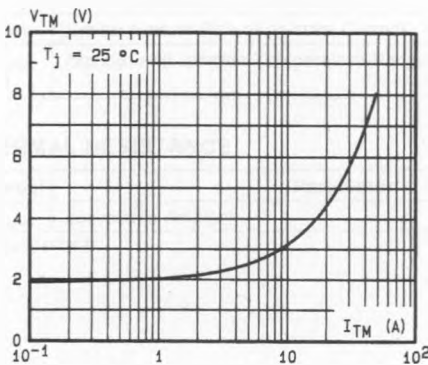

Fig. 5 - On-state voltage versus on-state current (typical values).

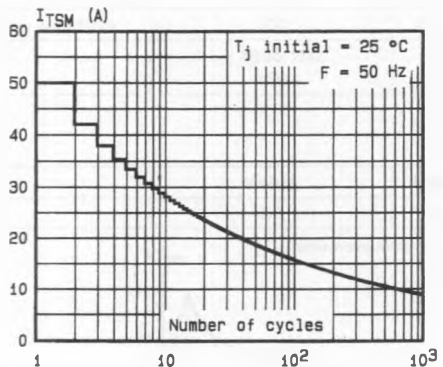

Fig. 6 - Non repetitive surge peak on-state current versus number of cycles.