

**FEATURES**

- PEAK PULSE POWER : 1500 W (10/1000µs)
- BREAKDOWN VOLTAGE RANGE :  
From 6.8 V to 220 V
- UNI AND BIDIRECTIONAL TYPES
- LOW CLAMPING FACTOR
- FAST RESPONSE TIME
- UL RECOGNIZED

**DESCRIPTION**

Transil diodes provide high overvoltage protection by clamping action. Their instantaneous response to transient overvoltages makes them particularly suited to protect voltage sensitive devices such as MOS Technology and low voltage supplied IC's.

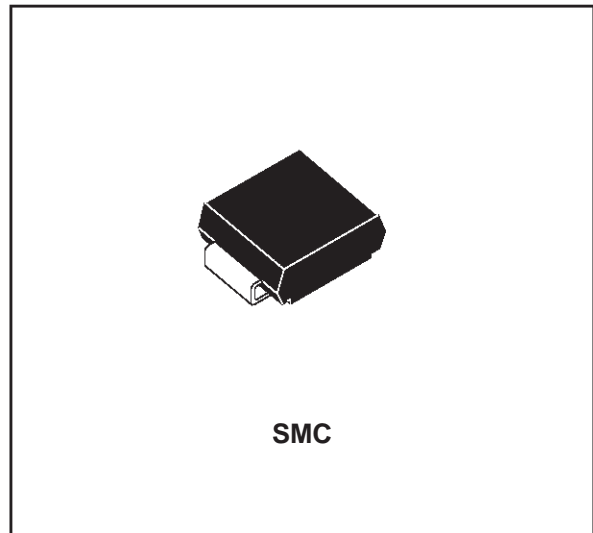

**ABSOLUTE MAXIMUM RATINGS** ( $T_{amb} = 25^{\circ}C$ )

Symbol	Parameter		Value	Unit
PPP	Peak pulse power dissipation (see note1)	$T_j \text{ initial} = T_{amb}$	1500	W
P	Power dissipation on infinite heatsink	$T_{amb} = 50^{\circ}C$	6.5	W
$I_{FSM}$	Non repetitive surge peak forward current for unidirectional types	$t_p = 10ms$ $T_j \text{ initial} = T_{amb}$	200	A
$T_{stg}$ $T_j$	Storage temperature range Maximum junction temperature		- 65 to + 175 150	$^{\circ}C$ $^{\circ}C$
$T_L$	Maximum lead temperature for soldering during 10 s.		260	$^{\circ}C$

**Note 1 :** For a surge greater than the maximum values, the diode will fail in short-circuit.

**THERMAL RESISTANCES**

Symbol	Parameter	Value	Unit
$R_{th(j-l)}$	Junction to leads	15	$^{\circ}C/W$
$R_{th(j-a)}$	Junction to ambient on printed circuit on recommended pad layout	75	$^{\circ}C/W$

# SM15Txx

## ELECTRICAL CHARACTERISTICS

(T<sub>amb</sub> = 25°C)

Symbol	Parameter
V <sub>RM</sub>	Stand-off voltage
V <sub>BR</sub>	Breakdown voltage
V <sub>CL</sub>	Clamping voltage
I <sub>RM</sub>	Leakage current @ V <sub>RM</sub>
I <sub>PP</sub>	Peak pulse current
αT	Voltage temperature coefficient
V <sub>F</sub>	Forward Voltage drop

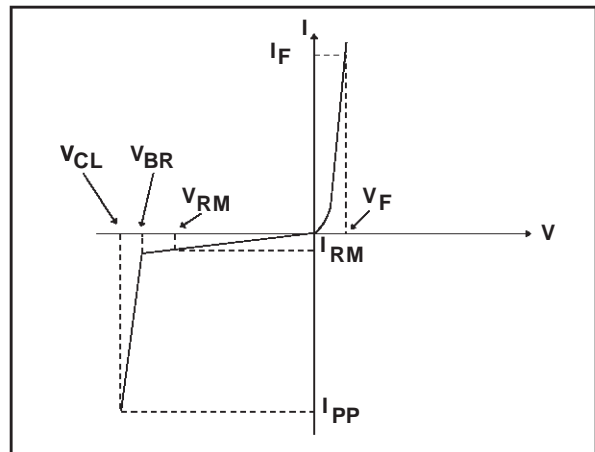

Types				I <sub>RM</sub> @ V <sub>RM</sub> max		V <sub>BR</sub> @ I <sub>R</sub> min nom max note2				V <sub>CL</sub> @ I <sub>PP</sub> max 10/1000μs		V <sub>CL</sub> @ I <sub>PP</sub> max 8/20μs		αT max note3	C typ note4
Uni-directional	Mar-king	Bi-directional	Mar-king	μA	V	V	V	V	mA	V	A	V	A	10 <sup>-4</sup> °C	pF
SM15T6V8A	MDE	SM15T6V8CA	BDE	1000	5.8	6.45	6.8	7.14	10	10.5	143	13.4	746	5.7	9500
SM15T7V5A	MDG	SM15T7V5CA	BDG	500	6.4	7.13	7.5	7.88	10	11.3	132	14.5	690	6.1	8500
SM15T10A	MDP	SM15T10CA	NDP	10	8.55	9.5	10	10.5	1	14.5	103	18.6	538	7.3	7000
SM15T12A	MDT	SM15T12CA	BDT	5	10.2	11.4	12	12.6	1	16.7	90	21.7	461	7.8	6000
SM15T15A	MDX	SM15T15CA	BDX	5	12.8	14.3	15	15.8	1	21.2	71	27.2	368	8.4	5000
SM15T18A	MEE	SM15T18CA	BEE	5	15.3	17.1	18	18.9	1	25.2	59.5	32.5	308	8.8	4300
SM15T22A	MEK	SM15T22CA	BEK	5	18.8	20.9	22	23.1	1	30.6	49	39.3	254	9.2	3700
SM15T24A	MEM	SM15T24CA	BEM	5	20.5	22.8	24	25.2	1	33.2	45	42.8	234	9.4	3500
SM15T27A	MEP	SM15T27CA	BEP	5	23.1	25.7	27	28.4	1	37.5	40	48.3	207	9.6	3200
SM15T30A	MER	SM15T30CA	BER	5	25.6	28.5	30	31.5	1	41.5	36	53.5	187	9.7	2900
SM15T33A	MET	SM15T33CA	BET	5	28.2	31.4	33	34.7	1	45.7	33	59.0	169	9.8	2700
SM15T36A	MEV	SM15T36CA	BEV	5	30.8	34.2	36	37.8	1	49.9	30	64.3	156	9.9	2500
SM15T39A	MEX	SM15T39CA	BEX	5	33.3	37.1	39	41.0	1	53.9	28	69.7	143	10.0	2400
SM15T68A	MFP	SM15T68CA	BFP	5	58.1	64.6	68	71.4	1	92	16.3	121	83	10.4	1550
SM15T100A	MFX	SM15T100CA	BFX	5	85.5	95.0	100	105	1	137	11	178	56	10.6	1150
SM15T150A	MGK	SM15T150CA	BGK	5	128	143	150	158	1	207	7.2	265	38	10.8	850
SM15T200A	MGV	SM15T200CA	BGV	5	171	190	200	210	1	274	5.5	353	28	10.8	675
SM15T220A	MGX	SM15T220CA	BGX	5	188	209	220	231	1	328	4.6	388	26	10.8	625

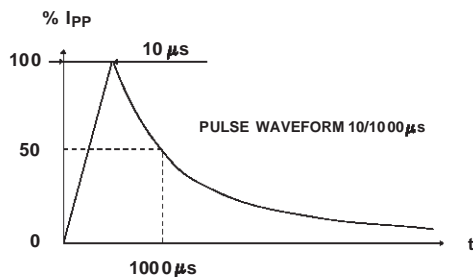

**Note 2 :** Pulse test: t<sub>p</sub> < 50 ms.

**Note 3 :** ΔV<sub>BR</sub> = αT \* (T<sub>amb</sub> - 25) \* V<sub>BR</sub>(25°C).

**Note 4 :** V<sub>R</sub> = 0 V, F = 1 MHz. For bidirectional types, capacitance value is divided by 2.

**Fig. 1:** Peak pulse power dissipation versus initial junction temperature (printed circuit board).

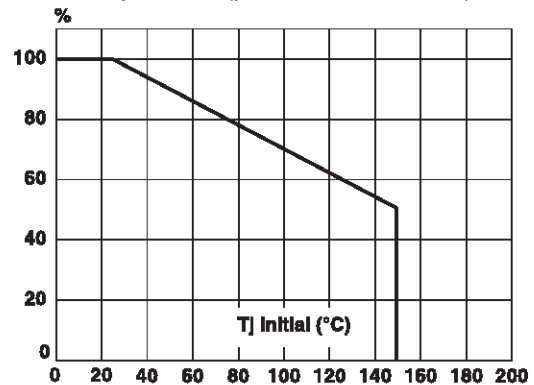

Fig. 2 : Peak pulse power versus exponential pulse duration.

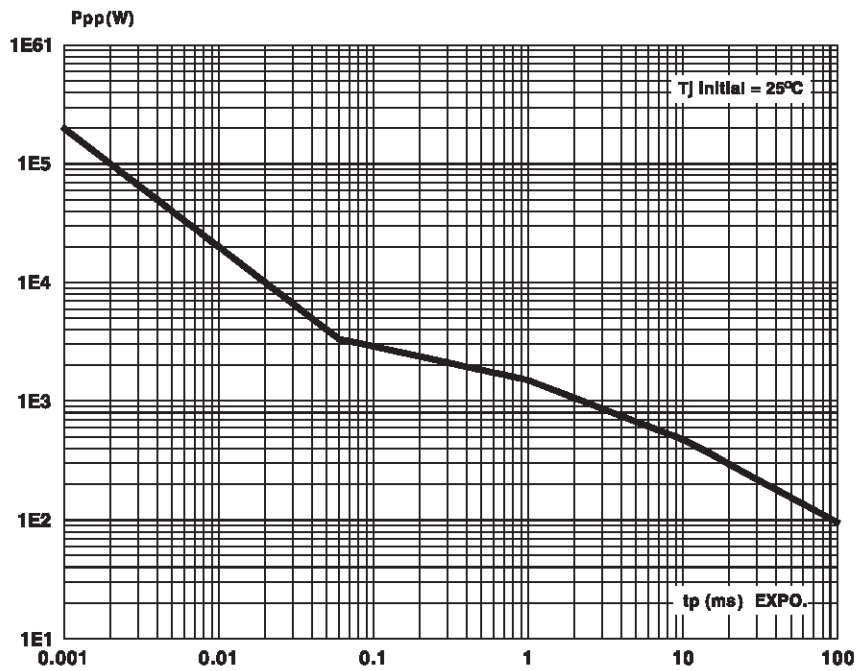
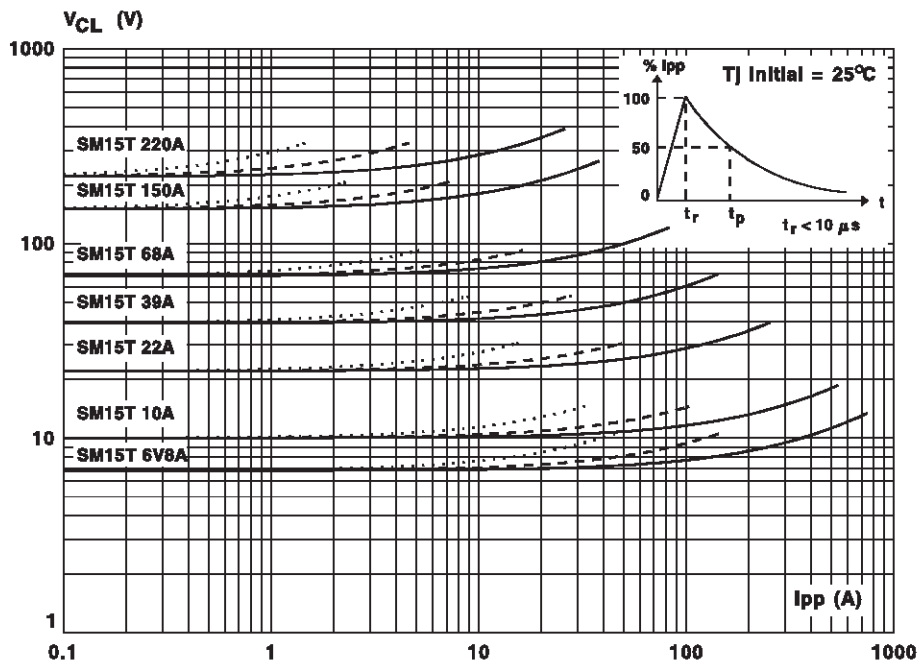

Fig. 3 : Clamping voltage versus peak pulse current.  
 Exponential waveform  $t_p = 20 \mu s$  ———  
 $t_p = 1 ms$  - - - - -  
 $t_p = 10 ms$  ······



**Note :** The curves of the figure 3 are specified for a junction temperature of 25 °C before surge.  
 The given results may be extrapolated for other junction temperatures by using the following formula :  
 $\Delta V_{BR} = \alpha T \cdot [T_{amb} - 25] \cdot V_{BR}(25^\circ C)$ .  
 For intermediate voltages, extrapolate the given results.

## SM15Txx

Fig. 4a : Capacitance versus reverse applied voltage for unidirectional types (typical values).

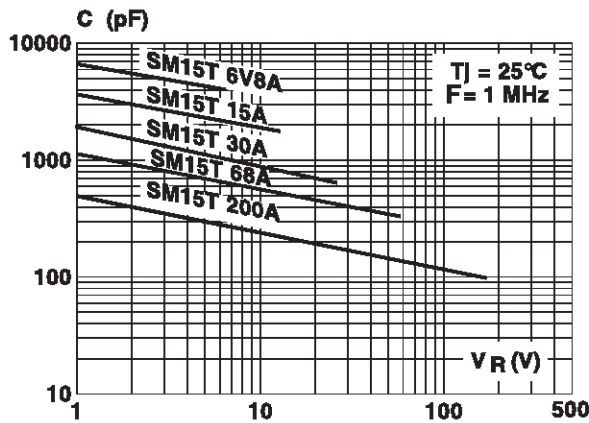

Fig. 4b : Capacitance versus reverse applied voltage for bidirectional types (typical values).

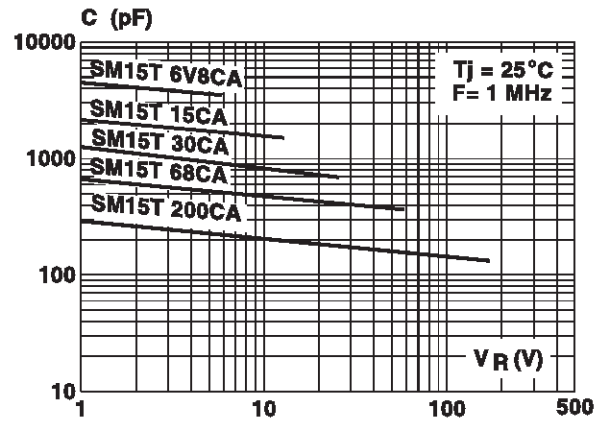

Fig. 5 : Peak forward voltage drop versus peak forward current (typical values for unidirectional types).

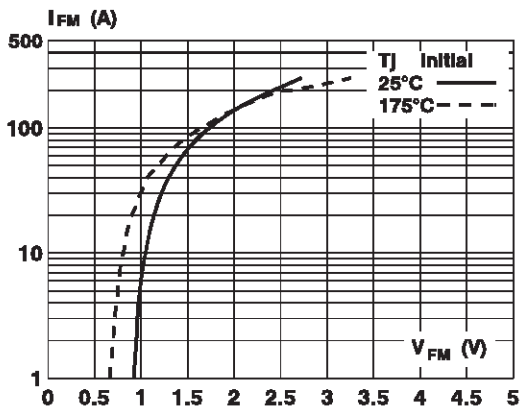

Fig. 6 : Transient thermal impedance junction-ambient versus pulse duration. Mounting on FR4 PC Board with recommended pad layout.

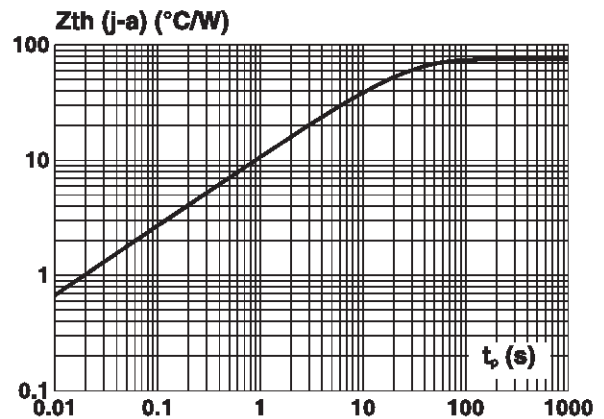
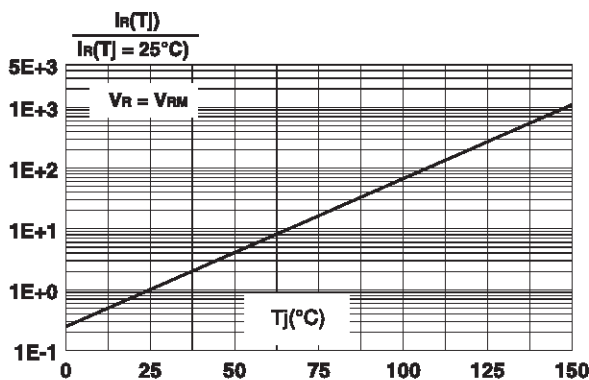
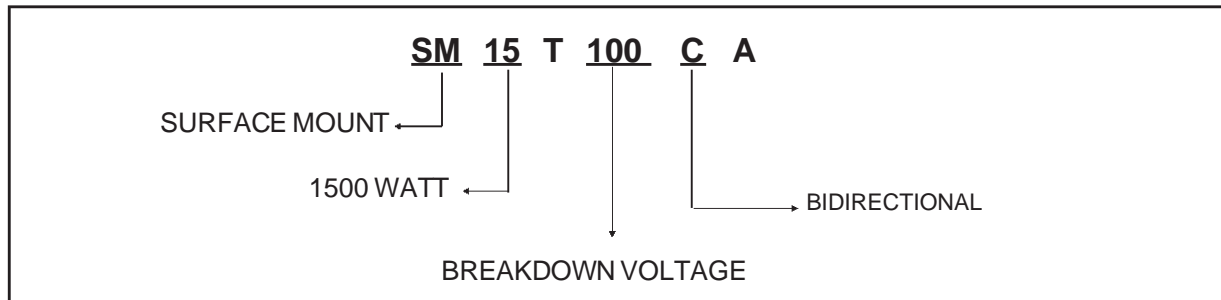

Fig. 7 : Relative variation of leakage current versus junction temperature.



**ORDER CODE**



**MARKING** : Logo, Date Code, Type Code, Cathode Band (for unidirectional types only).

**PACKAGE MECHANICAL DATA**

SMC (Plastic)

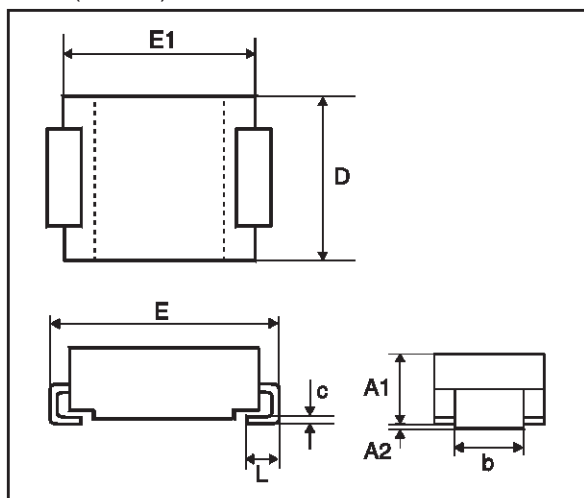

REF.	DIMENSIONS					
	Millimeters			Inches		
	Min.	Typ.	Max.	Min.	Typ.	Max.
A1	2.40	2.70	3.00	0.094	0.106	0.118
A2	0.05		0.20	0.002		0.008
b	2.90		3.10	0.114		0.122
c	0.29		0.32	0.011		0.013
E1	6.30	6.40	6.60	0.248	0.252	0.260
D	4.80	5.00	5.20	0.189	0.197	0.205
E	7.60	7.80	8.00	0.299	0.307	0.315
L	1.30		1.70	0.051		0.067

**Weight** = 0.25 g.

**FOOTPRINT DIMENSIONS (Millimeters)**

SMC

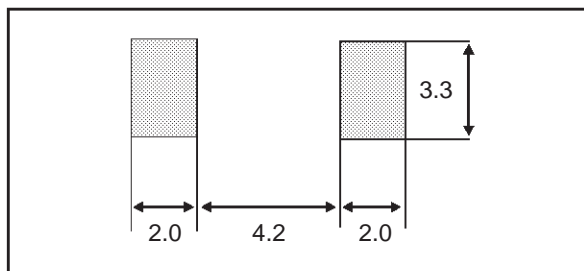

**Packaging** : standard packaging is in tape and reel.

Information furnished is believed to be accurate and reliable. However, SGS-THOMSON Microelectronics assumes no responsibility for the consequences of use of such information nor for any infringement of patents or other rights of third parties which may result from its use. No license is granted by implication or otherwise under any patent or patent rights of SGS-THOMSON Microelectronics. Specifications mentioned in this publication are subject to change without notice. This publication supersedes and replaces all information previously supplied. SGS-THOMSON Microelectronics products are not authorized for use as critical components in life support devices or systems without express written approval of SGS-THOMSON Microelectronics.

© 1998 SGS-THOMSON Microelectronics - Printed in Italy - All rights reserved.

SGS-THOMSON Microelectronics GROUP OF COMPANIES

Australia - Brazil - Canada - China - France - Germany - Italy - Japan - Korea - Malaysia - Malta - Morocco  
The Netherlands - Singapore - Spain - Sweden - Switzerland - Taiwan - Thailand - United Kingdom - U.S.A.