

POWER SCHOTTKY RECTIFIER
MAIN PRODUCT CHARACTERISTICS

$I_{F(AV)}$	2 x 3 A
V_{RRM}	45 V
V_F	0.57 V

FEATURES AND BENEFITS

- VERY SMALL CONDUCTION LOSSES
- NEGLIGIBLE SWITCHING LOSSES
- HIGH AVALANCHE CAPABILITY
- HIGH DISSIPATION MINIATURE PACKAGE
- SURFACE MOUNT TECHNOLOGY COMPATIBLE

DESCRIPTION

Dual schottky rectifier suited for switchmode power supply and high frequency DC to DC converters.

Packaged in a high performance surface mount package PSO-10, this device is intended for use in low voltage, high frequency inverters, free wheeling and polarity protection applications.

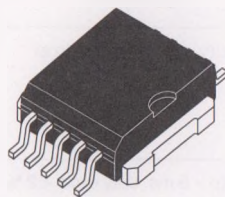

Power SO-10™
 Plastic, non isolated SMD
 with copper tab

ABSOLUTE MAXIMUM RATINGS

Symbol	Parameter			Value	Unit
V_{RRM}	Repetitive Peak Reverse Voltage			40	V
$I_{F(RMS)}$	RMS Forward Current	All pins connected	Per diode	11	A
$I_{F(AV)}$	Average Forward Current $\delta = 0.5$	$T_c = 135^\circ\text{C}$	Per diode	3	A
			Per device	6	
I_{FSM}	Surge Non Repetitive Forward Current	$t_p = 10 \text{ ms}$ Sinusoidal All pins connected	Per diode	75	A
I_{RRM}	Repetitive Peak Reverse Current	$t_p = 2 \mu\text{s}$ $F = 1\text{KHz}$	Per diode	1	A
T_{stg} T_j	Storage and Junction Temperature Range			- 65 to + 150	$^\circ\text{C}$
dV/dt	Critical Rate of Rise of Reverse Voltage			1000	V/ μs

TM : ISOTOP is a trademark of SGS-THOMSON Microelectronics.

STPS640CM

THERMAL RESISTANCES

Symbol	Parameter		Value	Unit
$R_{TH(j-c)}$	Junction to Case Thermal Resistance	Per diode total	5.5 3.0	$^{\circ}\text{C}/\text{W}$
$R_{TH(c)}$	Coupling Thermal Resistance		0.5	$^{\circ}\text{C}/\text{W}$

STATIC ELECTRICAL CHARACTERISTICS (Per diode)

Symbol	Tests Conditions	Tests Conditions		Min.	Typ.	Max.	Unit
I_R^*	Reverse leakage Current	$T_j = 25^{\circ}\text{C}$	$V_R = V_{RRM}$			100	μA
		$T_j = 125^{\circ}\text{C}$				10	mA
V_F^{**}	Forward Voltage drop	$T_j = 125^{\circ}\text{C}$	$I_F = 6\text{ A}$			0.72	V
		$T_j = 125^{\circ}\text{C}$	$I_F = 3\text{ A}$			0.57	
		$T_j = 25^{\circ}\text{C}$	$I_F = 6\text{ A}$			0.84	

Pulse test : * $t_p = 5\text{ ms}$, duty cycle $< 2\%$

** $t_p = 380\text{ }\mu\text{s}$, duty cycle $< 2\%$

To evaluate the conduction losses use the following equation :

$$P = 0.42 \times I_{F(AV)} + 0.050 I_{F(RMS)}^2$$

PIN OUT configuration in PowerSO-10 :

Anode 1 = pin 1 to 5

Anode 2 = pin 6 to 10

Cathodes = connected to base tab

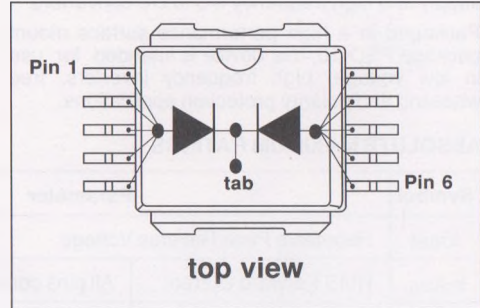

Fig. 1 : Average forward power dissipation versus average forward current. (Per diode)

Fig. 2 : Average current versus ambient temperature.

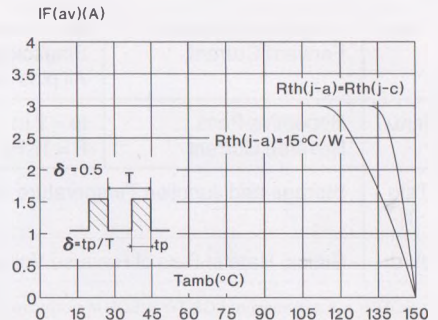
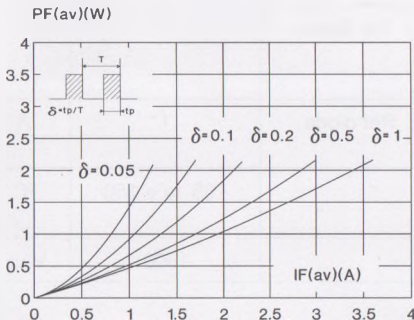

Fig. 3 : Non repetitive surge peak forward current versus overload duration. (Maximum values) (Per diode)

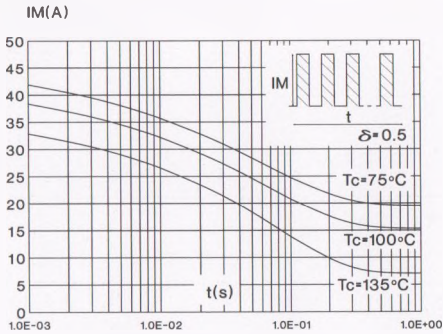

Fig. 4 : Relative variation of thermal transient impedance junction to case versus pulse duration.

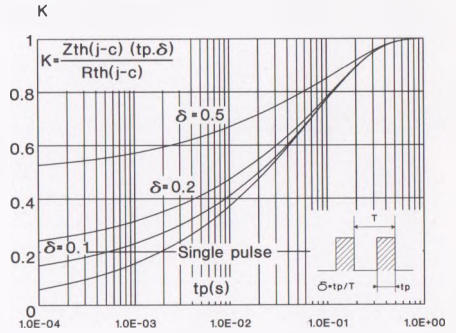

Fig. 5 : Reverse leakage current versus reverse voltage applied. (Typical values) (Per diode)

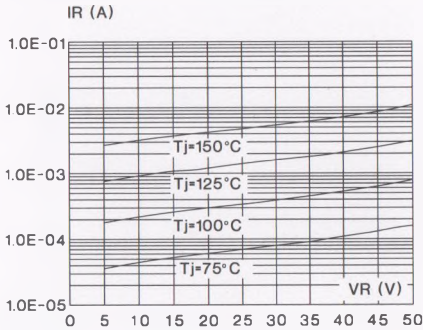

Fig. 6 : Junction capacitance versus reverse voltage applied. (Typical values) (Per diode)

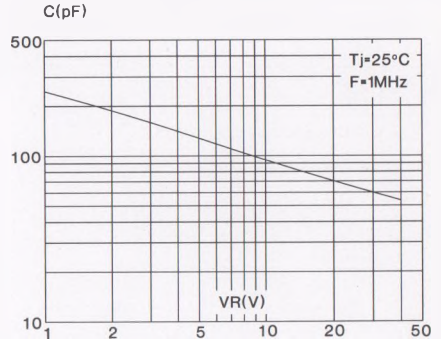

Fig. 7 : Forward voltage drop versus forward current. (Maximum values) (Per diode)

