

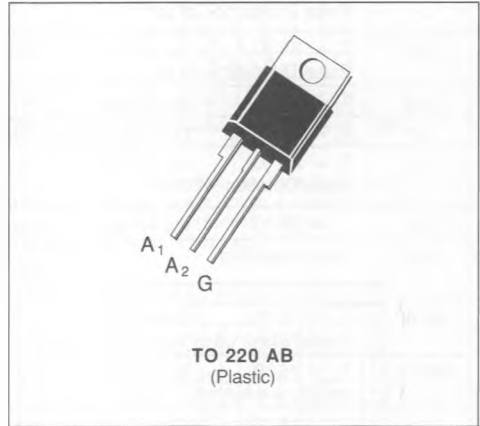

**TRIACS**

- GLASS PASSIVATED CHIP
- EXCELLENT  $(dv/dt)_c > 10 \text{ V}/\mu\text{s}$
- $I_{GT}$  SPECIFIED IN FOUR QUADRANTS
- AVAILABLE IN INSULATED VERSION → BTA SERIES (INSULATING VOLTAGE 2500  $V_{RMS}$ ) OR IN UNINSULATED VERSION → BTB SERIES
- UL RECOGNIZED FOR BTA SERIES (E81734)



**DESCRIPTION**

New range suited for applications such as phase control and static switching.

**ABSOLUTE RATINGS** (limiting values)

Symbol	Parameter	Value	Unit
$I_{T(RMS)}$	RMS on-state Current (360° conduction angle)	$T_C = 75 \text{ }^\circ\text{C}$ 10	A
$I_{TSM}$	Non Repetitive Surge Peak on-state Current ( $T_j$ initial = 25 °C - Half sine wave)	$t = 8.3 \text{ ms}$	100
		$t = 10 \text{ ms}$	100
$I^2t$	$I^2t$ Value for Fusing	$t = 10 \text{ ms}$ 50	$\text{A}^2\text{s}$
$di/dt$	Critical Rate of Rise of on-state Current (1)	Repetitive $F = 50 \text{ Hz}$	10
		Non Repetitive	50
$T_{stg}$ $T_j$	Storage and Operating Junction Temperature Range	- 40 to 150	$^\circ\text{C}$
		- 40 to 110	$^\circ\text{C}$

Symbol	Parameter	BTA/BTB 10-					Unit
		200B	400B	600B	700B	800B	
$V_{DRM}$	Repetitive Peak off-state Voltage (2)	200	400	600	700	800	V

(1)  $I_G = 1 \text{ A}$   $di/dt = 1 \text{ A}/\mu\text{s}$   
 (2)  $T_j = 110 \text{ }^\circ\text{C}$ .

**THERMAL RESISTANCES**

Symbol	Parameter	Value	Unit
$R_{th(j-a)}$	Junction to Ambient	60	$^\circ\text{C}/\text{W}$
$R_{th(j-c)} \text{ DC}$	Junction to Case for DC	3.9	$^\circ\text{C}/\text{W}$
$R_{th(j-c)} \text{ AC}$	Junction to Case for 360 ° Conduction Angle ( $F = 50 \text{ Hz}$ )	2.9	$^\circ\text{C}/\text{W}$

**GATE CHARACTERISTICS** (maximum values)

$P_{GM} = 40 \text{ W}$  ( $t_p = 10 \mu\text{s}$ )       $I_{GM} = 4 \text{ A}$  ( $t_p = 10 \mu\text{s}$ )  
 $P_{G(AV)} = 1 \text{ W}$        $V_{GM} = 16 \text{ V}$  ( $t_p = 10 \mu\text{s}$ )

**ELECTRICAL CHARACTERISTICS**

Symbol	Test Conditions			Quadrants	Min.	Typ.	Max.	Unit
$I_{GT}$	$T_j = 25 \text{ }^\circ\text{C}$ Pulse Duration > 20 $\mu\text{s}$	$V_D = 12 \text{ V}$	$R_L = 33 \text{ } \Omega$	I-II-III			50	mA
				IV			100	
$V_{GT}$	$T_j = 25 \text{ }^\circ\text{C}$ Pulse Duration > 20 $\mu\text{s}$	$V_D = 12 \text{ V}$	$R_L = 33 \text{ } \Omega$	I-II-III-IV			1.5	V
$V_{GD}$	$T_j = 110 \text{ }^\circ\text{C}$	$V_D = V_{DRM}$	$R_L = 3.3 \text{ k}\Omega$	I-II-III-IV	0.2			V
$I_{H^*}$	$T_j = 25 \text{ }^\circ\text{C}$	$I_T = 100 \text{ mA}$	Gate Open				50	mA
$I_L$	$T_j = 25 \text{ }^\circ\text{C}$ Pulse Duration > 20 $\mu\text{s}$	$V_D = 12 \text{ V}$	$I_G = 200 \text{ mA}$	I-III-IV		50		mA
				II		100		
$V_{TM}^*$	$T_j = 25 \text{ }^\circ\text{C}$	$I_{TM} = 14 \text{ A}$	$t_p = 10 \text{ ms}$				1.5	V
$I_{DRM}^*$	$V_{DRM}$ Specified						0.01	mA
							0.5	
$dv/dt^*$	$T_j = 110 \text{ }^\circ\text{C}$	Gate Open			250	500		V/ $\mu\text{s}$
				Linear Slope up to $V_D = 67\% V_{DRM}$				
$(dv/dt)_c^*$	$T_C = 75 \text{ }^\circ\text{C}$	$V_D = V_{DRM}$	$I_T = 14 \text{ A}$		10			V/ $\mu\text{s}$
				$(di/dt)_c = 4.4 \text{ A/ms}$				
$t_{g1}$	$T_j = 25 \text{ }^\circ\text{C}$ $I_G = 80 \text{ mA}$	$V_D = V_{DRM}$ $di_G/dt = 1 \text{ A}/\mu\text{s}$	$I_T = 14 \text{ A}$	I-II-III-IV		2		$\mu\text{s}$

\* For either polarity of electrode  $A_2$  voltage with reference to electrode  $A_1$ .

**PACKAGE MECHANICAL DATA**

TO 220 AB Plastic

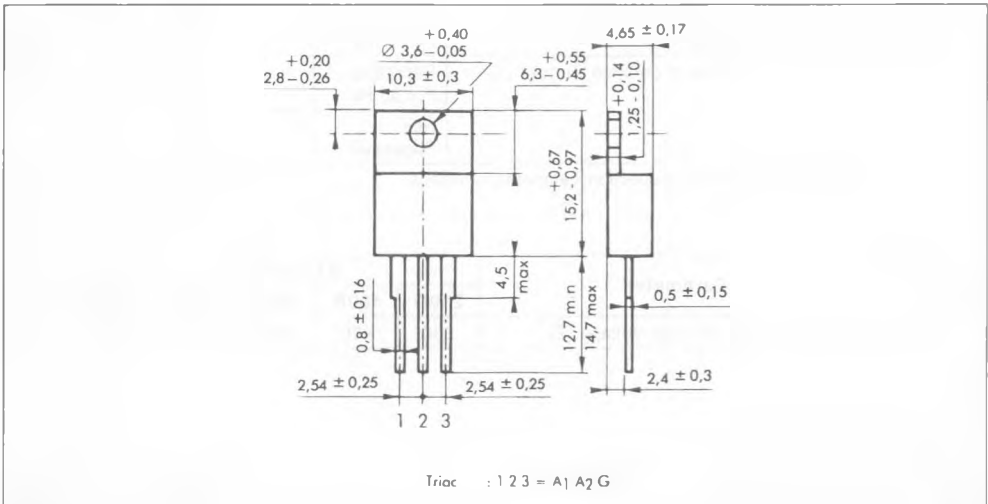

Cooling method : by conduction (method C)  
 Marking : type number  
 Weight : 2 g.

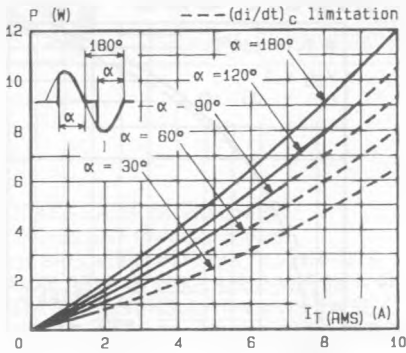

Fig. 1 - Maximum mean power dissipation versus RMS on-state current ( $F = 60$  Hz).

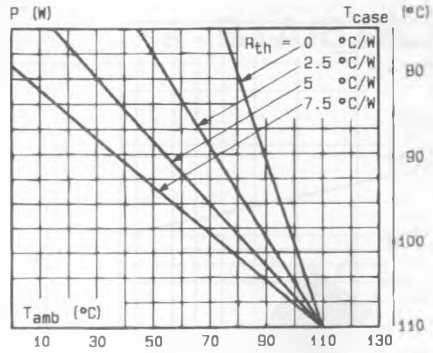

Fig. 2 - Correlation between maximum mean power dissipation and maximum allowable temperatures ( $T_{amb}$  and  $T_{case}$ ) for different thermal resistances heatsink + contact.

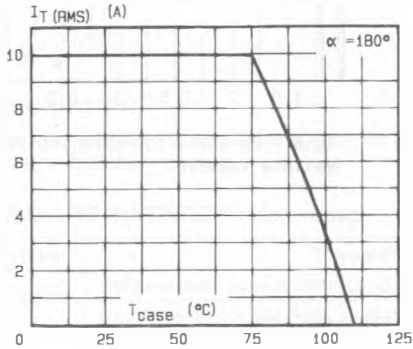

Fig. 3 - RMS on-state current versus case temperature.

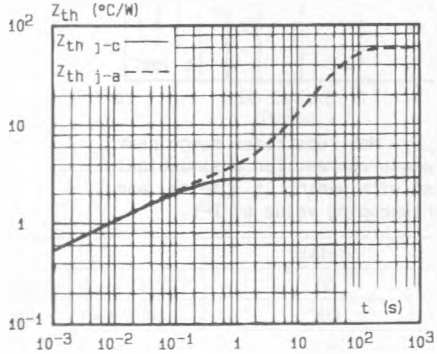

Fig. 4 - Thermal transient impedance junction to case and junction to ambient versus pulse duration.

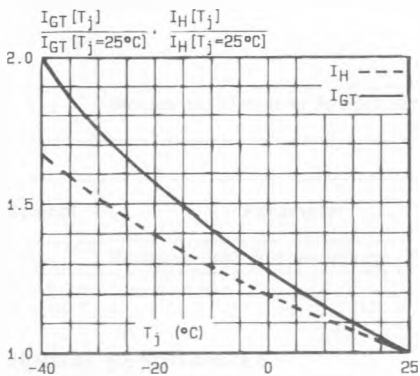

Fig. 5 - Relative variation of gate trigger current and holding current versus junction temperature.

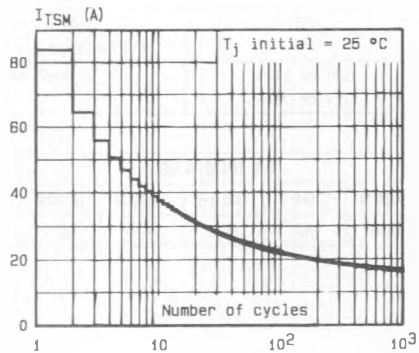

Fig. 6 - Non repetitive surge peak on-state current versus number of cycles.

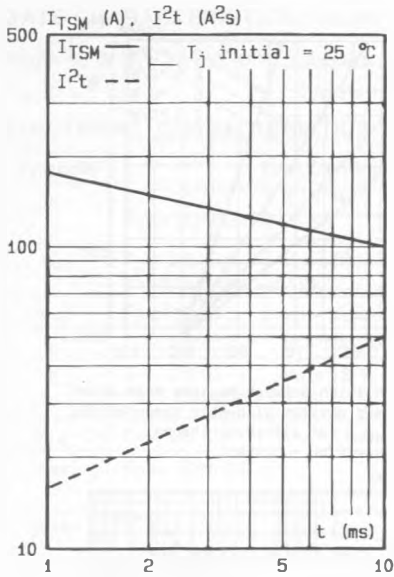

Fig.7 - Non repetitive surge peak on-state current for a sinusoidal pulse with width :  $t \leq 10$  ms, and corresponding value of  $I^2t$ .

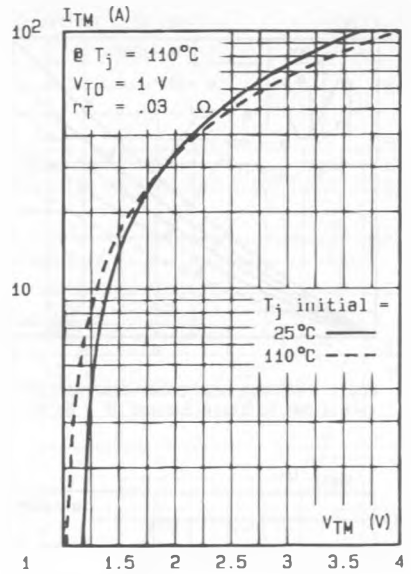

Fig.8 - On-state characteristics (maximum values).