

Phase Control Thyristors

$V_{RRM} = 1200-1800 \text{ V}$
 $I_{T(RMS)} = 600 \text{ A}$
 $I_{T(AV)M} = 380 \text{ A}$

V_{RSM} V_{DSM} V	V_{RRM} V_{DRM} V	Type
1300	1200	CS 300-12io3
1700	1600	CS 300-16io3
1900	1800	CS 300-18io3

Not for new application

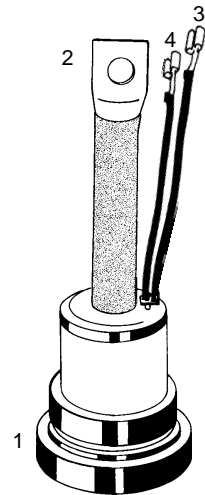
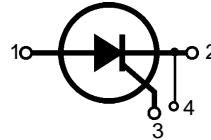

1 = Anode, 2 = Cathode, 3 = Gate, 4 = Auxiliary Cathode

Symbol	Test Conditions	Maximum Ratings	
$I_{T(RMS)}$	$T_{VJ} = T_{VJM}$	600	A
$I_{T(AV)M}$	$T_{case} = 85^{\circ}\text{C}; 180^{\circ}$ sine	330	A
	$T_{case} = 75^{\circ}\text{C}; 180^{\circ}$ sine	380	A
I_{TSM}	$T_{VJ} = 45^{\circ}\text{C}; V_R = 0$	t = 10 ms (50 Hz), sine	8500 A
		t = 8.3 ms (60 Hz), sine	9000 A
	$T_{VJ} = T_{VJM}; V_R = 0$	t = 10 ms (50 Hz), sine	8000 A
		t = 8.3 ms (60 Hz), sine	8500 A
I^2t	$T_{VJ} = 45^{\circ}\text{C}; V_R = 0$	t = 10 ms (50 Hz), sine	360 000 A ² s
		t = 8.3 ms (60 Hz), sine	340 000 A ² s
	$T_{VJ} = T_{VJM}; V_R = 0$	t = 10 ms (50 Hz), sine	320 000 A ² s
		t = 8.3 ms (60 Hz), sine	303 500 A ² s
$(di/dt)_{cr}$	$T_{VJ} = T_{VJM}; f = 50\text{Hz}; t_p = 200\mu\text{s}; V_D = 2/3 V_{DRM}; I_G = 1 \text{ A}; di_G/dt = 1 \text{ A}/\mu\text{s}$	repetitive, $I_T = 1000 \text{ A}$	100 A/ μs
		non repetitive, $I_T = I_{T(AV)M}$	500 A/ μs
$(dv/dt)_{cr}$	$T_{VJ} = T_{VJM}; R_{GK} = \infty; \text{method 1 (linear voltage rise)}$	$V_{DR} = 2/3 V_{DRM}$	1000 V/ μs
P_{GM}	$T_{VJ} = T_{VJM}$	$t_p = 30 \mu\text{s}$	120 W
	$I_T = I_{T(AV)M}$	$t_p = 10 \text{ ms}$	10 W
V_{RGM}			10 V
T_{VJ}		-40...+125	$^{\circ}\text{C}$
T_{VJM}		125	$^{\circ}\text{C}$
T_{stg}		-40...+125	$^{\circ}\text{C}$
M_d	Mounting torque		3.5 Nm
			31 lb.in.
Weight			500 g

Features

- Thyristor for line frequencies
- International flat base package
- Planar glassivated chip
- Long-term stability of blocking currents and voltages

Applications

- Motor control
- Power converter
- AC power controller

Advantages

- Space and weight savings
- Simple mounting
- Improved temperature and power cycling

Dimensions in mm (1 mm = 0.0394")

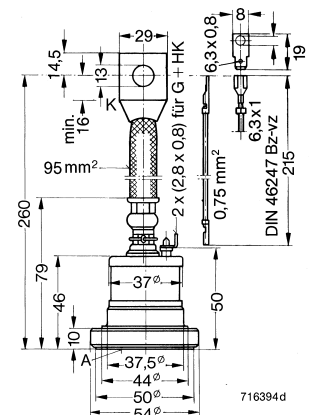

Data according to IEC 60747

IXYS reserves the right to change limits, test conditions and dimensions

Symbol	Test Conditions	Characteristic Values
I_R, I_D	$T_{VJ} = T_{VJM}; V_R = V_{RRM}; V_D = V_{DRM}$	≤ 40 mA
V_T	$I_T = 1000$ A; $T_{VJ} = 25^\circ\text{C}$	≤ 1.43 V
V_{T0}	For power-loss calculations only ($T_{VJ} = 125^\circ\text{C}$)	1.0 V
r_T		0.43 m Ω
V_{GT}	$V_D = 6$ V; $T_{VJ} = 25^\circ\text{C}$ $T_{VJ} = -40^\circ\text{C}$	≤ 2.0 V ≤ 2.8 V
I_{GT}	$V_D = 6$ V; $T_{VJ} = 25^\circ\text{C}$ $T_{VJ} = -40^\circ\text{C}$	≤ 150 mA ≤ 250 mA
V_{GD}	$T_{VJ} = T_{VJM}; V_D = 2/3 V_{DRM}$	≤ 0.2 V
I_{GD}		≤ 1 mA
I_L	$T_{VJ} = 25^\circ\text{C}; t_p = 10$ μs $I_G = 0.7$ A; $di_G/dt = 0.7$ A/ μs	≤ 100 mA
I_H	$T_{VJ} = 25^\circ\text{C}; V_D = 6$ V; $R_{GK} = \infty$	≤ 100 mA
t_{gd}	$T_{VJ} = 25^\circ\text{C}; V_D = 1/2 V_{DRM}$ $I_G = 0.7$ A; $di_G/dt = 0.7$ A/ μs	≤ 2 μs
t_q	$T_{VJ} = T_{VJM}; I_T = 330$ A, $t_p = 300$ μs ; $di/dt = -20$ A/ μs $V_R = 100$ V; $dv/dt = 20$ V/ μs ; $V_D = 2/3 V_{DRM}$	typ. 150 μs
R_{thJC}	DC current	0.09 K/W
R_{thJH}	DC current	0.12 K/W
d_s	Creepage distance on surface	1.55 mm
d_A	Strike distance through air	1.55 mm
a	Max. acceleration, 50 Hz	50 m/s ²

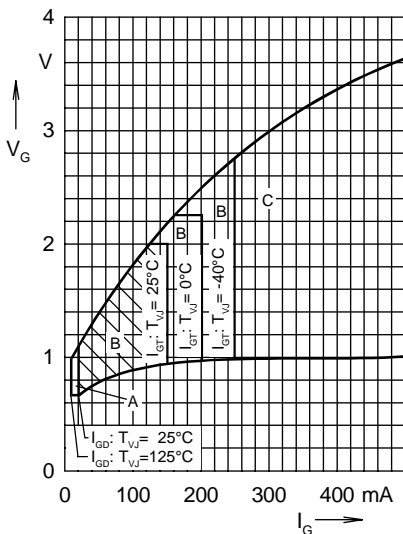

Fig. 1 Gate voltage and gate current
Triggering:
A = no; B = possible; C = safe

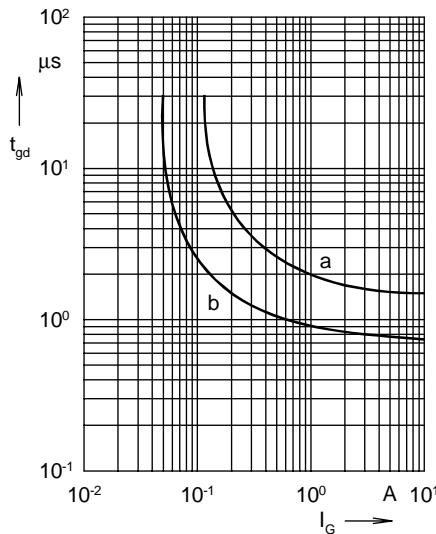

Fig. 2 Gate controlled delay time t_{gd}
a = limit; b = typical

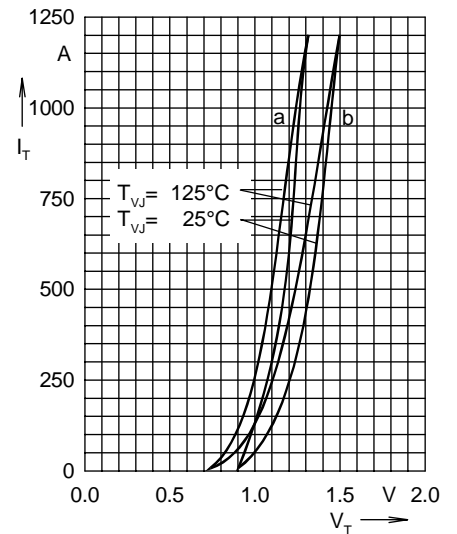

Fig. 3 On-state characteristics
a = typical; b = limit

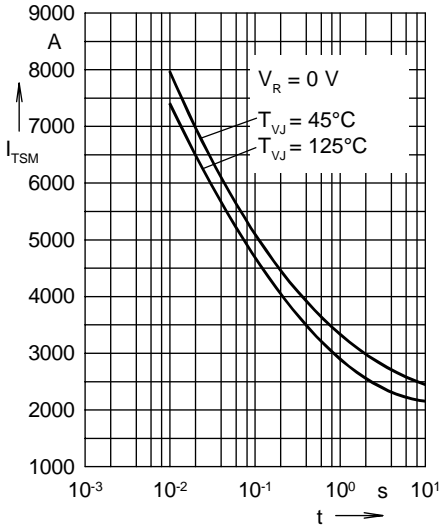

Fig. 4 Surge overload current
 I_{TSM} : crest value, t: duration

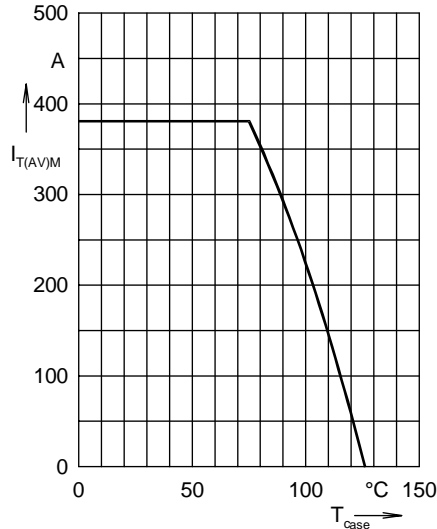

Fig. 5 Maximum forward current at case temperature 180° sine

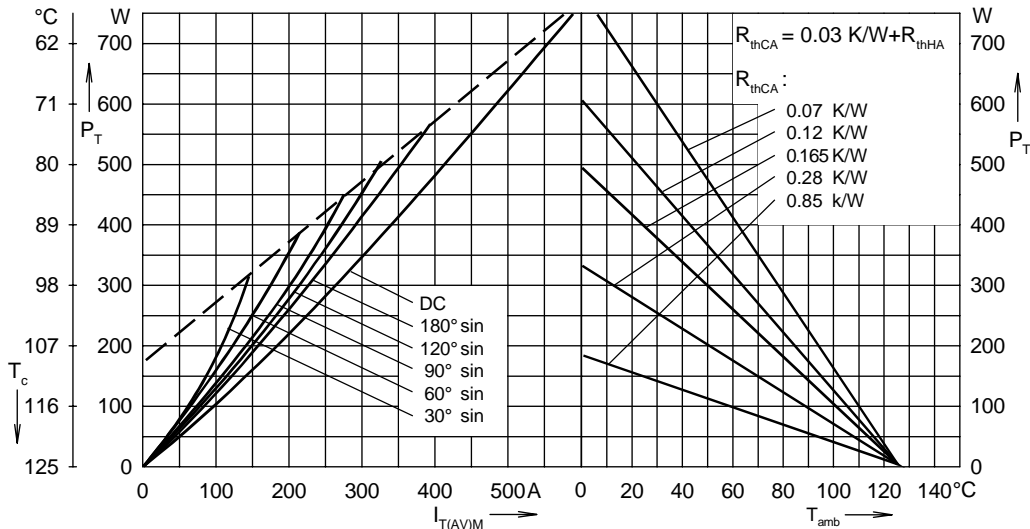

Fig. 6 Power dissipation versus on-state current and ambient temperature (sinusoidal current)

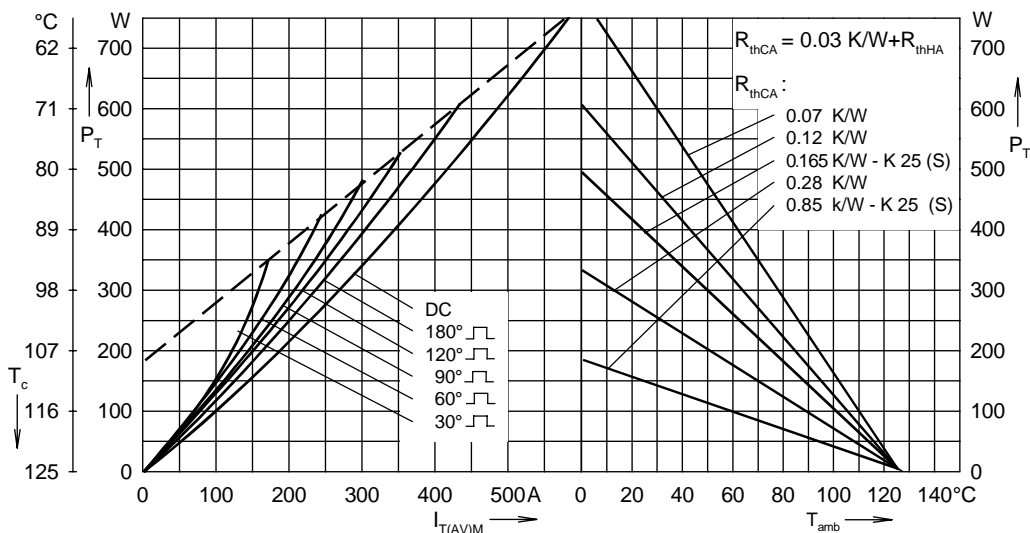

Fig. 7 Power dissipation versus on-state current and ambient temperature (rectangular current)