

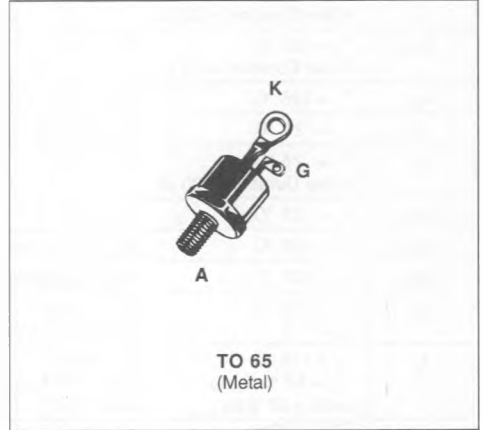

FAST SWITCHING THYRISTORS

- GLASS PASSIVATED CHIP
- HIGH STABILITY AND RELIABILITY
- EXCELLENT SURGE CAPABILITY
- HIGH di/dt AND dv/dt RATINGS
- $t_q \leq 40 \mu s$



DESCRIPTION

SCR designed for high frequency power switching applications.

ABSOLUTE RATINGS (limiting values)

Symbol	Parameter	Value	Unit
$I_{T(RMS)}$	RMS on-state Current (1)	$T_C = 65^\circ C$ 63	A
$I_{T(AV)}$	Mean on-state Current (1)	$T_C = 65^\circ C$ 40	A
I_{TSM}	Non Repetitive Surge Peak on-state Current (T_j initial $\leq 125^\circ C$) (2)	$t = 8.3 \text{ ms}$	700
		$t = 10 \text{ ms}$	670
$I^2 t$	$I^2 t$ Value for Fusing	$t = 10 \text{ ms}$	2245
di/dt	Critical Rate of Rise of on-state Current (3)	200	A/ μs
T_{stg} T_j	Storage and Operating Junction Temperature Range	- 40 to 150 - 40 to 125	$^\circ C$ $^\circ C$

Symbol	Parameter	TGF148-							Unit
		600B	700B	800B	900B	1000B	1100B	1200B	
V_{DRM} V_{RRM}	Repetitive Peak off-state Voltage (4)	600	700	800	900	1000	1100	1200	V

(1) Single phase circuit, 180° conduction angle.
 (2) Half sine wave
 (3) $I_G = 1 \text{ A}$ $di/dt = 1 \text{ A}/\mu s$
 (4) $T_j = 125^\circ C$.

THERMAL RESISTANCES

Symbol	Parameter	Value	Unit
$R_{th(j-c)}$	Junction-case for D.C.	0.61	$^\circ C/W$
$R_{th(c-h)}$	Contact (case to heatsink)	0.30	$^\circ C/W$

GATE CHARACTERISTICS (maximum values)

$P_{GM} = 80 \text{ W}$ ($t_p = 500 \mu\text{s}$) $I_{FGM} = 10 \text{ A}$ ($t_p = 500 \mu\text{s}$) $V_{RGM} = 5 \text{ V}$
 $P_G(AV) = 2 \text{ W}$ $V_{FGM} = 15 \text{ V}$ ($t_p = 500 \mu\text{s}$)

ELECTRICAL CHARACTERISTICS

Symbol	Test Conditions			Min.	Typ.	Max.	Unit
I_{GT}	$T_j = 25 \text{ }^\circ\text{C}$ Pulse Duration > 20 μs	$V_D = 12 \text{ V}$	$R_L = 33 \text{ } \Omega$			150	mA
V_{GT}	$T_j = 25 \text{ }^\circ\text{C}$ Pulse Duration > 20 μs	$V_D = 12 \text{ V}$	$R_L = 33 \text{ } \Omega$			1.5	V
V_{GD}	$T_j = 125 \text{ }^\circ\text{C}$	$V_D = V_{DRM}$	$R_L = 3.3 \text{ k}\Omega$	0.2			V
I_H	$T_j = 25 \text{ }^\circ\text{C}$	$I_T = 500 \text{ mA}$	Gate Open			200	mA
I_L	$T_j = 25 \text{ }^\circ\text{C}$ Pulse Duration > 20 μs	$V_D = 12 \text{ V}$	$I_G = 300 \text{ mA}$			400	mA
V_{TM}	$T_j = 25 \text{ }^\circ\text{C}$	$I_{TM} = 500 \text{ A}$	$t_p = 10 \text{ ms}$			4	V
I_{DRM}	$T_j = 125 \text{ }^\circ\text{C}$	V_{DRM} Specified				12	mA
I_{RRM}	$T_j = 125 \text{ }^\circ\text{C}$	V_{RRM} Specified				12	mA
t_{gt}	$T_j = 25 \text{ }^\circ\text{C}$ $I_G = 1 \text{ A}$	$V_D = V_{DRM}$ $di_G/dt = 10 \text{ A}/\mu\text{s}$	$I_T = 500 \text{ A}$		2		μs
t_q	$T_j = 125 \text{ }^\circ\text{C}$ $V_D = 67 \% V_{DRM}$ $dv/dt = 20 \text{ V}/\mu\text{s}$	$I_T = 500 \text{ A}$ $di/dt = 30 \text{ A}/\mu\text{s}$ Gate Open	$V_R = 50 \text{ V}$			40	μs
dv/dt^*	$T_j = 125 \text{ }^\circ\text{C}$ Linear Slope up to $V_D = 67 \% V_{DRM}$	Gate Open		200			V/ μs

* For higher guaranteed values, please consult us.

PACKAGE MECHANICAL DATA

TO 65 Metal

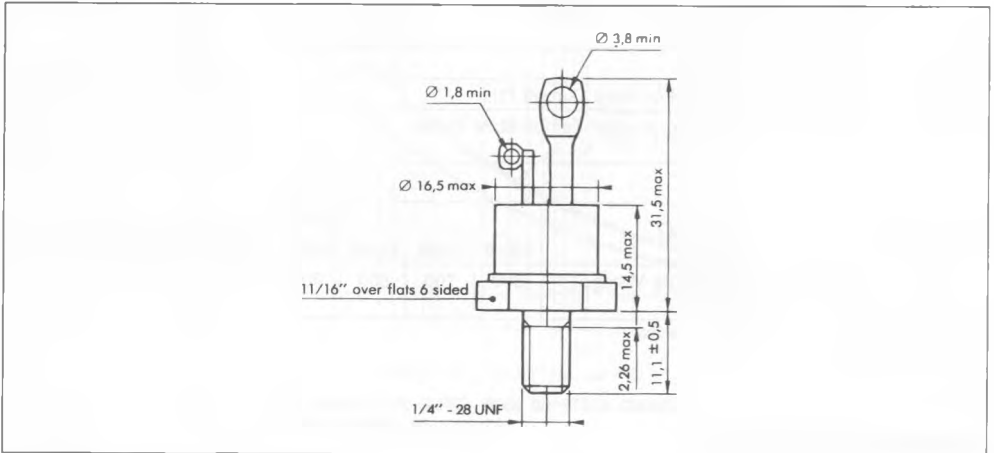

Cooling method : by conduction (method C)
 Marking : type number
 Weight : 19 g without accessories
 Polarity : anode to case
 Stud torque : 3.5 mAN min - 3.8 mAN max.

SINUSOIDAL CURRENT PULSE DATA

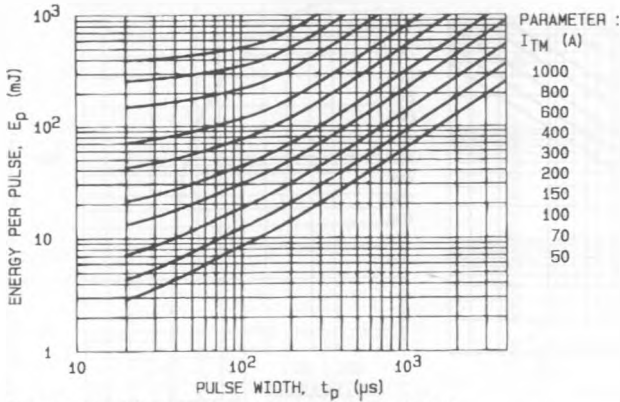

FIG.1 - ENERGY PER PULSE FOR SINUSOIDAL PULSES.

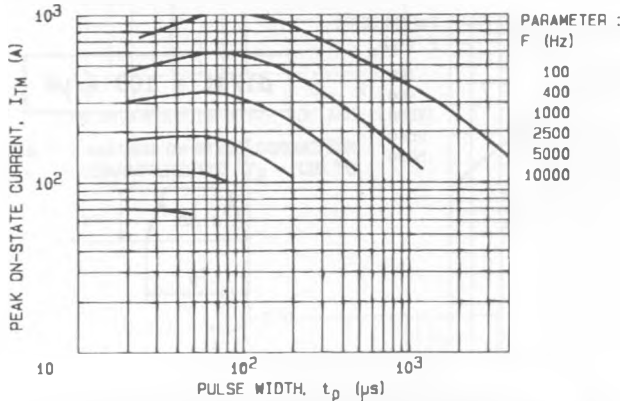

FIG.2 - MAXIMUM ALLOWABLE PEAK ON-STATE CURRENT VERSUS PULSE WIDTH FOR $T_c = 85$ °C.

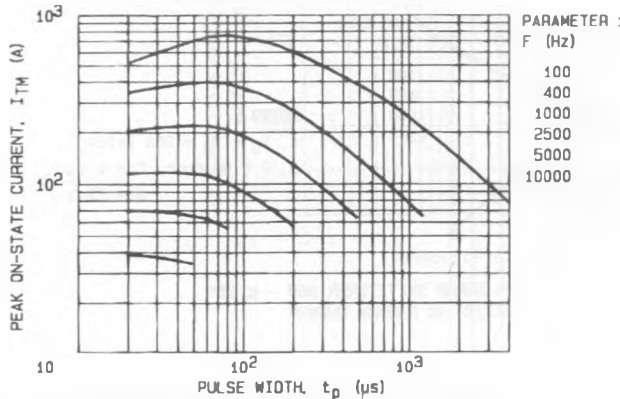
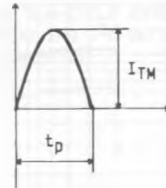

FIG.3 - MAXIMUM ALLOWABLE PEAK ON-STATE CURRENT VERSUS PULSE WIDTH FOR $T_c = 80$ °C.

NOTES :

1. $V_D = V_R = 600$ Volts.
2. A.C Snubber, $C = 0.1 \mu F$,
 $R = 33 \Omega$.

TRAPEZOIDAL CURRENT PULSE DATA

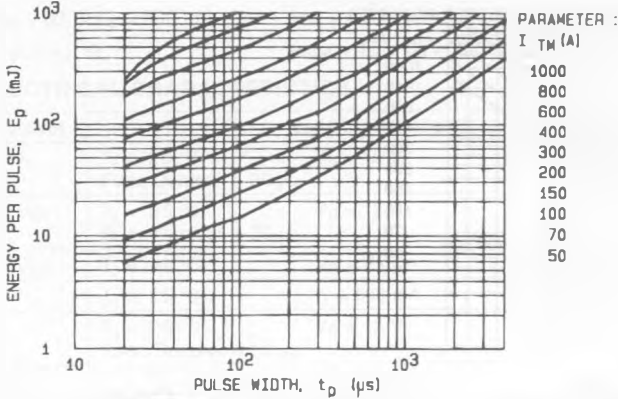

FIG.4 - ENERGY PER PULSE FOR TRAPEZOIDAL PULSES.

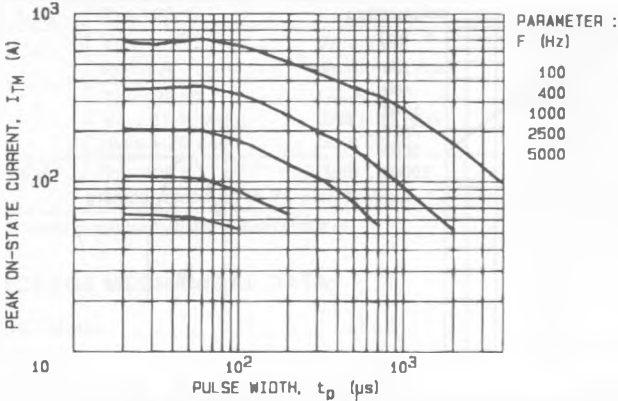

FIG.6 - MAXIMUM ALLOWABLE PEAK ON-STATE CURRENT VERSUS PULSE WIDTH FOR $T_D = 85^\circ\text{C}$.

$di/dt = 100 \text{ A}/\mu\text{s}$

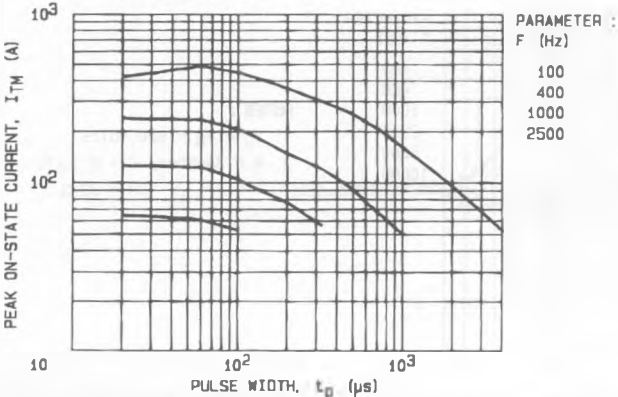
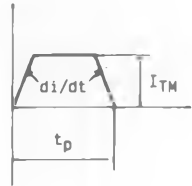

FIG.6 - MAXIMUM ALLOWABLE PEAK ON-STATE CURRENT VERSUS PULSE WIDTH FOR $T_D = 90^\circ\text{C}$.

NOTES :

1. $V_D = V_R = 600$ Volts.
2. R.C Snubber, $C = 0.1 \mu\text{F}$,
 $R = 33 \Omega$.

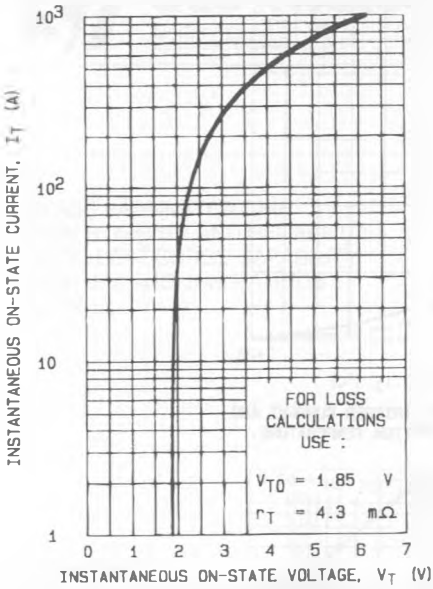

FIG.7 - MAXIMUM ON-STATE CONDUCTION CHARACTERISTIC ($T_J = 125^\circ\text{C}$).

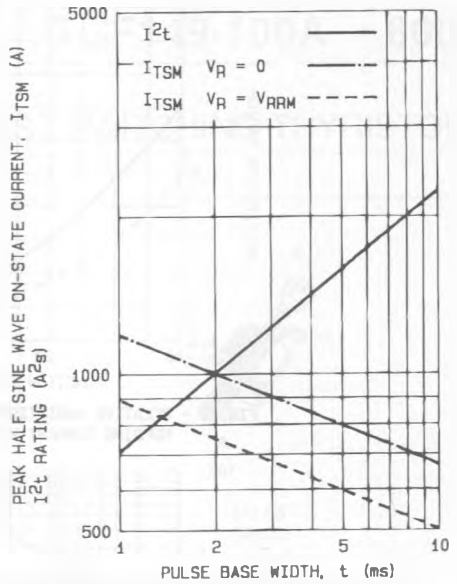

FIG.8 - NON REPETITIVE SUB-CYCLE SURGE ON-STATE CURRENT AND I^2t RATING (INITIAL $T_J = 125^\circ\text{C}$).

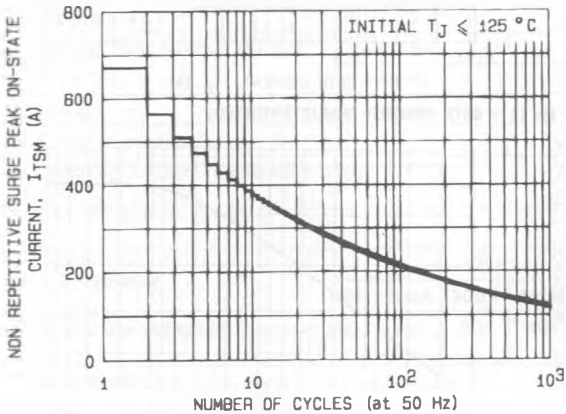

FIG.9 - NON REPETITIVE SURGE PEAK ON-STATE CURRENT VERSUS NUMBER OF CYCLES.

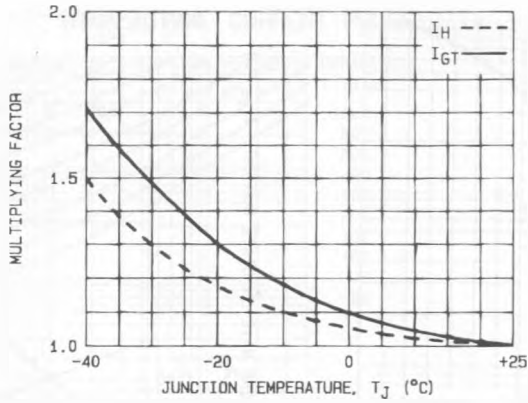

FIG.10 - RELATIVE VARIATION OF GATE TRIGGER CURRENT AND HOLDING CURRENT VERSUS JUNCTION TEMPERATURE.

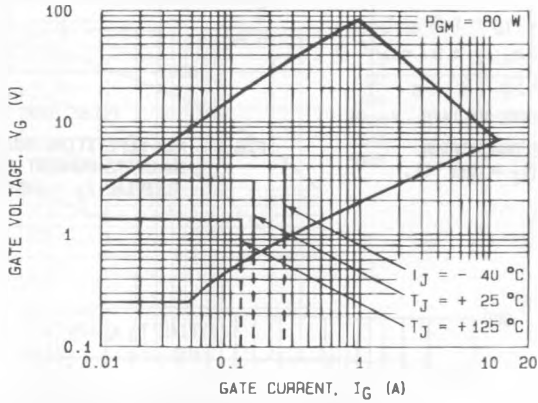

FIG.11 - GATE TRIGGER CHARACTERISTICS.

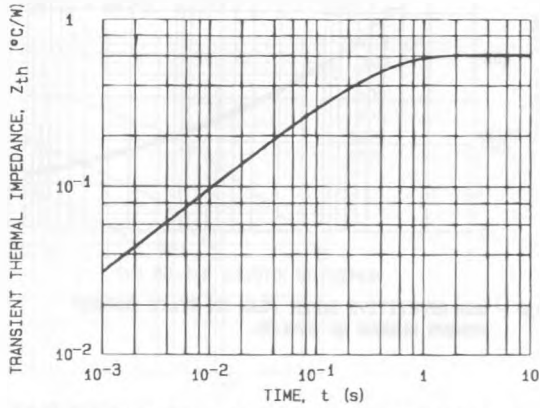

FIG.12 - TRANSIENT THERMAL IMPEDANCE JUNCTION TO CASE.