

# Diora OTV-C200

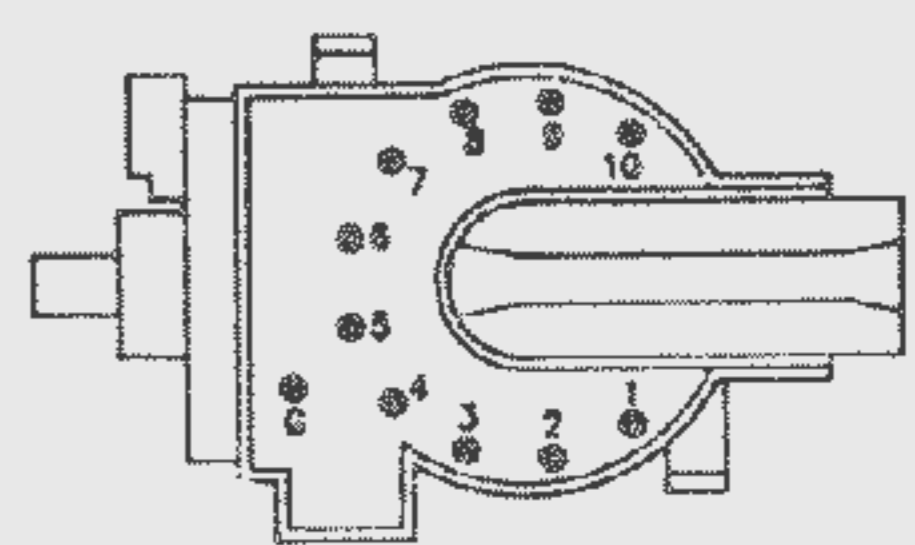

<http://www.schematy-tv.prv.pl>

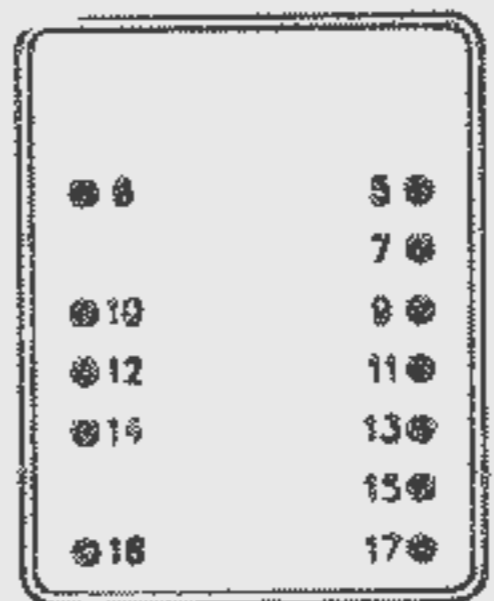
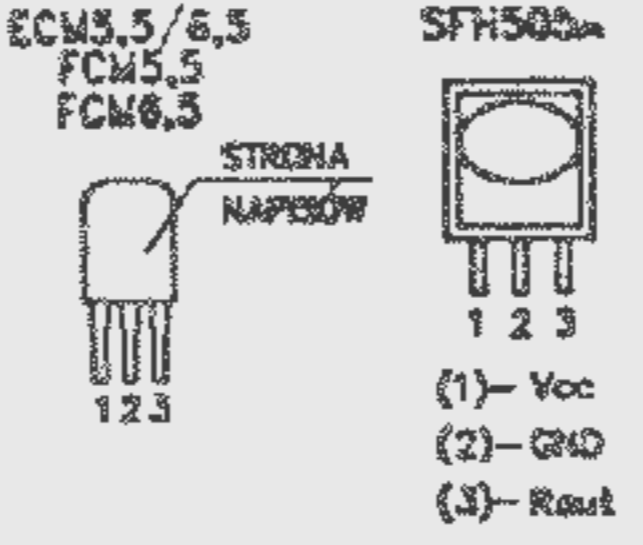
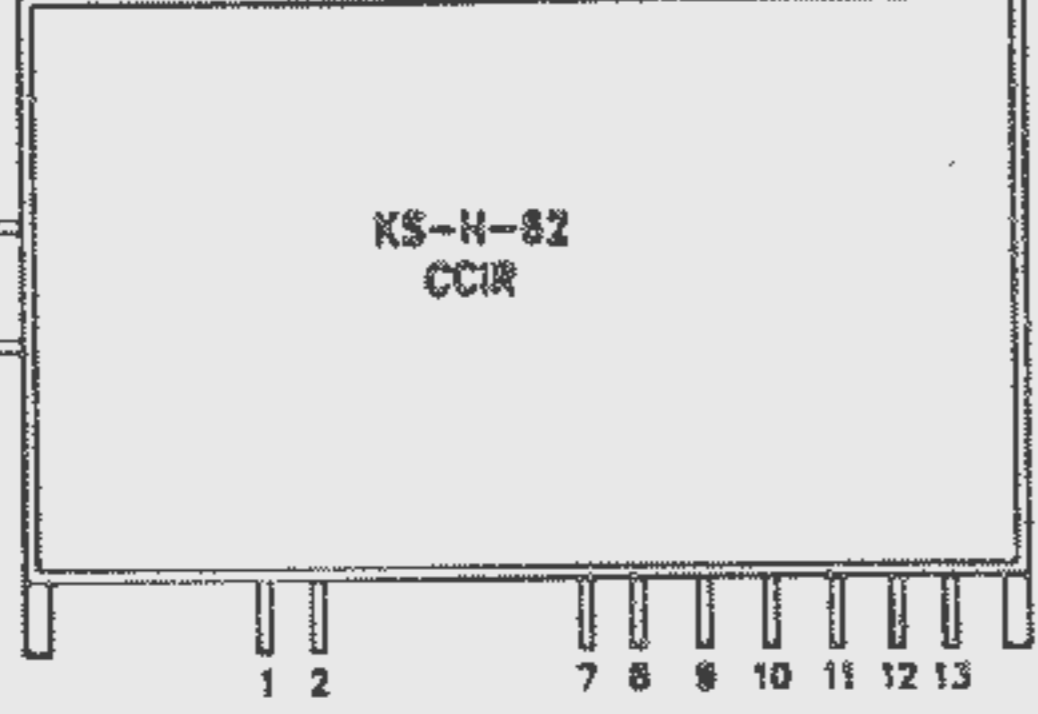
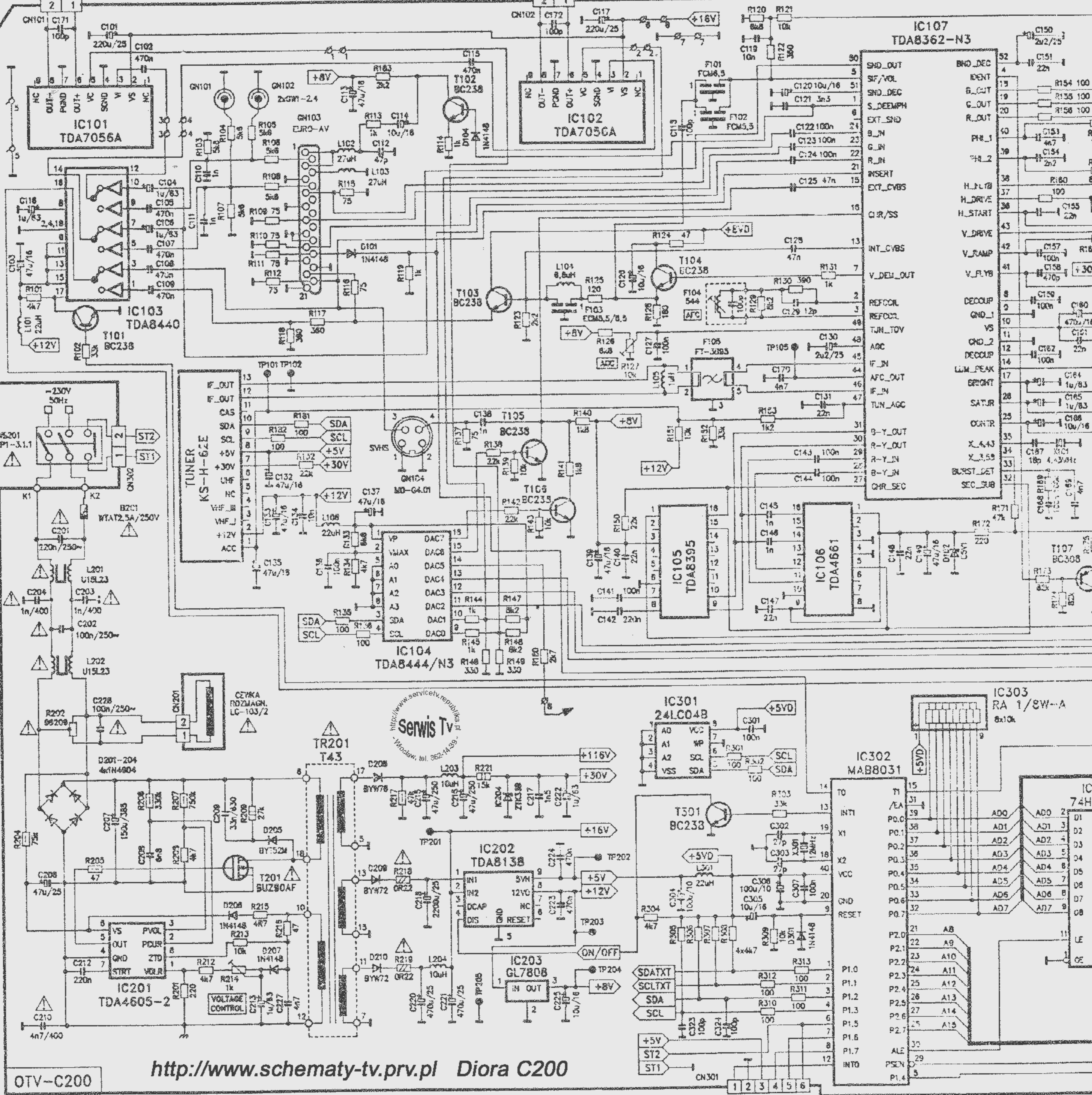

<http://www.schematy-tv.prv.pl> Diora C200

OTV-C200

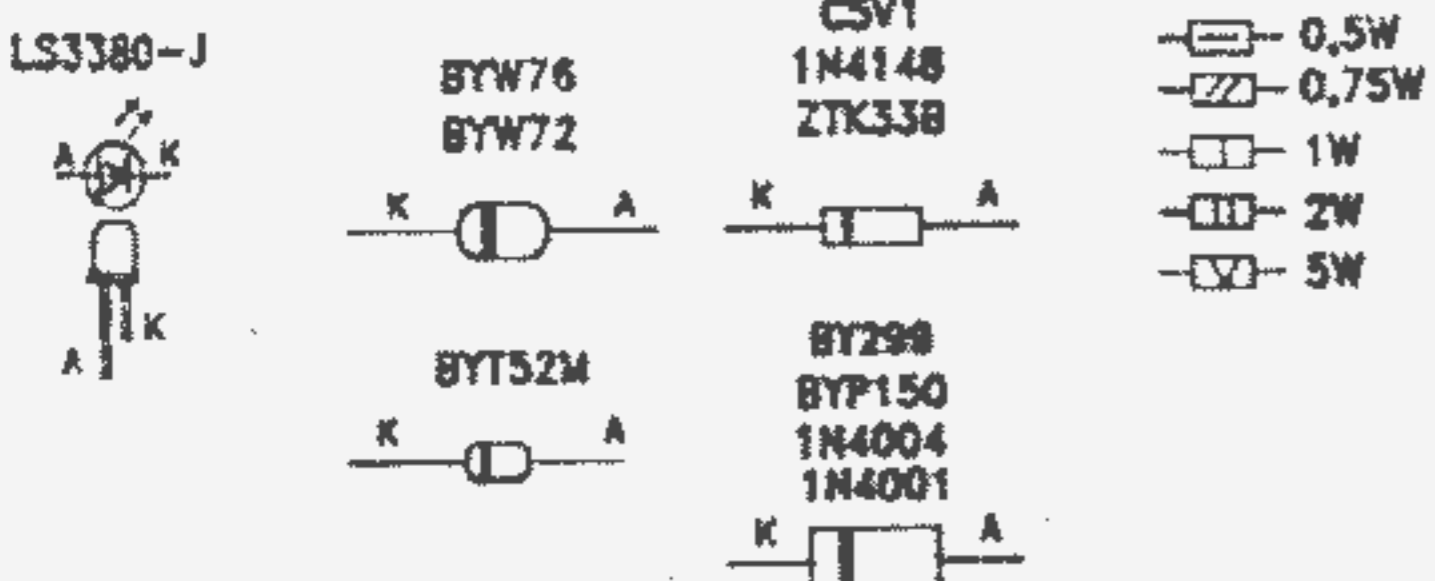

<http://www.schematy-tv.prv.pl>  
Diora OTV-C200

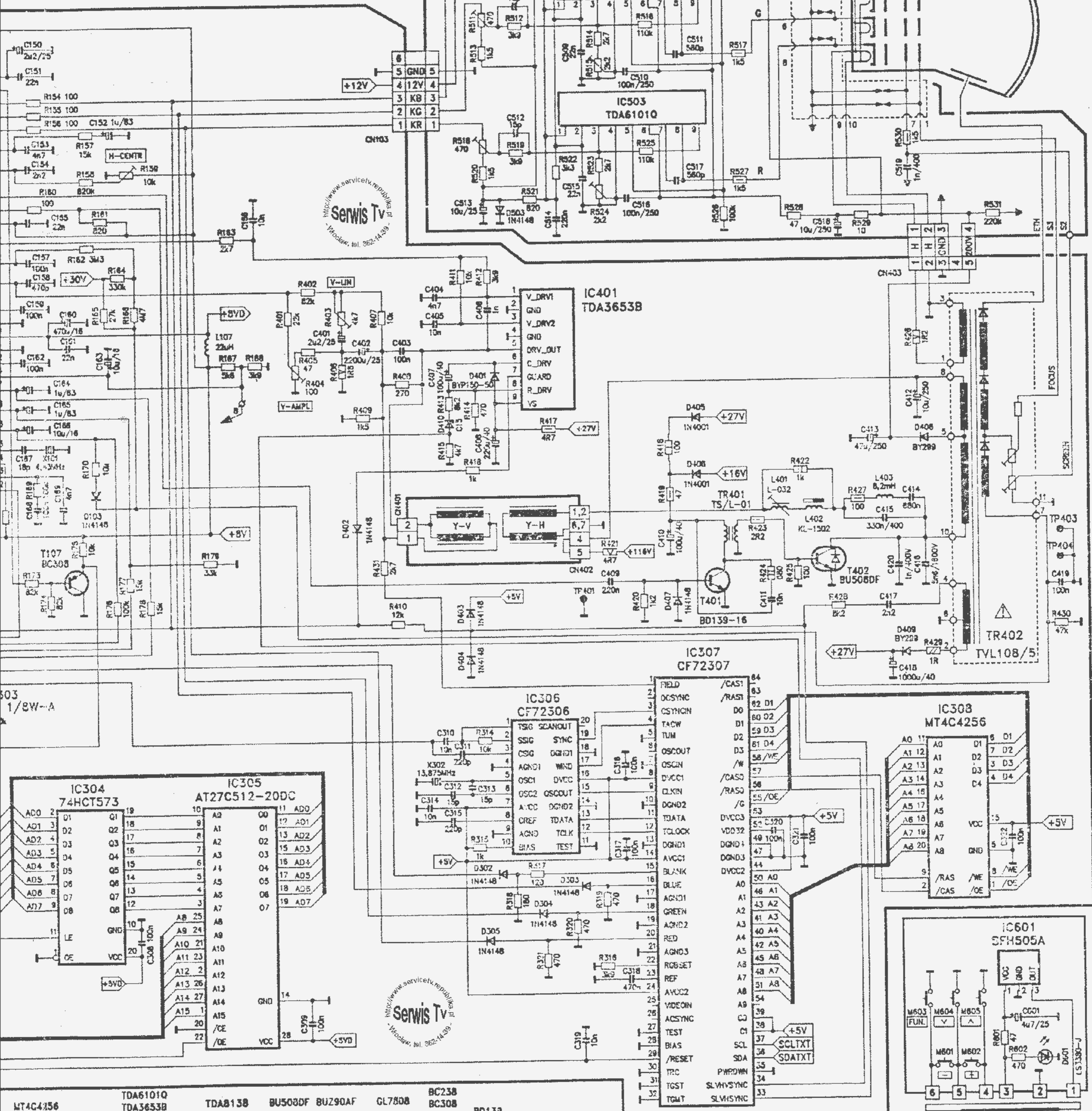
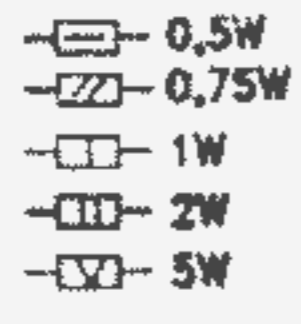

serwis Tv  
Wrocław, tel. 362-14-39

serwis Tv  
Wrocław, tel. 362-14-39

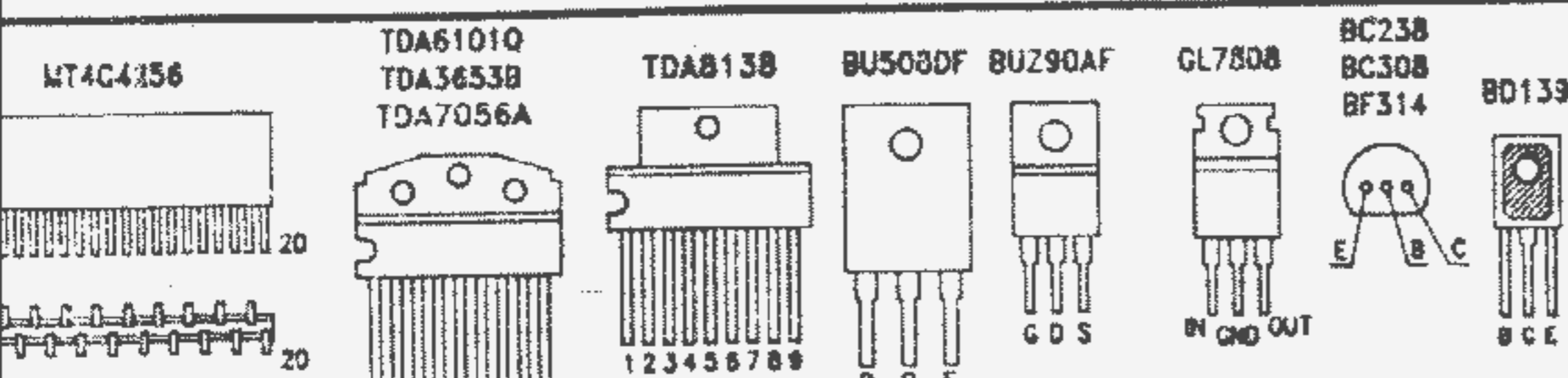

Diora OTV-C200  
<http://www.schematy-tv.prv.pl>