

11. Schematic Diagrams

11-1 ONECHIP

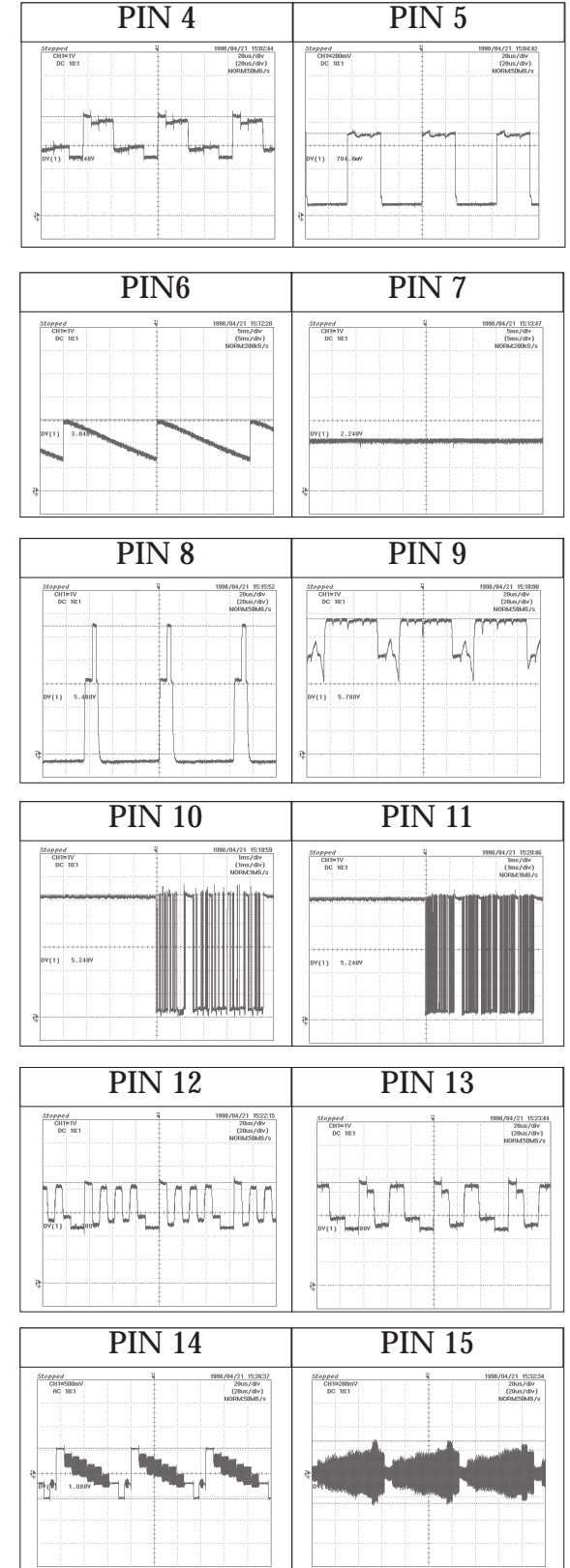

11-3 POWER / CRT / VERTICAL / HORIZONTAL

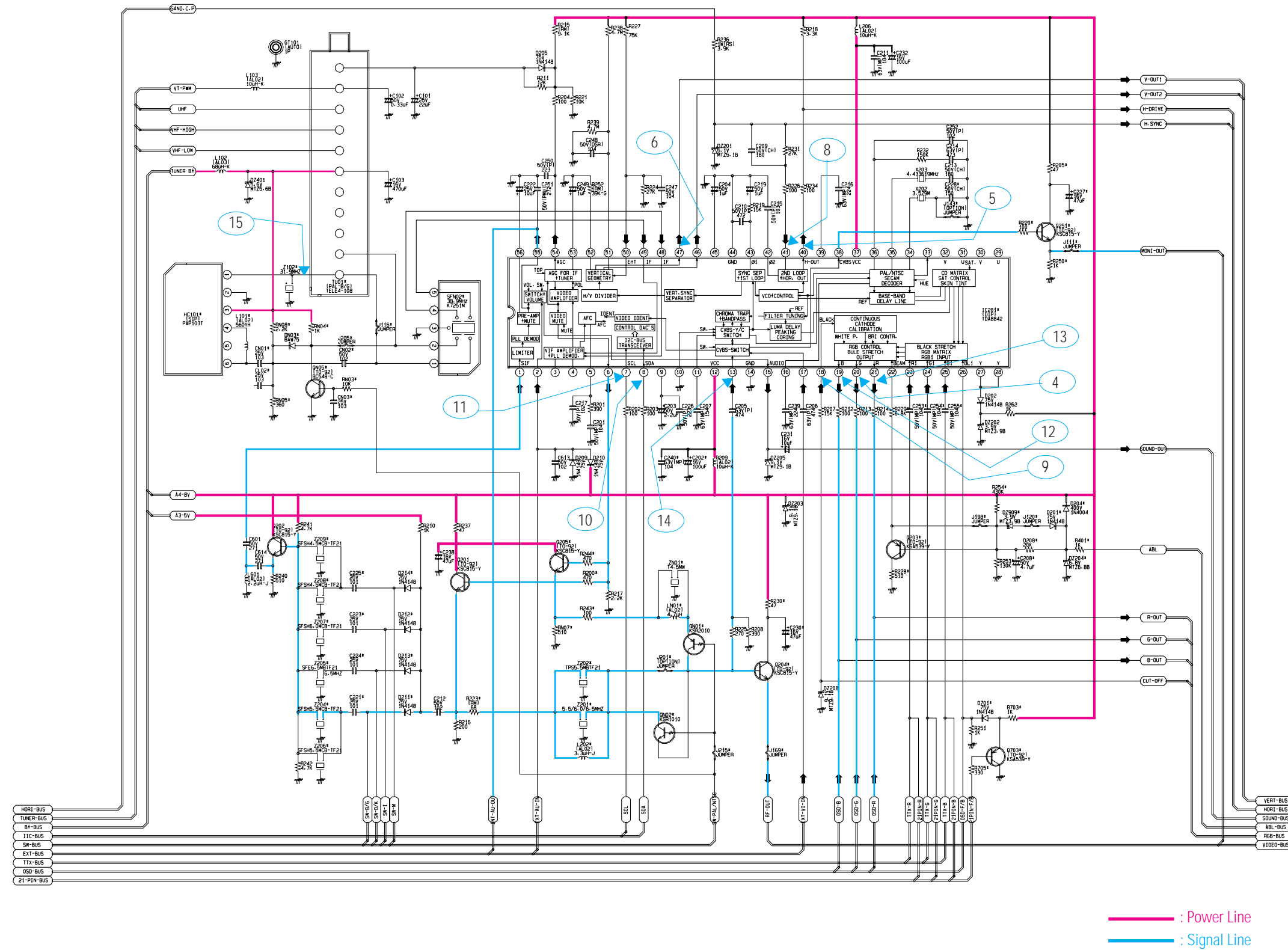
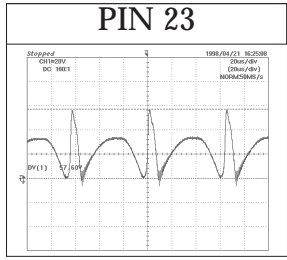
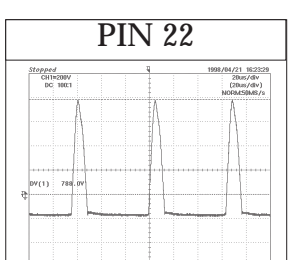
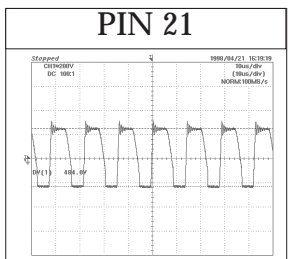
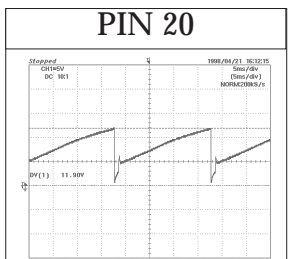
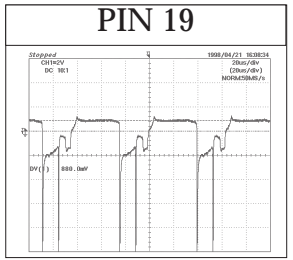
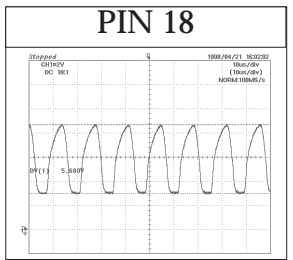
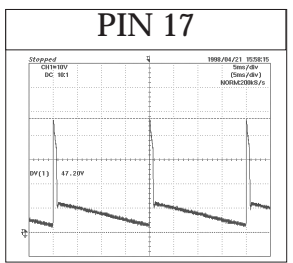
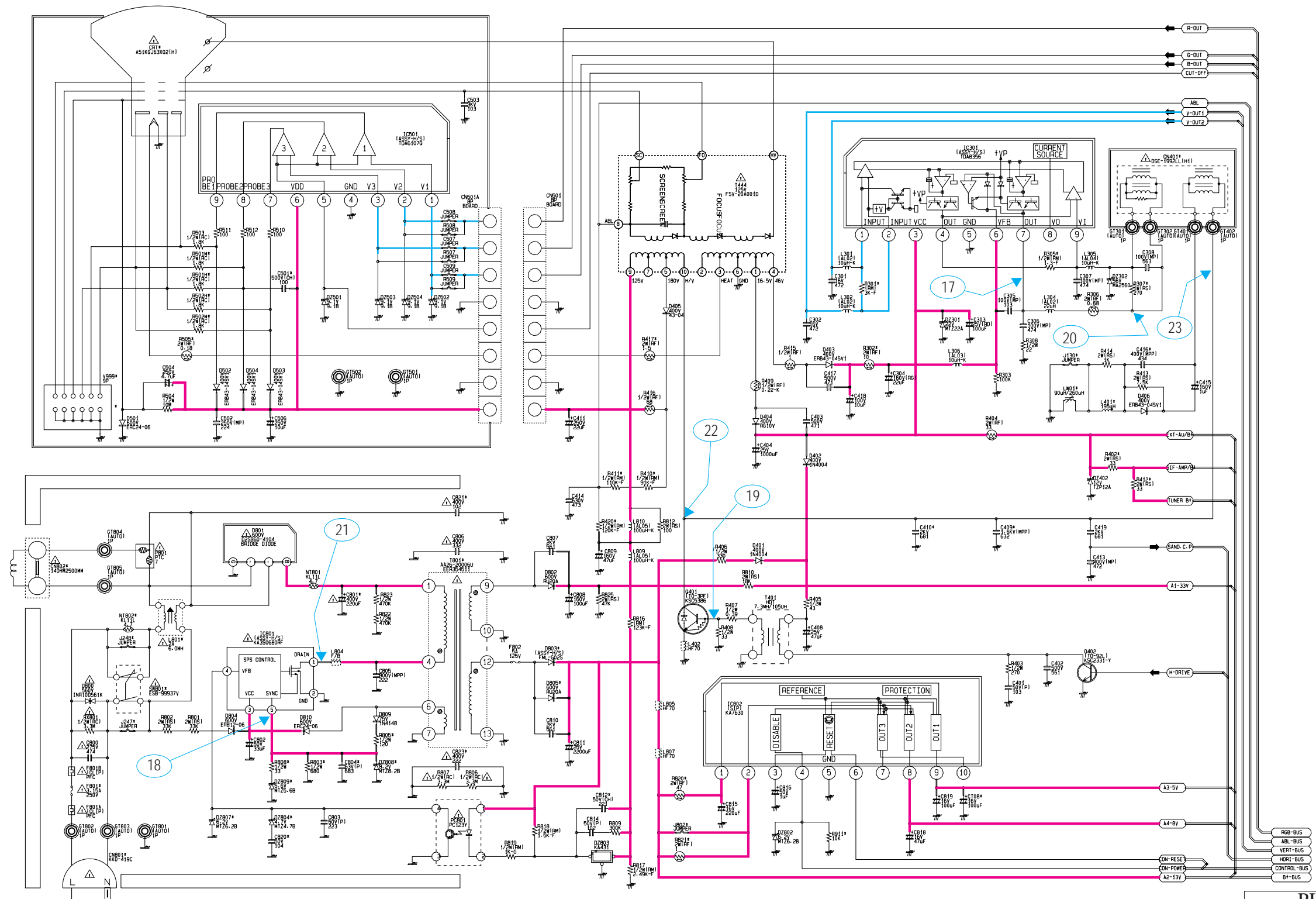

— : Power Line
 — : Signal Line

11-4 MICOM (NON-TTX, TTX)

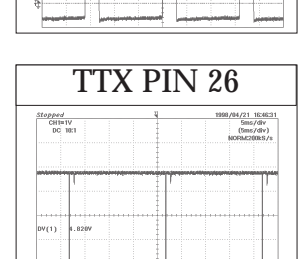
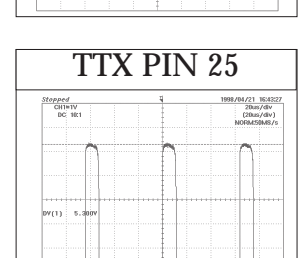
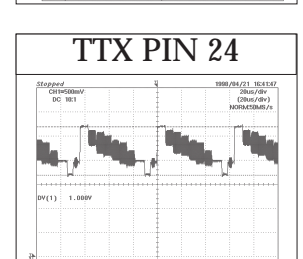
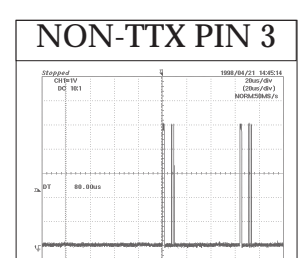
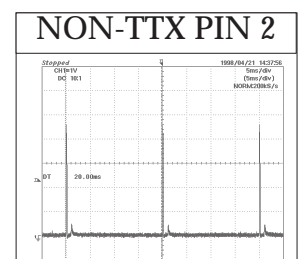
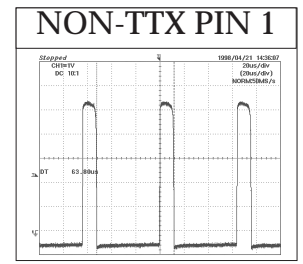
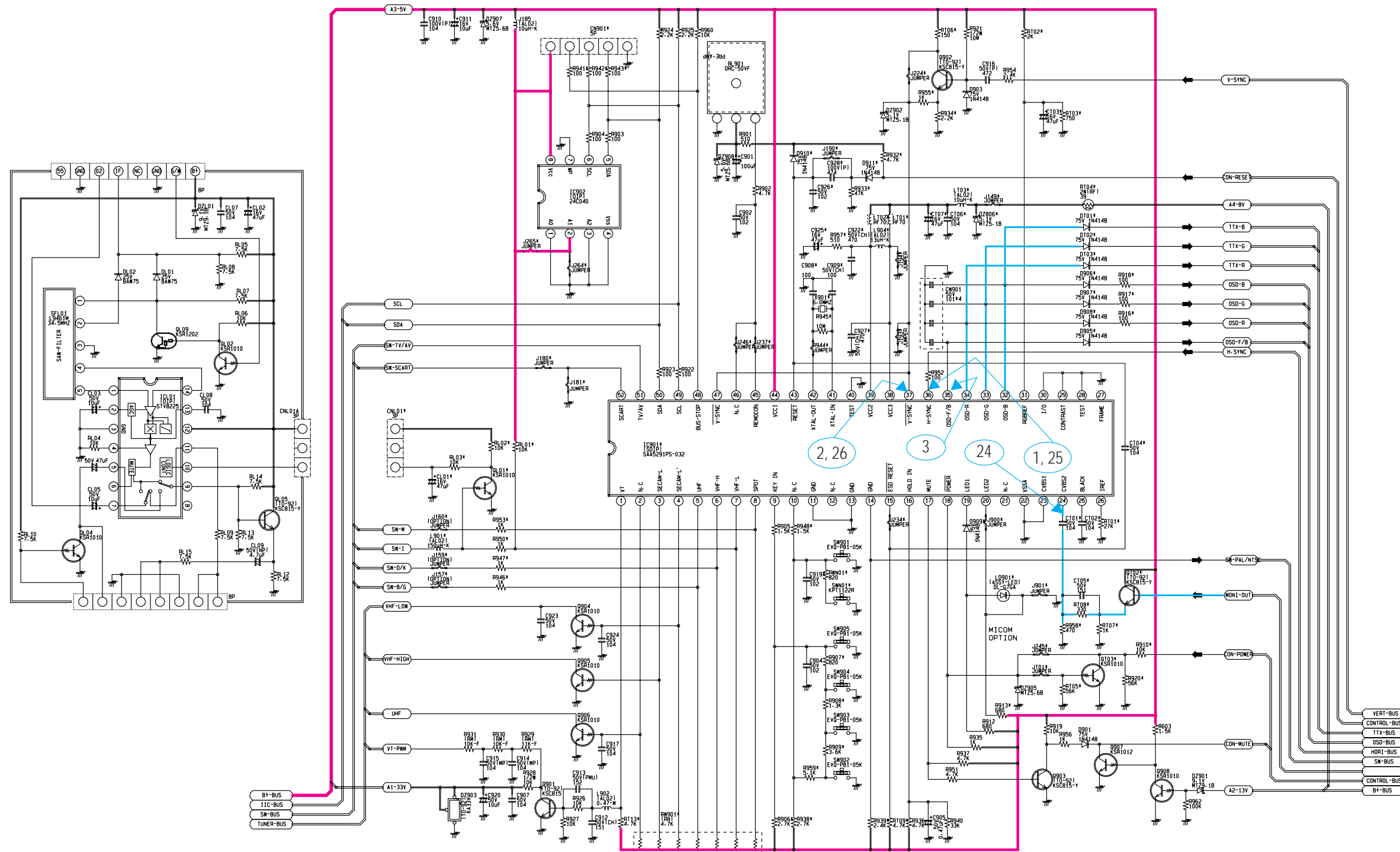

— : Power Line
 — : Signal Line